

KNOW YOUR PRODUCT

CORDLESS MITRE SAW

- | | |
|----------------------|------------------------|
| 1 Handle Lock Button | 9 Mitre Guide |
| 2 Spindle Lock | 10 Mitre Locking Knob |
| 3 Head Locking Pin | 11 Blade |
| 4 Material Clamp | 12 Lower Blade Guard |
| 5 Extension Supports | 13 Depth Stop |
| 6 On/Off Trigger | 14 Dust Port |
| 7 Bevel Guide | 15 Bevel Locking Lever |
| 8 Rear Fence | 16 Material Stop |

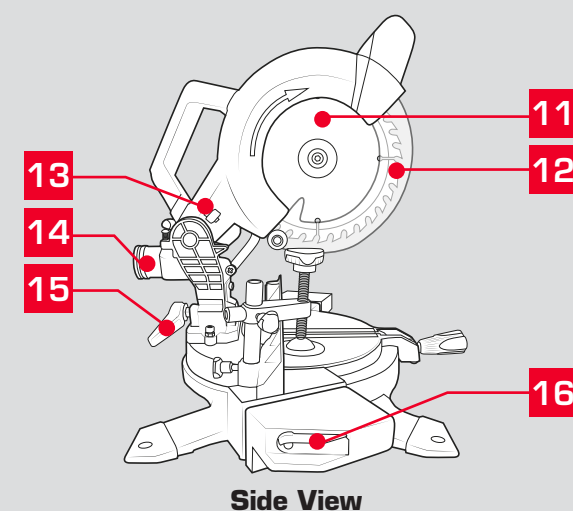
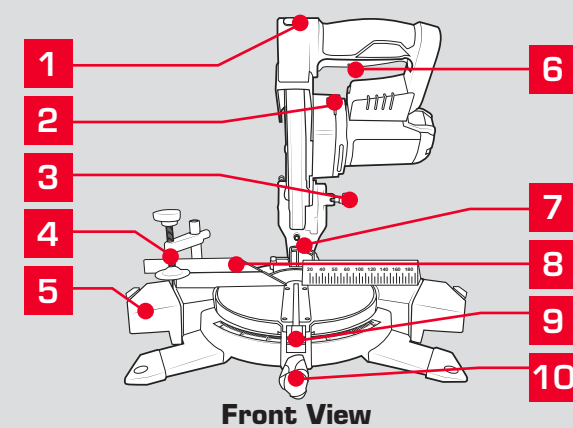

BATTERY & CHARGER

This tool is compatible with all battery and chargers from the Ozito Power X Change Range.

For optimal performance, we recommend the use of a 3.0Ah battery or higher to operate this Power X Change Mitre Saw.

ONLINE MANUAL
Scan this QR Code with your mobile device to take you to the online manual.



SETUP & PREPARATION

1. BEFORE USE

Items Supplied

Please check that the article is complete as specified in the scope of delivery. If parts are missing, please contact our service center or the sales outlet where you made your purchase at the latest within 5 working days after purchasing the product and upon presentation of a valid bill of purchase. Also, refer to the warranty table in the service information at the end of the operating instructions.

- Open the packaging and take out the equipment with care.
- Remove the packaging material and any packaging and/or transportation braces (if available).
- Check to see if all items are supplied.
- Inspect the equipment and accessories for transport damage.
- If possible, please keep the packaging until the end of the guarantee period.

Danger!

The equipment and packaging material are not toys. Do not let children play with plastic bags, foils or small parts. There is a danger of swallowing or suffocating!

Proper Use

The cordless crosscut saw is designed for crosscutting wood and wood-type materials which are appropriate for the machine's size. The saw is not designed for cutting firewood.

The equipment is to be used only for its prescribed purpose. Any other use is deemed to be a case of misuse. The user / operator and not the manufacturer will be liable for any damage or injuries of any kind caused as a result of this.

Please note that our equipment has not been designed for use in commercial, trade or industrial applications. Our warranty will be voided if the machine is used in commercial, trade or industrial businesses or for equivalent purposes.

Caution! Residual risks

Even if you use this electric power tool in accordance with instructions, certain residual risks cannot be ruled out. The following hazards may arise in connection with the equipment's construction and layout:

1. Lung damage if no suitable protective dust mask is used.
2. Damage to hearing if no suitable ear protection is used.
3. Health damage caused by hand-arm vibrations if the equipment is used over a prolonged period or is not properly guided and maintained.

2. FITTING THE BATTERY & CLAMP

Inserting & Removing the Battery

- 1 Slide the battery into the seating above the saw handle until it clicks into place.

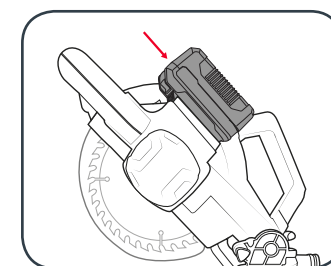

- 2 To remove, press and hold the battery release tab and then slide out.

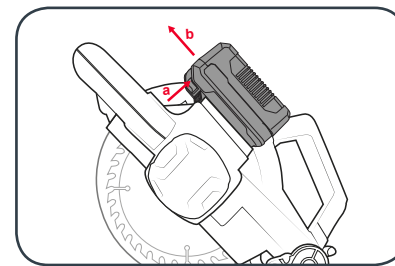

Attaching / Adjusting the Material Clamp

- 1 Loosen the clamp locking knobs and insert the shaft into the hole.
Note: The clamp can be mounted on either side of the blade.

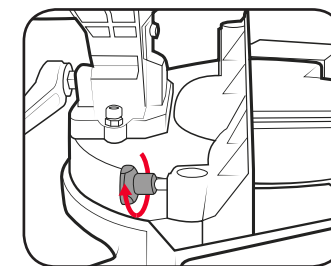

- 2 Adjust the material clamp into the desired location and tighten all locking knobs.

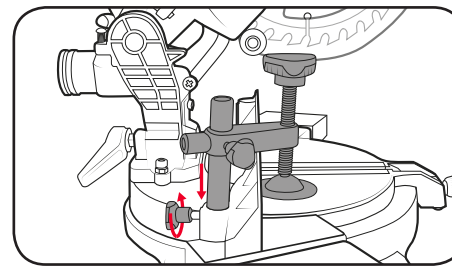

- 3 The large screw can be lowered onto the timber workpiece in order to secure the workpiece while performing a cut.

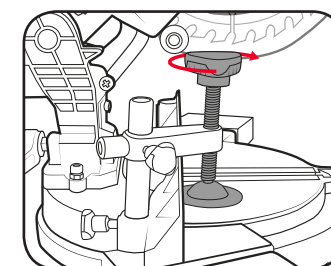

Note: When performing bevel cuts, the work clamp must be on the opposite side of the bevel (otherwise it will interfere with the cutting action).

3. EXTENSION SUPPORTS

WARNING! ENSURE THE TOOL IS SWITCHED OFF AND THE BATTERY IS REMOVED BEFORE PERFORMING ANY OF THE FOLLOWING TASKS.

Adjusting the Extension Supports

The extension supports can be extended outwards allowing additional support when cutting longer workpieces.

- 1 Press the support locking lever underneath the support arm to allow it to slide.

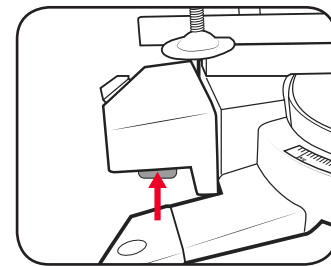

- 2 Slide the extension support to the desired location and then release the locking lever to secure in position.

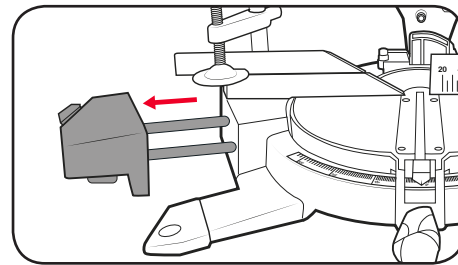

Using the Material Stops

The extension supports allow feature a material stop that can be raised in order to contact the end of the workpiece. This feature is used to quickly position material enabling you to cut multiple pieces at the same length.

- 1 Raise the material stop upwards, then adjust the extension support to the desired distance away from the blade.

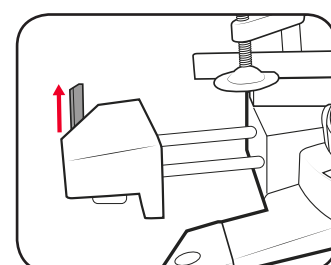

- 2 Once the material stop is set, you can place the workpiece onto the table and slide up to the stop. Secure the material and then complete the cut.

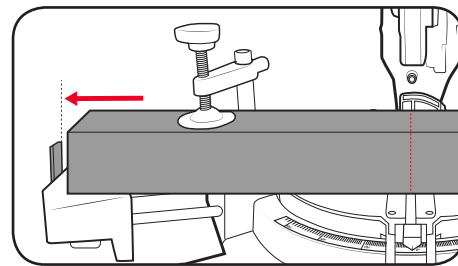

4. ADJUSTMENTS

Bevel Adjustment

- 1 Loosen bevel locking lever at the rear of the saw.

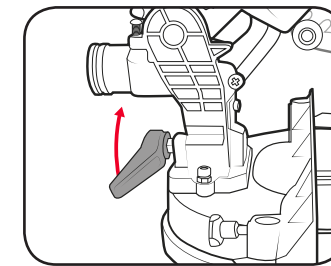

- 2 Tilt the head using the bevel scale as a reference.

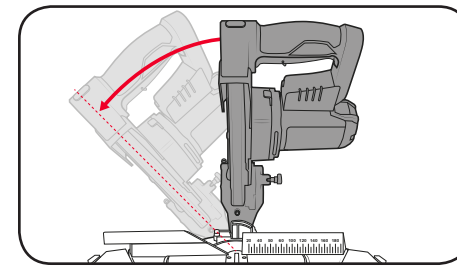

- 3 Tighten the bevel locking lever to secure at the desired bevel angle.

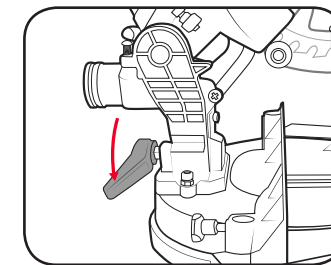

WARNING! ENSURE THE BEVEL LOCK IS TIGHT BEFORE MAKING A CUT. FAILURE TO DO SO MAY RESULT IN THE CUTTING HEAD MOVING DURING OPERATION AND CAUSE SERIOUS PERSONAL INJURY.

Mitre Adjustment

- 1 Loosen the mitre locking knob at the front of the saw.

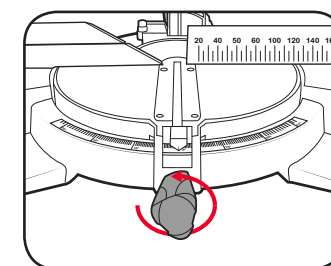

- 2 Rotate the mitre table to the desired mitre angle and then lock in position using the mitre locking knob.

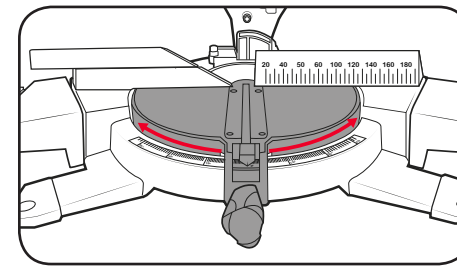

Note: The mitre table features positive click stops at 0°, 5°, 10°, 15°, 22.5°, 30°, 35°, 40° and 45° for quick setting of common mitre angles.

Fence Adjustment

- 1 Make sure that no part of the tool contacts the upper fence when bevel or compound mitre cutting.

Note: Always make a dry run with the saw turned off and check clearance. Tighten securely before making a cut.

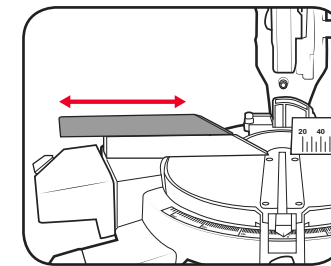

Depth Adjustment (Trenching)

Trenching refers to restricting the depth of cut and permits a "trench" to be cut in the workpiece.

- 1 Ensure the cutting head is raised, and then loosen the depth locking nut.

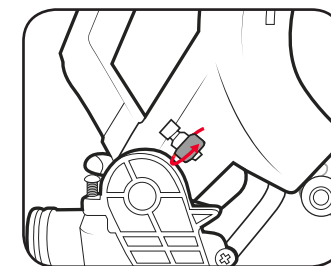

- 2 Using a hex key, adjust the depth adjustment screw so that the cutting head stops at the desired height when lowered.

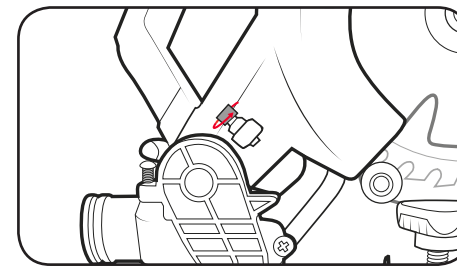

- 3 Once the desired setting is achieved, tighten the depth locking nut.

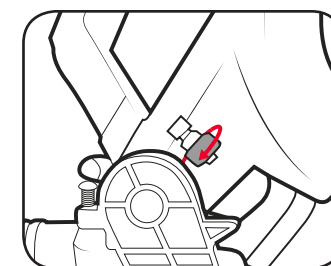

5. CONTROLS

Turning On the Worklight or Laser Line

To switch the worklight on, press the worklight switch up into the on position.

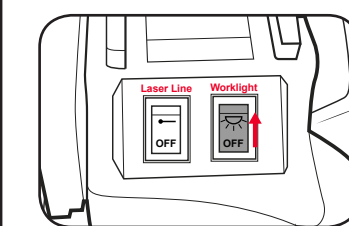

To switch the laser line on, press the laser line switch up into the on position.

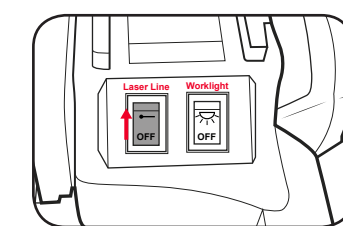

WARNING! DO NOT STARE DIRECTLY AT THE LASER BEAM OR WORKLIGHT.

Head Locking Pin

- 1 To unlock the saw head, press down slightly on the handle and then pull and rotate the head locking pin 90 degrees.
- 2 To lock the head down, press the head down and the pull and rotate the head locking pin 90 degrees.

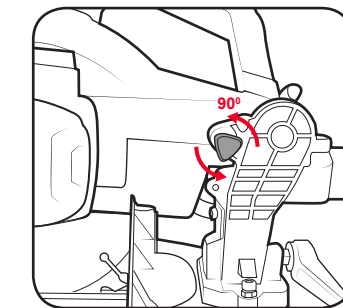

Starting the Mitre Saw

- 1 Unlock the trigger by pressing the lever on the trigger sideways. Then unlock the handle motion by pressing the handle lock button at the front of the handle.
- 2 Squeeze the on/off trigger to start the saw.

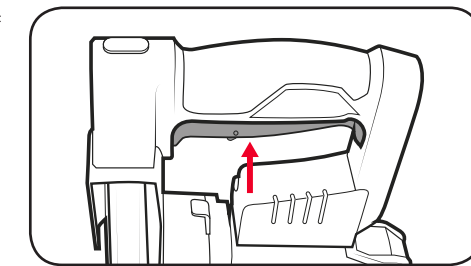
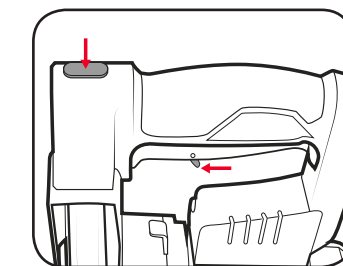

Note: Allow the saw to reach full speed before beginning a cut.

OPERATION

WARNING! DO NOT USE THE MITRE SAW TO CUT METAL OR MASONRY.

Straight Cutting

A straight cut is made by cutting the grain of the workpiece. A 90° straight cut is made with the mitre scale set in the 0°.

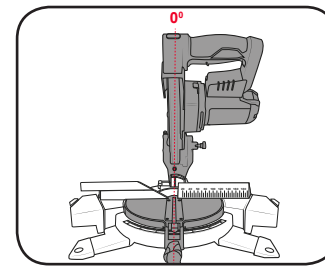
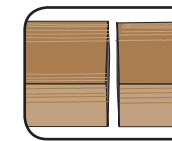

Mitre Cuts

Mitre cuts are made with the mitre scale set at an angle other than 0°.

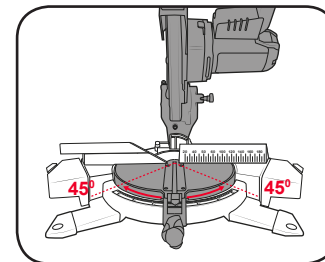
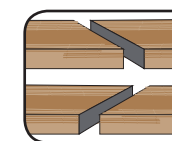

Bevel Cutting

A bevel cut is made by cutting across the grain of the workpiece with the blade angled to the mitre table.

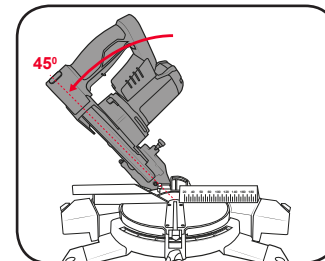
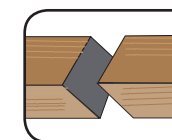

Compound Mitre Cuts

A compound mitre cut involves using a mitre angle and a bevel angle at the same time.

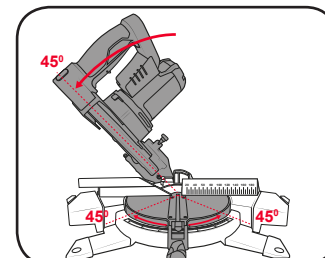
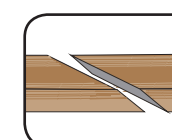

CAUTION! FOR ALL TYPES OF CUTS ENSURE THE SAW IS LOCKED INTO POSITION.

5 YEAR
REPLACEMENT WARRANTY