

ozito

WET & DRY VACUUM

1250W 20L

INSTRUCTION MANUAL

SPECIFICATIONS

Mains Voltage:	230 – 240V ~ 50Hz
Input Power:	1250W
Max. Suction Power:	180mbar
Air Flow:	68L/s
Tank Capacity:	20L
Power Outlet Max.:	1150W
Psum:	2400W
IP Rating:	IP24
Product weight:	4.7kg

ozito.com.au

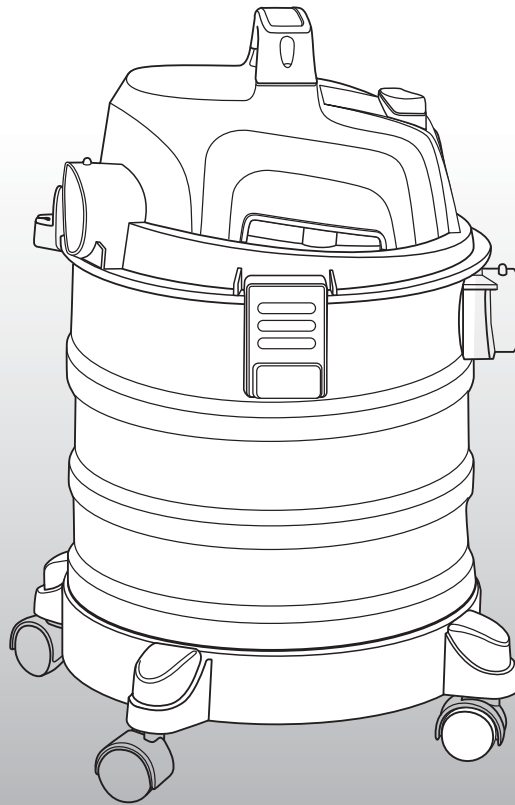

STANDARD EQUIPMENT



20L Wet & Dry Vacuum

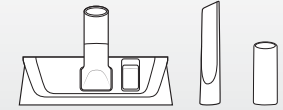

Floor Tool, Crevice Tool & Adaptor

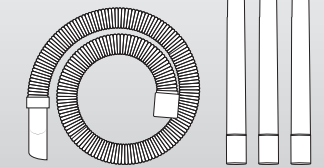

Hose & Premium Extension Tubes

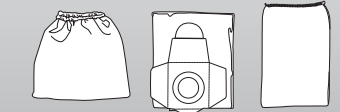

Filter Bag, Dust Bag & Foam Filter



Castor Wheels, Handle Screws

3 YEAR REPLACEMENT WARRANTY

VWD-1220PT

WARRANTY

IN ORDER TO MAKE A CLAIM UNDER THIS WARRANTY YOU MUST RETURN THE PRODUCT TO YOUR NEAREST BUNNINGS WAREHOUSE WITH YOUR BUNNINGS REGISTER RECEIPT. PRIOR TO RETURNING YOUR PRODUCT FOR WARRANTY PLEASE TELEPHONE OUR CUSTOMER SERVICE HELPLINE:

Australia 1800 069 486

New Zealand 0508 069 486

TO ENSURE A SPEEDY RESPONSE PLEASE HAVE THE MODEL NUMBER AND DATE OF PURCHASE AVAILABLE. A CUSTOMER SERVICE REPRESENTATIVE WILL TAKE YOUR CALL AND ANSWER ANY QUESTIONS YOU MAY HAVE RELATING TO THE WARRANTY POLICY OR PROCEDURE.

The benefits provided under this warranty are in addition to other rights and remedies which are available to you at law.

Our goods come with guarantees that cannot be excluded at law. You are entitled to a replacement or refund for a major failure and for compensation for any other reasonably foreseeable loss or damage. You are also entitled to have the goods repaired or replaced if the goods fail to be of acceptable quality and the failure does not amount to a major failure.

Generally you will be responsible for all costs associated with a claim under this warranty, however, where you have suffered any additional direct loss as a result of a defective product you may be able to claim such expenses by contacting our customer service helpline above.

3 YEAR REPLACEMENT WARRANTY

Your product is guaranteed for a period of **36 months from the original date of purchase**. If a product is defective it will be replaced in accordance with the terms of this warranty. Warranty excludes consumable parts, for example: Filters and dust bag.

WARNING

The following actions will result in the warranty being void.

- If the tool has been operated on a supply voltage other than that specified on the tool.
- If the tool shows signs of damage or defects caused by or resulting from abuse, accidents or alterations.
- Failure to perform maintenance as set out within the instruction manual.
- If the tool is disassembled or tampered with in any way.
- Professional, industrial or high frequency use.

KNOW YOUR PRODUCT

WET & DRY VACUUM

- | | |
|---------------------------------|--------------------------|
| 1. On/Off/Power Take Off Switch | 8. Power Take-Off Socket |
| 2. Carry Handle | 9. Vacuum Inlet |
| 3. Accessory Mount | 10. Tank |
| 4. Motor | 11. Motor Securing Clips |
| 5. Filter Cage | 12. Castors |
| 6. Safety Float | 13. Cable Hook |
| 7. Blow Outlet | |

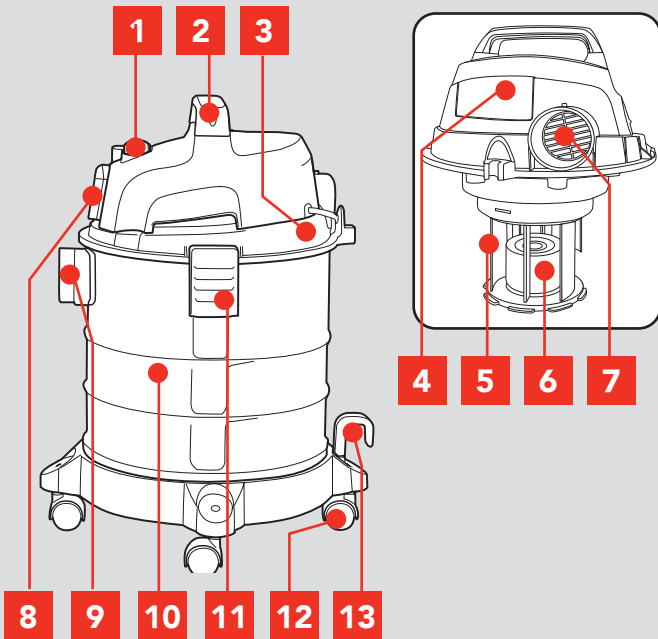

ACCESSORIES

- | | |
|-----------------------------|------------------|
| 14. Hose | 18. Floor Tool |
| 15. Premium Extension Tubes | 19. Crevice Tool |
| 16. Filter Bag | 20. Dust Bag |
| 17. Adaptor | 21. Foam Filter |

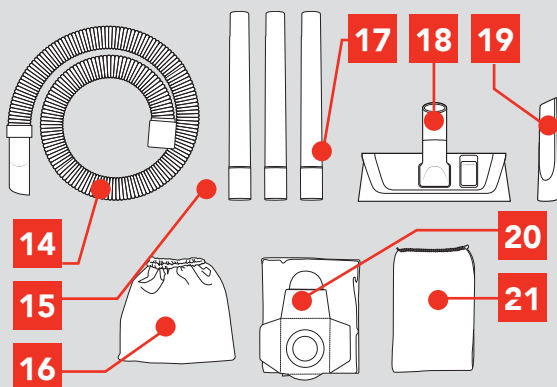

ONLINE MANUAL

Scan this QR Code with your mobile device to take you to the online manual.



SETUP & PREPARATION

1. ASSEMBLY

WARNING! ENSURE THE TOOL IS TURNED OFF AND DISCONNECTED FROM THE POWER SUPPLY BEFORE PERFORMING ANY OF THE FOLLOWING OPERATIONS.

Assembling the Castors

1. Turn the container upside down.

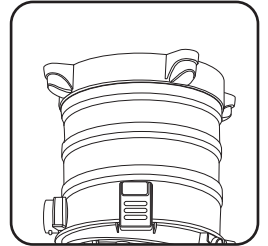

2. Insert the castor assemblies into the base of the tank. Use firm hand pressure.

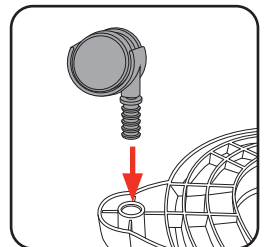

Fitting the Motor

1. When fitting the motor to the tank, position it so that the motor securing clips on the tank align with the fastening points on the motor.

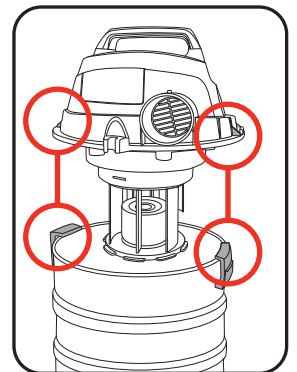

2. Fasten the motor securing clips to the motor, making sure that they lock into place correctly.

3. To remove the motor, open the motor securing clip and lift the motor out of the tank.

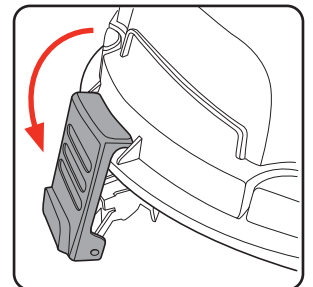

3 YEAR REPLACEMENT WARRANTY

Fitting the Handle

1. Align the holes on either side of the handle with the holes in the top side of the motor.

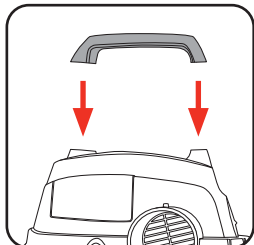

2. Insert two screws (supplied) into the handle and tighten with a screwdriver (not supplied).

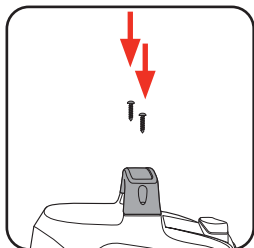

Mounting the Cable Hook

1. Press the cable hook for the cable store into the mount on the base of the unit.

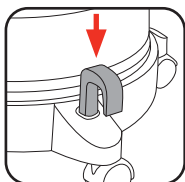

2. After use, the power cable can be conveniently wound onto the cable hooks.

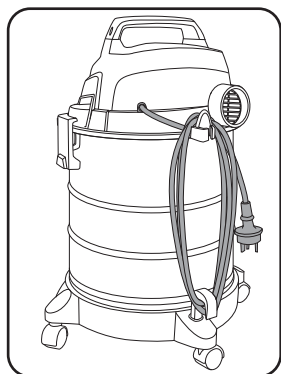

Fitting the Dust Bag

1. For vacuuming fine, dry dirt, it is recommended that you fit the dust bag. The dust bag is suitable for dry vacuuming only. Using the dust bag makes it easier to dispose of the dust that has been collected.

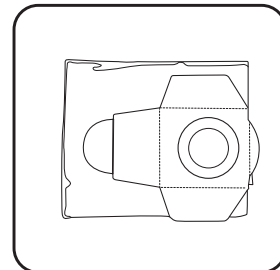

2. To attach, slip the dust bag over the vacuum inlet.

NOTE: Do not use the **dust bag** when vacuuming liquid.

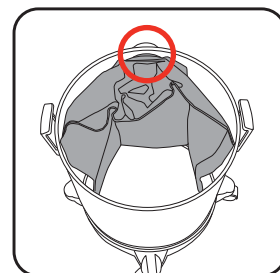

2. FITTING THE FILTER



WARNING! NEVER USE THE WET AND DRY VACUUM CLEANER WITHOUT A FILTER. ALWAYS ENSURE THAT THE FILTERS ARE PERFECTLY SECURE!

Vacuuming Liquid - Foam Filter

For wet-vacuuming, slip the supplied foam filter over the filter basket.

NOTE: Do not use the **filter bag and/or dust bag** when vacuuming liquid

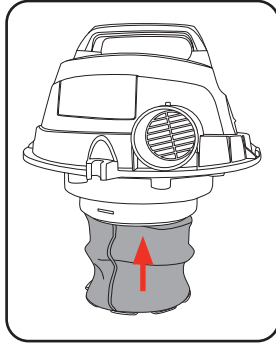

Vacuuming Dry Matter - Filter Bag

For dry vacuum cleaning always use the filter bag. Mount the filter bag, so that no air is sucked through the filter cage without being filtered.

NOTE: Do not use the **foam filter** when vacuuming dry matter.

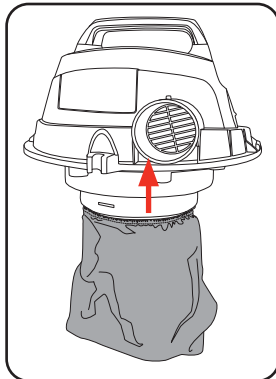

3. FITTING HOSES & NOZZLES

Connect the suction hose to the corresponding connector on the wet and dry vacuum, depending on the application required:

Vacuuming

Connect the suction hose to the vacuum inlet.

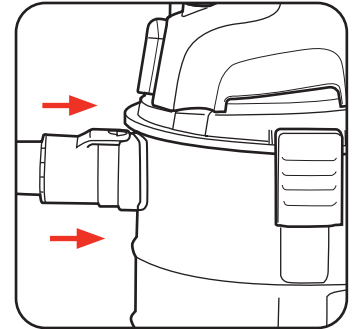

Blowing

Connect the suction hose to the blow outlet.

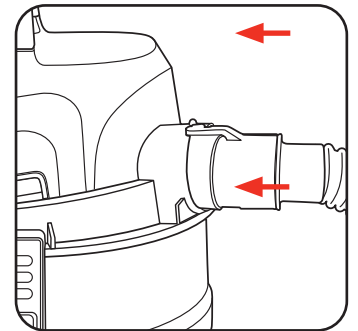

Extension Tube and Adaptor

1. The suction hose can be extended by attaching one or more sections of the 3 part extension tubes.

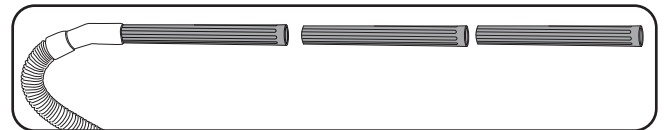

2. The adaptor must be inserted between the extension tube and whichever of the nozzles is required.

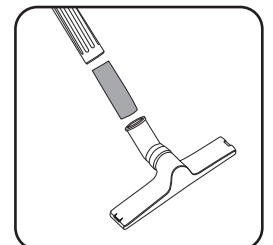

OPERATION

4. CONTROLS

Suction Tools

Floor Tool

The floor tool is for vacuuming solids and liquids over medium to large areas.

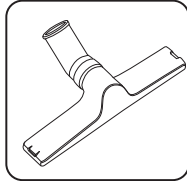

Crevice Tool

The crevice tool is designed for cleaning crevices and edges.

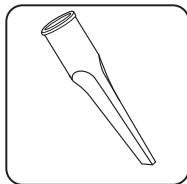

WARNING! TO REDUCE THE RISK OF ELECTRICAL SHOCK, A RESIDUAL CURRENT DEVICE (RATED 30mA OR LESS) SHOULD BE USED.



WARNING! THE WET & DRY VACUUM IS NOT SUITABLE FOR THE VACUUMING OF COMBUSTIBLE LIQUIDS.

On/Off/Auto Switch

Switch position 0: OFF

Switch position I: Normal operation

Switch position AUTO: Power Take Off Mode

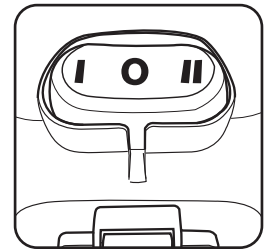

WARNING! SWITCH OFF THE EQUIPMENT IF LIQUID OR FOAM IS EMITTED WITH THE EXHAUST AIR WHEN WET VACUUM CLEANING.



WARNING! WHEN WET VACUUMING, THE SAFETY FLOAT STOPS THE VACUUM SUCTION AUTOMATICALLY WHEN THE MAXIMUM CAPACITY IS REACHED. TURN OFF THE VACUUM & EMPTY THE TANK BEFORE CONTINUING TO VACUUM.

5. POWER TAKE OFF FUNCTION

Power Take Off Mode (1150W max.)

1. Connect the power cable on your electric tool to the Power Take Off socket and connect the suction hose to the extractor connector on your power tool. Check that the connections are secure and airtight.

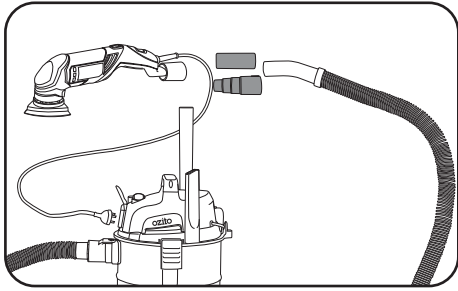

2. Set the switch on the wet and dry vacuum cleaner to the Auto: Power Take Off mode. The moment you switch on the power tool, the wet and dry vacuum cleaner switches on as well. When you switch off the power tool, the wet and dry vacuum cleaner switches off as well after a preset delay.

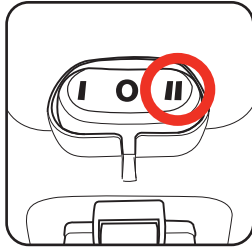

Thermal Overload Protection

The power take off outlet is equipped with an automatic thermal overload protector. This feature is designed to prevent permanent damage from occurring to the unit when it overheats during use.



WARNING! DO NOT ATTEMPT TO TURN ON THE CONNECTED POWER TOOL AGAIN IF IT SHUTS OFF AT ANY TIME DURING USE. THE THERMAL OVERLOAD PROTECTOR HAS KICKED IN.

1. Turn the on/off switch to the off position for both the vacuum and connected power tool.
2. Disconnect the power tool from the power take off outlet and check the rating label of the power tool.



WARNING! THE POWER TAKE OFF OUTLET HAS A MAXIMUM LIMIT OF 1150W. TOOLS WITH A HIGHER POWER RATING SHOULD NOT BE CONNECTED TO THIS OUTLET.

3. Allow the unit to cool down completely. Approximately 10 minutes (depending on ambient conditions). The thermal overload protector will automatically reset when the tool temperature has dropped within safe operating temperatures.

MAINTENANCE



WARNING! BEFORE CLEANING YOUR VACUUM CLEANER OR CARRYING OUT ANY MAINTENANCE PROCEDURE, MAKE SURE THAT IT IS DISCONNECTED FROM THE POWER SUPPLY TO PREVENT ACCIDENTAL STARTING.

Cleaning

Keep all safety devices, air vents and the motor housing free of dirt and dust as far as possible.

We recommend that you clean the equipment immediately after you use it.

Cleaning the motor housing

Clean the appliance regularly with a damp cloth. Do not use cleaning agents or solvents; these may be aggressive to the plastic parts in the appliance.

Cleaning the tank

The tank can be cleaned with a damp cloth and some soft soap or under running water, depending on the amount of dirt.

Cleaning the foam filter

Clean the foam filter with a little soft soap under running water and allow it to air-dry.

Storing

Ensure the Wet & Dry Vac has been fully emptied of any dry matter or liquid before it is stored.

Wrap the power cable around the cable hooks.

Keep all the accessories with the unit to avoid losing them.

Keep in a dry place out of reach of children.

DESCRIPTION OF SYMBOLS

V	Volts	Hz	Hertz
~	Alternating Current	W	Watts
L/s	Litres per second	L	Litres
IPX4	Ingress protection from water	mbar	Pressure rating (millibar)
	Regulatory Compliance Mark (RCM)		Warning
	Read Instruction Manual		

CARING FOR THE ENVIRONMENT



Power tools that are no longer usable should not be disposed of with household waste but in an environmentally friendly way. Please recycle where facilities exist. Check with your local council authority for recycling advice.



Recycling packaging reduces the need for landfill and raw materials. Reuse of recycled material decreases pollution in the environment. Please recycle packaging where facilities exist. Check with your local council authority for recycling advice.

SPARE PARTS

Spare parts can be ordered from the Special Orders Desk at your local Bunnings Warehouse.

For further information, or any parts not listed here, visit www.ozito.com.au or contact Ozito Customer Service:

Australia 1800 069 486

New Zealand 0508 069 486

E-mail: enquiries@ozito.com.au

ELECTRICAL SAFETY

 **WARNING!** When using mains-powered tools, basic safety precautions, including the following, should always be followed to reduce risk of fire, electric shock, personal injury and material damage.

Read the whole manual carefully and make sure you know how to switch the tool off in an emergency, before operating the tool.
Save these instructions and other documents supplied with this tool for future reference.

The electric motor has been designed for 230V and 240V only. Always check that the power supply corresponds to the voltage on the rating plate.

Note: The supply of 230V and 240V on Ozito tools are interchangeable for Australia and New Zealand.

Note: The power outlet used for the vacuum must be protected by a 30mA residual current device or earth leakage circuit breaker.

If the replacement of the supply cord is necessary, this has to be done by the manufacturer or his agent in order to avoid a hazard.

Using an Extension Lead

Always use an approved extension lead suitable for the power input of this tool. Before use, inspect the extension lead for signs of damage, wear and ageing. Replace the extension lead if damaged or defective. When using an extension lead on a reel, always unwind the lead completely. Use of an extension lead not suitable for the power input of the tool or which is damaged or defective may result in a risk of fire and electric shock.

GENERAL POWER TOOL SAFETY WARNINGS

 **WARNING!** Read all safety warnings and all instructions. Failure to follow the warnings and instructions may result in electric shock, fire and/or serious injury.

Save all warnings and instructions for future reference. The term "power tool" in the warnings refers to your mains-operated (corded) power tool or battery-operated (cordless) power tool.

1. Work area safety

- Keep work area clean and well lit.** Cluttered or dark areas invite accidents.
- Do not operate power tools in explosive atmospheres, such as in the presence of flammable liquids, gases or dust.** Power tools create sparks which may ignite the dust or fumes.
- Keep children and bystanders away while operating a power tool.** Distractions can cause you to lose control.

2. Electrical safety

- Power tool plugs must match the outlet. Never modify the plug in any way. Do not use any adapter plugs with earthed (grounded) power tools.** Unmodified plugs and matching outlets will reduce risk of electric shock.
- Avoid body contact with earthed or grounded surfaces, such as pipes, radiators, ranges and refrigerators.** There is an increased risk of electric shock if your body is earthed or grounded.
- Do not expose power tools to rain or wet conditions.** Water entering a power tool will increase the risk of electric shock.
- Do not abuse the cord. Never use the cord for carrying, pulling or unplugging the power tool. Keep cord away from heat, oil, sharp edges or moving parts.** Damaged or entangled cords increase the risk of electric shock.
- When operating a power tool outdoors, use an extension cord suitable for outdoor use.** Use of a cord suitable for outdoor use reduces the risk of electric shock.
- If operating a power tool in a damp location is unavoidable, use a residual current device (RCD) protected supply with a rated residual current of 30mA or less.** Use of an RCD reduces the risk of electric shock.

3. Personal safety

- Stay alert, watch what you are doing and use common sense when operating a power tool. Do not use a power tool while you are tired or under the influence of drugs, alcohol or medication.** A moment of inattention while operating power tools may result in serious personal injury.
- Use personal protective equipment. Always wear eye protection.** Protective equipment such as dust mask, non-skid safety shoes, hard hat, or hearing protection used for appropriate conditions will reduce personal injuries.
- Prevent unintentional starting. Ensure the switch is in the off-position before connecting to power source and/or battery pack, picking up or carrying the tool.** Carrying power tools with your finger on the switch or energising power tools that have the switch on invites accidents.

- Remove any adjusting key or wrench before turning the power tool on.** A wrench or a key left attached to a rotating part of the power tool may result in personal injury.
 - Do not overreach. Keep proper footing and balance at all times.** This enables better control of the power tool in unexpected situations.
 - Dress properly. Do not wear loose clothing or jewellery. Keep your hair, clothing and gloves away from moving parts.** Loose clothes, jewellery or long hair can be caught in moving parts.
 - If devices are provided for the connection of dust extraction and collection facilities, ensure these are connected and properly used.** Use of dust collection can reduce dust-related hazards.
 - Do not let familiarity gained from frequent use of tools allow you to become complacent and ignore tool safety principles.** A careless action can cause severe injury within a fraction of a second.
- ## 4. Power tool use and care
- Do not force the power tool. Use the correct power tool for your application.** The correct power tool will do the job better and safer at the rate for which it was designed.
 - Do not use the power tool if the switch does not turn it on and off.** Any power tool that cannot be controlled with the switch is dangerous and must be repaired.
 - Disconnect the plug from the power source and/or the battery pack from the power tool before making any adjustments, changing accessories, or storing power tools.** Such preventive safety measures reduce the risk of starting the power tool accidentally.
 - Store idle power tools out of the reach of children and do not allow persons unfamiliar with the power tool or these instructions to operate the power tool.** Power tools are dangerous in the hands of untrained users.
 - Maintain power tools.** Check for misalignment or binding of moving parts, breakage of parts and any other condition that may affect the power tool's operation. If damaged, have the power tool repaired before use. Many accidents are caused by poorly maintained power tools.
 - Keep cutting tools sharp and clean.** Properly maintained cutting tools with sharp cutting edges are less likely to bind and are easier to control.
 - Use the power tool, accessories and tool bits etc. in accordance with these instructions, taking into account the working conditions and the work to be performed.** Use of the power tool for operations different from those intended could result in a hazardous situation.
- ## 5. Service
- Have your power tool serviced by a qualified repair person using only identical replacement parts.** This will ensure that the safety of the power tool is maintained.

WET & DRY VACUUM SAFETY WARNINGS

The appliance is not to be used by persons (including children) with reduced physical, sensory or mental capabilities, or lack of experience and knowledge, unless they have been given supervision or instruction.

Young children should be supervised to ensure that they do not play with the appliance.

 **WARNING!** When using the equipment, a few safety precautions must be observed to avoid injuries and damage. Please read the complete operating manual with due care. Keep this manual in a safe place so that the information is available at all times. If you give the equipment to any other person, give them these operating instructions as well.

We cannot accept any liability for damage or accidents which arise due to a failure to follow these instructions and the safety information.

- Do not leave appliance unattended when plugged in. Unplug from outlet when not in use and before servicing and cleaning.
- To avoid electric shock, do not expose to rain. Store indoors.
- Never use in the presence of explosive liquids, vapours or explosive dust – such as coal or grain.
- Never pick up asbestos or asbestos dust.
- Wood dust and chips in a confined area can give rise to fire or an explosion. Guard against possible ignition sources.
- Do not pick up anything that is burning or smouldering – such as metal grinding dust, cigarette ends, hot coals, matches or similar.
- The appliance is not intended for use by young children or infirm persons without supervision. Young children should be supervised to ensure they do not play with the appliance.
- Use only manufacturer's recommended attachments and consumable.

- Never modify the cleaner in any way - this is dangerous and will invalidate the warranty.
- Do not use cleaner without the filter in place.
- If motor sound becomes higher pitched always check for the following:
 - Blocked hose or accessory.
 - Blocked filter.
 - Full container.
- Never try to move the cleaner by pulling with the mains lead.
- Always check that the filter is clear and not blocked. Keep all openings clear of any blockages.
- When lifting the unit, always lift it with the handle or under rim of bucket. Beware of excess weight.
- Always switch the unit off before changing attachments or connecting different power tools.
- Always disconnect equipment from the appliance when it is not in use.
- If the cordset is damaged have it repaired by an authorised service centre.
- The wet and dry vacuum cleaner is designed for wet and dry vacuuming using the appropriate filter. The appliance is not suitable for the vacuuming of combustible, explosive or harmful substances.**
- The equipment is to be used only for its prescribed purpose. Any other use is deemed to be a case of misuse. The user / operator and not the manufacturer will be liable for any damage or injuries of any kind caused as a result of this.**