

Circular Hand Saw YPL 1200

Art.-No.: **43.308.51**

Bar code: **4006825505948**

Sales unit: **4 pcs**

Handy and powerful circular hand saw just right for hard continuous working. The YPL 1200 is the ideal power tool for precise along- and cross-cuts. The housing is made of impact resistant plastics. The saw blade – protection housing is made of aluminium.

Features:

- Toolless saw table adjustment (1)
- Carbide tipped saw blade (2)
- Parallel guide (3)
- Saw blade protection housing made of aluminium (4)
- Dust exhaust adapter (5)
- Toolless cutting depth adjustment

Technical data:

- | | |
|-----------------------------|---------------------------------|
| - Mains: | 230 V ~ 50 Hz |
| - Power: | 1,200 watts |
| - Idle speed max: | 4,500 rpm |
| - Cutting depth at 90°: | 55 mm |
| - Cutting depth at 45°: | 39 mm |
| - Carbide tipped saw blade: | Ø 160 x Ø 20 x 2.5 mm, 18 teeth |
| - Weight: | 4.3 kg |
| - Packing dimension: | 320 x 245 x 228 mm |

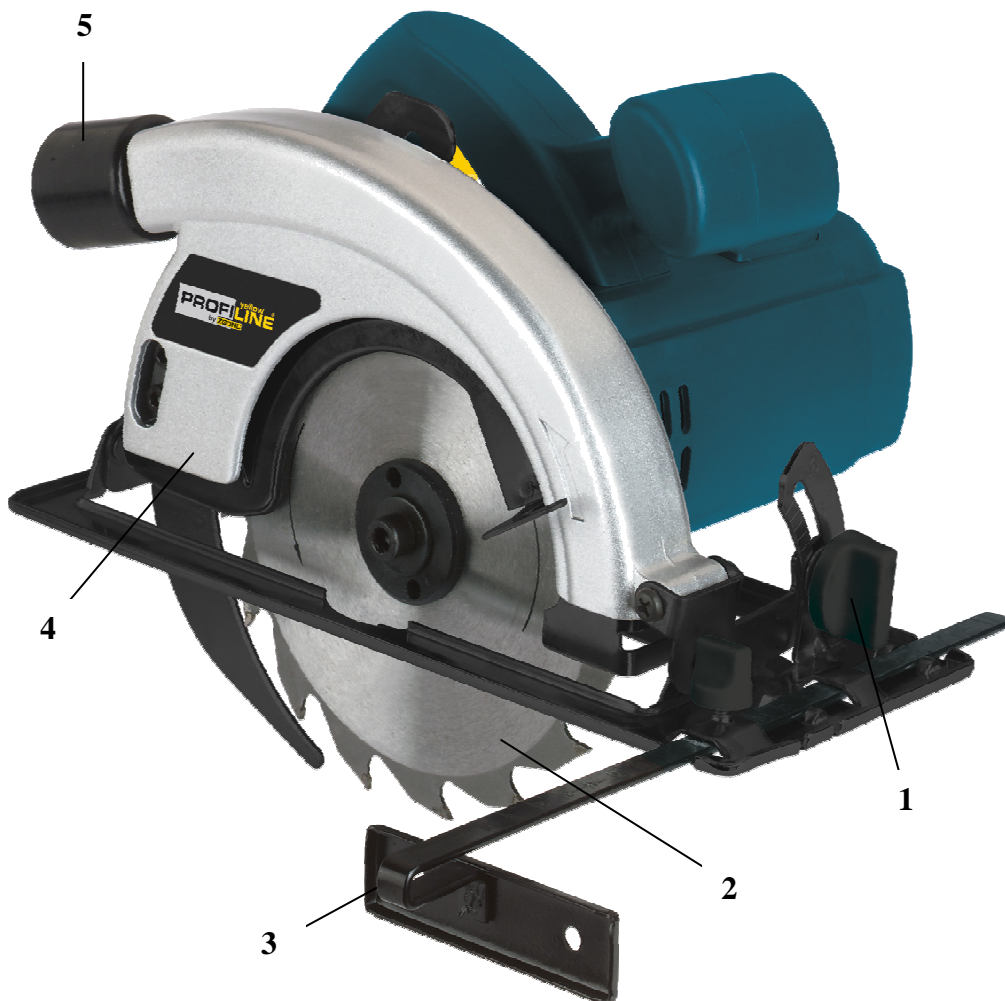

As special accessory available:

Carbide tipped saw blade **Art.-No.: 45.020.30**
160 x 20 x 2.8 mm; 18 teeth **Bar code: 4006825453072**