

PARKSIDE

PSZ 250 A1



GB IE

CABLE HOIST

Operation and Safety Notes
Original operating instructions

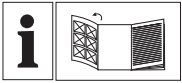

GB IE

Before reading, unfold the page containing the illustrations and familiarise yourself with all functions of the device.

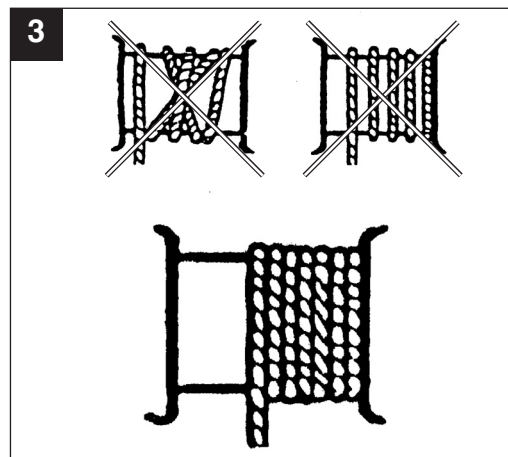
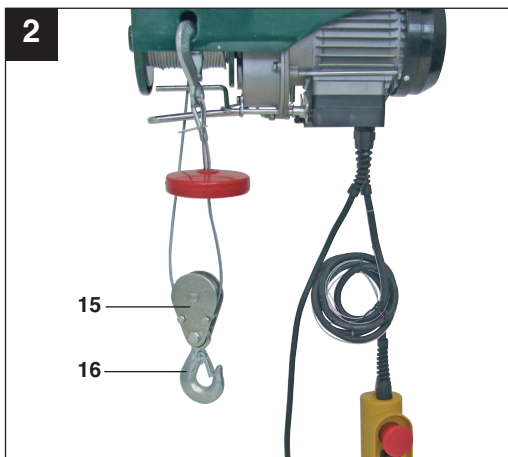
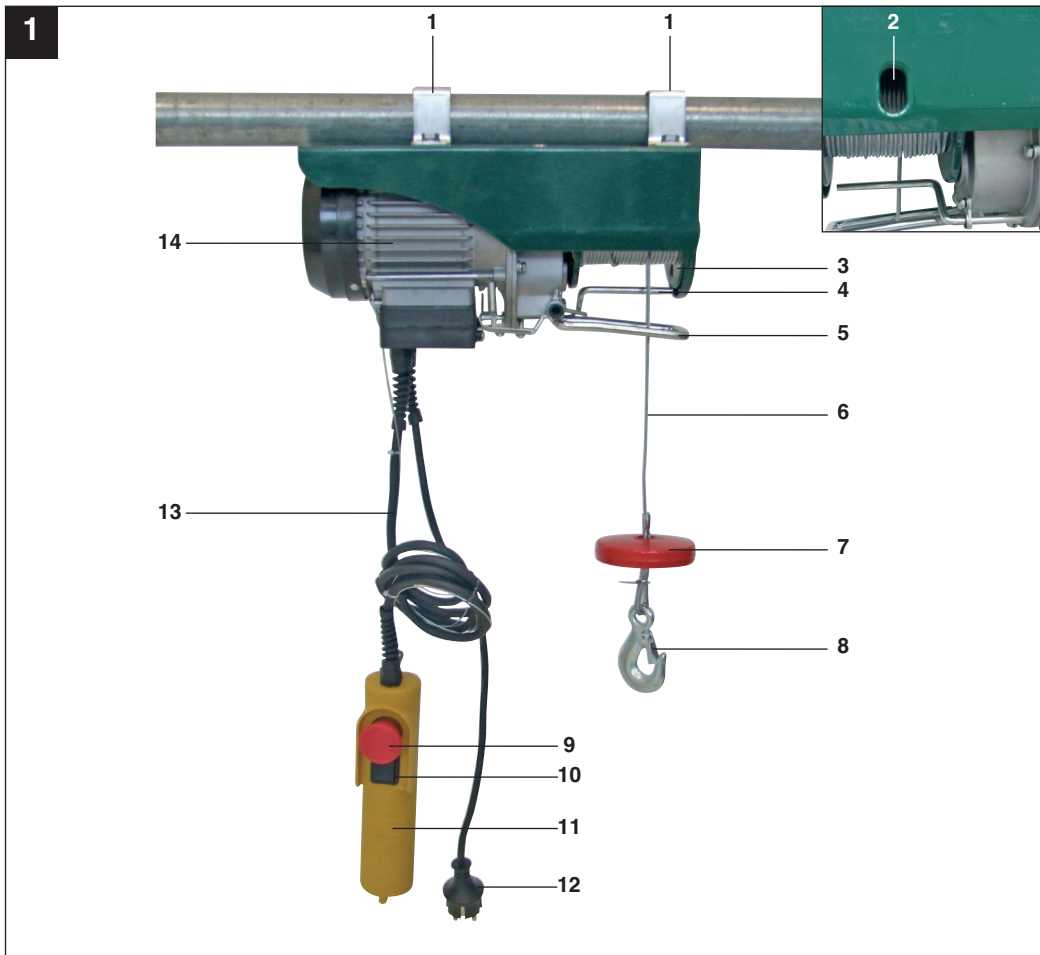

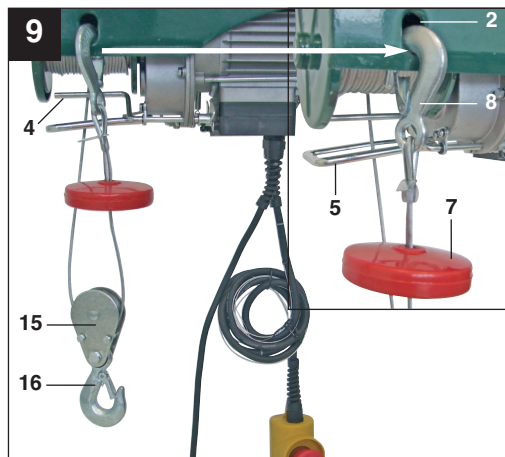
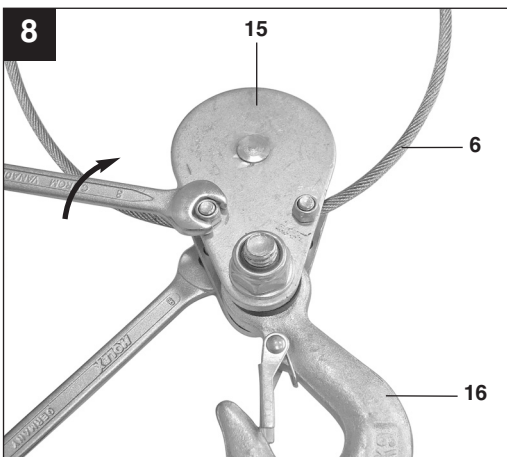
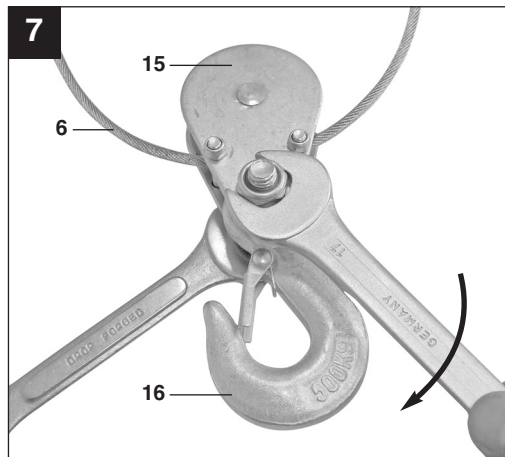
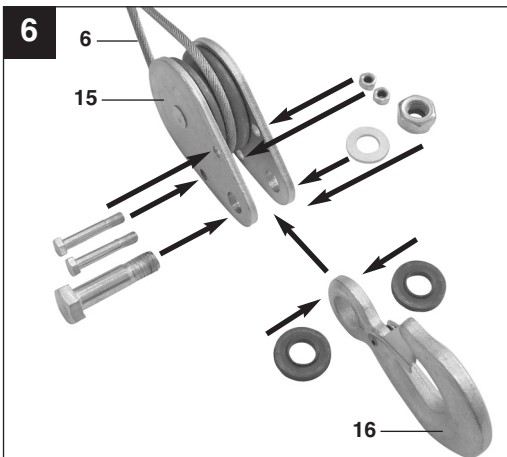
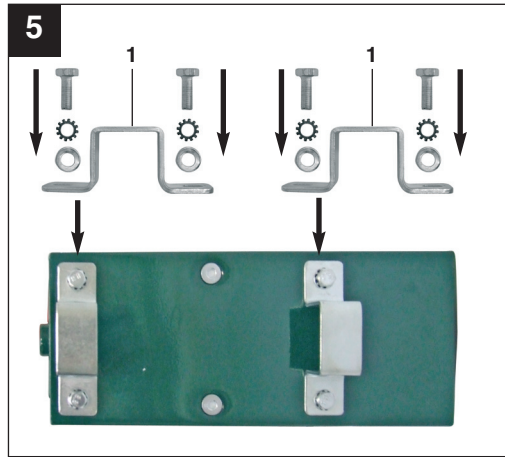
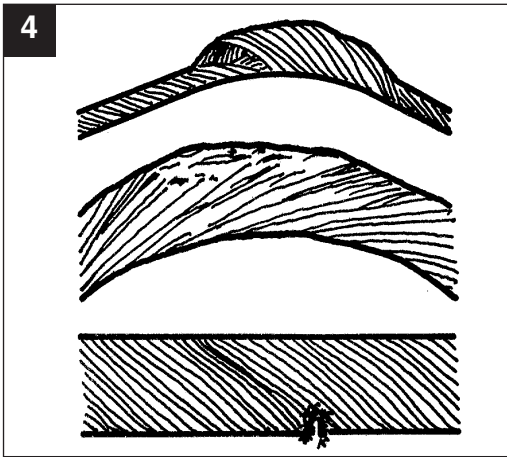

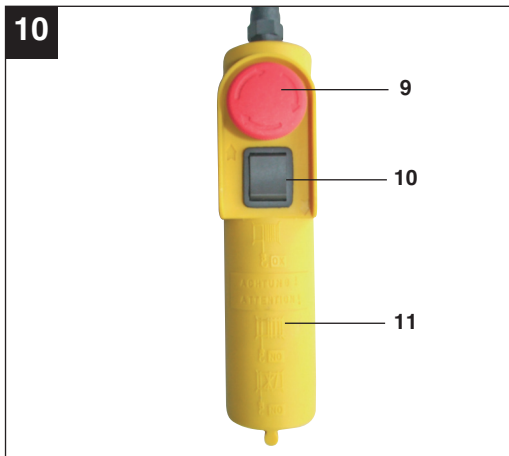



Table of contents:

Page

1. Introduction	7
2. Safety information	7
3. Layout and items supplied	7
4. Proper use	8
5. Technical data	8
6. Before starting the equipment.....	8-9
7. Operation	9-10
8. Cleaning, maintenance and ordering of spare parts	10
9. Disposal and recycling	10-11
10. Declaration of conformity	12
11. Guarantee Certificate	13

The reprinting or reproduction by any other means, in whole or in part, of documentation and papers accompanying products is permitted only with the express consent of ISC GmbH.

Technical changes subject to change

1. Introduction

⚠ Important!

When using equipment, a few safety precautions must be observed to avoid injuries and damage. Please read the complete operating manual with due care. Keep this manual in a safe place, so that the information is available at all times. If you give the equipment to any other person, give them these operating instructions as well. We accept no liability for damage or accidents which arise due to non-observance of these instructions and the safety information.

2. Safety information

⚠ CAUTION!

Read all safety regulations and instructions.

Any errors made in following the safety regulations and instructions may result in an electric shock, fire and/or serious injury.

Keep all safety regulations and instructions in a safe place for future use.

- Always check that the mains voltage is identical to the voltage quoted on the rating plate. In the event that the mains voltage is not suitable, it may cause the machine to work abnormally and thus result in personal injury.
- The power supply must be earthed and be secured by a residual current operated circuit breaker (RCCB).
- Do not attempt to lift loads that exceed the rated load.
- Use the machine only for the purpose for which it is designed. Never lift personnel using the cable hoist.
- Do not pull the power cable in order to pull out the plug. Protect the power cable from heat, oil and sharp edges.
- Never attempt to raise fixed or jammed loads.
- Pull out the plug when the cable hoist is not in use.

- Keep children and other unauthorized persons away from the machine.
- Do not pull loads sideways or from one side. Do not allow the load to swing.
- Ensure that the hook moves in the same direction as shown on the pushbutton.
- Check the cable hoist at regular intervals for signs of damage. The pushbutton must be in good condition.
- Have repair and servicing work carried out only by authorized workshops by a trained electrician. Repair work must only be carried out by a trained electrician, otherwise the machine may cause accidents.
- Do not switch the machine on and off quickly (inching mode).
- Always concentrate fully when operating the cable hoist.
- Do not stand or work under the raised load.
- It is not permitted to lift fixed or jammed loads.

3. Layout and items supplied (Fig. 1-2)

1. Fastening bar
2. Fastening hole for hook
3. Drum
4. Lever for maximum cable length
5. Automatic stop mechanism lever
6. Steel cable
7. Cut-out weight
8. Hook
9. Emergency Stop switch
10. Pushbutton
11. Remote control
12. Power cable
13. Control cable
14. Motor
15. Return roller
16. Additional hook

4. Proper use

The cable hoist is designed for lifting and lowering loads in enclosed areas commensurate with the machine's capacity.

The equipment is to be used only for its prescribed purpose. Any other use is deemed to be a case of misuse. The user / operator and not the manufacturer will be liable for any damage or injuries of any kind caused as a result of this.

Please note that our equipment has not been designed for use in commercial, trade or industrial applications. Our warranty will be voided if the machine is used in commercial, trade or industrial businesses or for equivalent purposes.

5. Technical data

Voltage (V)	230 V ~ 50 Hz
Rated current (A)	2.2
Power consumption (W)	500
Operating mode	S3 20%:10 min
Rated load (kg)	125 / 250
Lifting height (m)	11.5 / 5.7
Rated speed (m/min)	8 / 4
Diameter of steel cable (mm)	3.0
Tensile strength of the steel cable (N/mm ²)	1870
Insulation class	B
Protection class	IP24
Drive unit class	M1
Net weight (kg)	10.5

Operating mode S3 – 20% - 10 minutes: S3 = Intermittent mode without influencing the starting process. This means that the maximum operating period over a time of 10 minutes is 20% (2 minutes).

6. Before starting the equipment

- Before you connect the equipment to the mains supply make sure that the data on the rating plate are identical to the mains data.
- Always pull out the power plug before making adjustments to the equipment.
- The cable hoist is not suitable for transporting hot and/or molten materials nor is it suitable for use at low temperatures or in environments subject to intensive weathering.
- It is in mechanical group M1.
- The service life of the cable hoist is approximately 8000 cycles (excluding wearing parts). When the hoist has completed 8000 cycles, all its mechanical parts must be checked and overhauled.
- Read and absorb the operating instructions before you use the cable hoist.
- Ensure that the operator knows how the machine works and how it should be operated.
- The user must always operate the equipment as set out in the operating instructions.
- The cable hoist is not designed for continuous operation. Its mode of operation is: Intermittent mode without influencing the starting process.
- The rated capacity of the machine does not vary due to the position of the load.

6.1 Unpacking

After opening the packaging, inspect the equipment, the steel cable, the hook, the lever for maximum cable length and the automatic stop mechanism lever for signs of possible transit damage.

6.2 Assembly (Fig. 5)

The cable hoist is fitted with two fastening bars (1) with which it has to be fastened to a rectangular tube / swing arm. The dimensions of the rectangular tube / swing arm must conform with the size of the fastening bars (1) and must be capable of supporting twice the rated load. We recommend that you seek

advice from a qualified technician. All screws must be tightened correctly. A qualified technician should check the anchoring of the rectangular tube / swing arm before the machine is started.

6.3 Block and tackle function (Fig. 6 – 9)

The cable hoist is fitted with a return roller (15) and an additional hook (16). If these parts are used correctly, the cable hoist can lift twice its rated load.

Fit the return roller (15) and additional hook (16) as shown in Figure 6 – 8. The permanent hook (8) must be attached to the fastening hole (2) (Fig. 9).

The load is now raised by two steel cables, which means that the cable hoist can lift twice its rated load.

7. Operation

7.1 Starting up

- Remove the adhesive tape from the drum (3) before using the hoist for the first time.
- The value of the A-rated noise emissions at the operator's position is less than 70 dB.
- Supply voltage: 230 V ± 10%, 50 Hz ± 1%.
- The cable hoist must be operated in ambient temperatures of between 0°C and 40°C with a relative humidity of less than 85%. Height above sea level: max. 1,000 m.
- The temperature for transport and storage may be between -25°C and 55°C. The maximum temperature must not exceed 70°C.
- The user should lift the load off the ground at the slowest possible speed. The cable should be taut when the load is raised.
- The motor (14) for the cable hoist is fitted with a thermostat switch. Whilst the cable hoist is operating, the motor (14) may therefore stop. It will restart automatically when it has cooled down.
- The electric cable hoist is not fitted with a rated power limiter. You should therefore not repeat attempts to lift a load if the overload trip is limiting the hoist's

operation. In this case the load exceeds the rated capacity of the cable hoist.

- Do not leave any suspended loads unsupervised without first taking the appropriate safety precautions.
- Fit the machine with a 10 A fuse or a 10 A residual current operated circuit breaker (RCCB) to protect the circuit
- Do not use the lever (4/5) as a routine stopping device. It should only be used to stop the machine in an emergency.
- Before you start, ensure that the steel cable (6) is correctly wound around the drum (3) and that the spacing between the windings is smaller than the steel cable (Fig. 3)
- Ensure that the load is correctly secured to the hook (8) or, if you are using the block and tackle, the additional hook (16) and always maintain a safe distance from the load and the steel cable (6).

7.2 Operation (Fig. 9-10)

- Check whether the Emergency Stop switch (9) is pressed. Turn the Emergency Stop switch clockwise to release it.
- Press the pushbutton ▲ (10) to raise the load.
- Press the pushbutton ▼ (10) to lower the load.
- Automatic stop mechanism lever (5): When the maximum lifting height has been reached, the cut-out weight (7) presses the lever (5) upwards. This trips a limit switch after which the load cannot be raised any further.
- Lever for maximum cable length (4): When the load has reached its lowest possible position, a limit switch is tripped which makes it impossible to lower the load any further. This limit switch also prevents the cable hoist operating in the wrong direction (hook moving in the opposite direction to the arrow shown on the pushbutton).
- The cable hoist will stop if the Emergency Stop switch (9) is pressed.
- In an emergency, immediately press the Emergency Stop switch (9) to stop the cable hoist. The cable hoist cannot be operated if the Emergency Stop switch has

been pressed.

8. Cleaning, maintenance and ordering of spare parts

Always pull out the mains power plug before starting any cleaning work.

8.1 Cleaning

- Keep all safety devices, air vents and the motor housing free of dirt and dust as far as possible. Wipe the equipment with a clean cloth or blow it with compressed air at low pressure.
- Clean the equipment immediately after you use it.
- Clean the equipment regularly with a moist cloth and some soft soap. Do not use cleaning agents or solvents; these could attack the plastic parts of the equipment. Ensure that no water can seep into the device.

8.2 Servicing

Important. Always ensure that the machine is not connected to the mains supply before you start any servicing work.

- In the following: One cycle means one raising and lowering movement of a load. Periodic inspection means an inspection after 100 cycles.
- Test periodically that the limit switches on the cable hoist are in correct working order. (Test without a load) Conduct this test as follows: When the cable has reached the maximum height, the lever on the automatic stopping mechanism (5) will be actuated. The motor (14) must then stop. When the steel cable (6) has been unwound as far as possible, the lever for the maximum cable length (4) will be actuated. The motor (14) must then stop.
- Inspect the mains cable (12) and the control cable (13) periodically.
- The steel cable (6) and return roller (15) must be greased every 200 cycles.
- A check must be made every 30 cycles, as shown in Fig. 4, to find whether the entire

steel cable (6) is in good condition. If it is damaged, it must be replaced by a steel cable of the type specified in the technical data.

- Check every 1000 cycles whether the screws for the fastening bars (1) and return roller (15) are properly tightened.
- Check every 1000 cycles whether the hooks (8/16) and return roller (15) are in good condition.
- Check before using the cable hoist whether the Emergency Stop switch (9) and pushbuttons (10) are in perfect working order.
- Check the braking system every 1000 cycles. If the motor (14) makes any unusual noises or cannot raise the rated load, it is possible that the braking system requires an overhaul:
 - Replace damaged or worn parts and keep the service documentation relating to this in a safe place.
 - Please contact an authorized service center for any unscheduled maintenance work.

8.3 Ordering replacement parts:

Please quote the following data when ordering replacement parts:

- Type of machine
 - Article number of the machine
 - Identification number of the machine
- For our latest prices and information please go to www.isc-gmbh.info

9. Disposal and recycling

The unit is supplied in packaging to prevent its being damaged in transit. This packaging is raw material and can therefore be reused or can be returned to the raw material system. The unit and its accessories are made of various types of material, such as metal and plastic. Defective components must be disposed of as special waste. Ask your dealer or your local council.



For EU countries only

Never place any electric tools in your household refuse.

To comply with European Directive 2002/96/EC concerning old electric and electronic equipment and its implementation in national laws, old electric tools have to be separated from other waste and be disposed of in an environment-friendly fashion, e.g. by taking to a recycling depot.

Recycling alternative to returning the electrical equipment:

The owner of the electrical equipment is obligated to arrange for its proper disposal if he no longer wants to keep the equipment in his possession and does not want to return it. In this case the old equipment can be taken to a recycling depot where it is disposed of in accordance with national recycling and waste disposal laws. This does not apply to accessory parts and aids which supplement the old equipment and contain no electrical parts

GB/
IE

10. Declaration of conformity

Einhell Germany AG · Wiesenweg 22 · D-94405 Landau/Isar

**Konformitätserklärung**

- erklärt folgende Konformität gemäß EU-Richtlinie und Normen für Artikel
 explains the following conformity according to EU directives and norms for the following product
 déclare la conformité suivante selon la directive CE et les normes concernant l'article
 dichiara la seguente conformità secondo la direttiva UE e le norme per l'articolo
 verklaart de volgende overeenstemming conform EU richtlijn en normen voor het product
 declara la siguiente conformidad a tenor de la directiva y normas de la UE para el artículo
 declara a seguinte conformidade, de acordo com a directiva CE e normas para o artigo
 attesterer følgende overensstemmelse i medfør af EU-direktiv samt standarder for artiklet
 förklarar följande överensstämmelse enl. EU-direktiv och standarder för artikeln
 vakuuttaa, että tuote täyttää EU-direktiivin ja standardien vaatimukset
 töendab toote vastavust EL direktiivile ja standarditele
 vydává následující prohlášení o shodě podle směrnice EU a norem pro výrobek
 potrjuje sledečo skladnost s smernico EU in standardi za izdelke
 vydáva nasledujúce prehlásenie o zhode podľa smernice EÚ a noriem pre výrobok
 a cikkekhez az EU-irányvonal és Normák szerint a következő konformitást jelenti ki
 deklaruje zgodność wymienionego poniżej artykułu z następującymi normami na podstawie dyrektywy WE.
 декларира съответното съответствие съгласно Директива на ЕС и норми за артикул
 paskaidro šādu atbilstību ES direktīvai un standartiem
 apibūdina šj atitikamā EU reikalavimams ir prekės normoms
 declară următoarea conformitate conform directivei UE și normelor pentru articolul
 δηλώνει την ακόλουθη συμμόρφωση σύμφωνα με την Οδηγία ΕΚ και τα πρότυπα για το προϊόν
 potvrđuje sljedeću usklađenost prema smjernicama EU i normama za artikl
 potvrđuje sljedeću usklađenost prema smjernicama EU i normama za artikl
 potvrđuje sledeću usklađenost prema smernicama EÚ i normama za artikla
 следующим удостоверяется, что следующие продукты соответствуют директивам и нормам ЕС
 проголошує про зазначену нижче відповідність виробу директивам та стандартам ЄС на виріб
 ja izjavuва следната сообразност согласно EY-директивата и нормите за артикли
 Ürünü ile ilgili AB direktifleri ve normları gereğince aşağıda açıklanan uygunluğu belirtir
 erklærer følgende samsvar i henhold til EU-direktivet og standarder for artikkel
 Lýsir uppfyllingu EU-reglna og annarra staðla vöru

Seilhebezug PSZ 250 A1 (Parkside)

- | | |
|---|--|
| <input type="checkbox"/> 2009/105/EC | <input checked="" type="checkbox"/> 2006/42/EC |
| <input type="checkbox"/> 2006/95/EC | <input type="checkbox"/> Annex IV
Notified Body:
Notified Body No.:
Reg. No.: |
| <input type="checkbox"/> 2006/28/EC | |
| <input type="checkbox"/> 2005/32/EC | <input type="checkbox"/> 2000/14/EC_2005/88/EC |
| <input checked="" type="checkbox"/> 2004/108/EC | <input type="checkbox"/> Annex V |
| <input type="checkbox"/> 2004/22/EC | <input type="checkbox"/> Annex VI
Noise: measured L_{WA} = dB (A); guaranteed L_{WA} = dB (A)
P = KW; L/O = cm
Notified Body: |
| <input type="checkbox"/> 1999/5/EC | |
| <input type="checkbox"/> 97/23/EC | |
| <input type="checkbox"/> 90/396/EC | <input type="checkbox"/> 2004/26/EC
Emission No.: |
| <input type="checkbox"/> 89/686/EC_96/58/EC | |

**Standard references: EN 14492-2; EN 60204-32;
EN 55014-1; EN 55014-2; EN 61000-3-2; EN 61000-3-3**

Landau/Isar, den 08.06.2010

Weichselgartner/General Manager

Wentao/Product-Management

First CE: 09

Art.-No.: 22.551.24 I.-No.: 11020

Subject to change without notice

Archive-File/Record: 2255120-02-4155050-09

Documents registrar: Markus Jehl
Wiesenweg 22, D-94405 Landau/Isar

11. GUARANTEE CERTIFICATE

Dear Customer,

All of our products undergo strict quality checks to ensure that they reach you in perfect condition. In the unlikely event that your device develops a fault, please contact our service department at the address shown on this guarantee card. Of course, if you would prefer to call us then we are also happy to offer our assistance under the service number printed below. Please note the following terms under which guarantee claims can be made:

1. These guarantee terms cover additional guarantee rights and do not affect your statutory warranty rights. We do not charge you for this guarantee.
2. Our guarantee only covers problems caused by material or manufacturing defects, and it is restricted to the rectification of these defects or replacement of the device. Please note that our devices have not been designed for use in commercial, trade or industrial applications. Consequently, the guarantee is invalidated if the equipment is used in commercial, trade or industrial applications or for other equivalent activities. The following are also excluded from our guarantee: compensation for transport damage, damage caused by failure to comply with the installation/assembly instructions or damage caused by unprofessional installation, failure to comply with the operating instructions (e.g. connection to the wrong mains voltage or current type), misuse or inappropriate use (such as overloading of the device or use of non-approved tools or accessories), failure to comply with the maintenance and safety regulations, ingress of foreign bodies into the device (e.g. sand, stones or dust), effects of force or external influences (e.g. damage caused by the device being dropped) and normal wear resulting from proper operation of the device. This applies in particular to rechargeable batteries for which we nevertheless issue a guarantee period of 12 months.

The guarantee is rendered null and void if any attempt is made to tamper with the device.

3. The guarantee is valid for a period of 3 years starting from the purchase date of the device. Guarantee claims should be submitted before the end of the guarantee period within two weeks of the defect being noticed. No guarantee claims will be accepted after the end of the guarantee period. The original guarantee period remains applicable to the device even if repairs are carried out or parts are replaced. In such cases, the work performed or parts fitted will not result in an extension of the guarantee period, and no new guarantee will become active for the work performed or parts fitted. This also applies when an on-site service is used.
4. In order to assert your guarantee claim, please send your defective device postage-free to the address shown below. Please enclose either the original or a copy of your sales receipt or another dated proof of purchase. Please keep your sales receipt in a safe place, as it is your proof of purchase. It would help us if you could describe the nature of the problem in as much detail as possible. If the defect is covered by our guarantee then your device will either be repaired immediately and returned to you, or we will send you a new device.

Of course, we are also happy offer a chargeable repair service for any defects which are not covered by the scope of this guarantee or for units which are no longer covered. To take advantage of this service, please send the device to our service address.

Einhell UK Ltd
Morpeth Wharf
Twelve Quays
Birkenhead, Wirral
CH41 1LF

Tel. 0151 6491500, Fax 0151 6491501

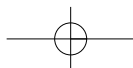
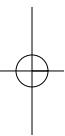

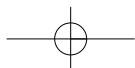
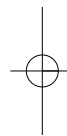
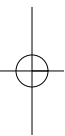



IAN: 54354 PSZ 250 A1
Einhell Germany AG
Wiesenweg 22
D-94405 Landau/Isar

Last Information Update: 06/2010
Ident.-No.: 22.551.24 062010 - 6

