

ozito

CORDLESS SCREWDRIVER TORCH

3.6V Lithium Ion

INSTRUCTION MANUAL

SPECIFICATIONS

Voltage:	3.6V
Chuck Size:	6.35mm Magnetic
No Load Speed:	180/min
Torque Settings:	9
Max Torque:	3.5Nm
Battery:	1.5Ah Li-ion
Charge Time:	3 - 5Hours
Weight (tool only):	0.4kg

ozito.com.au

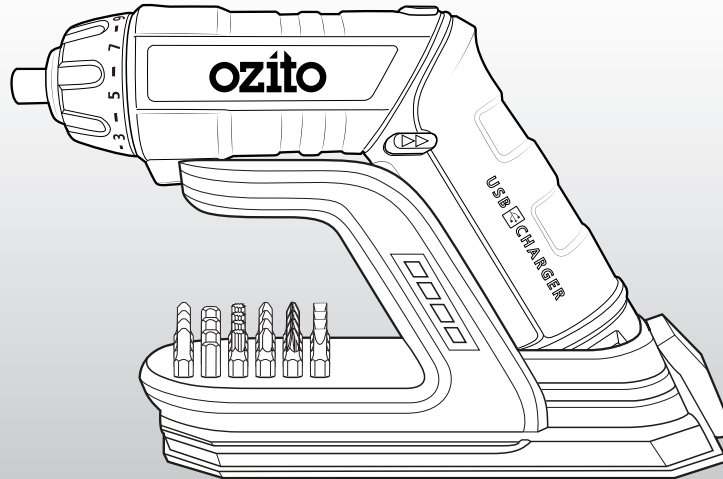

WHAT'S IN THE BOX



Cordless Screwdriver

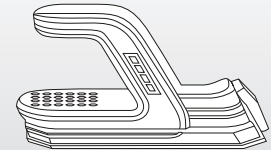

Docking Station

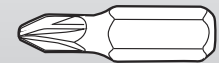

Driver Bits x 24

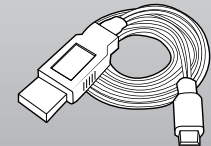

USB Charging Cable

3 YEAR REPLACEMENT WARRANTY

SDL-5000

KNOW YOUR PRODUCT

CORDLESS SCREWDRIVER / TORCH

- | | |
|---------------------------|------------------------|
| 1 Bit Holder | 7 On / Off Trigger |
| 2 Torque Collar | 8 USB Charging Point |
| 3 LED Work Light | 9 Charge Indicator |
| 4 Forward / Reverse Lever | 10 Torch On/Off Switch |
| 5 Handle Lock Button | 11 Torch LED |
| 6 Rotating Rear Handle | |

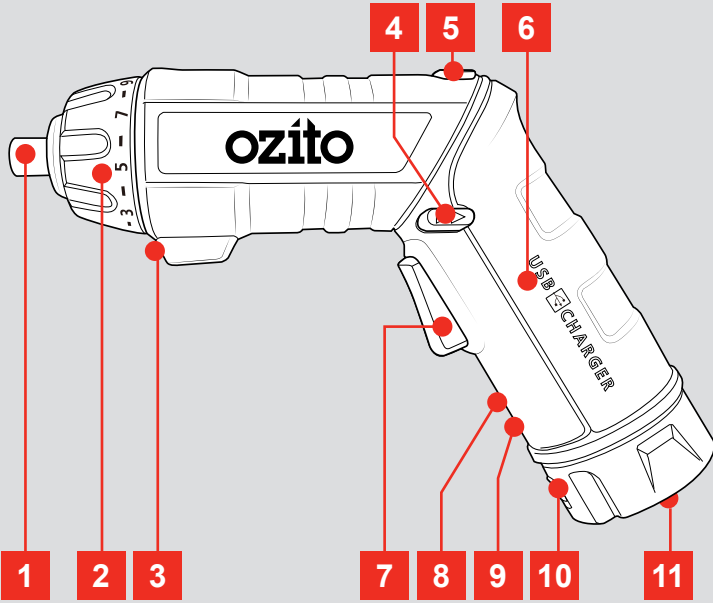

ACCESSORIES

- | | |
|----------------------------|-----------------------|
| 12 Drill Bit Storage | 16 Clear Case Lock |
| 13 Docking Station | 17 USB Charging Cable |
| 14 Charge Check Indicator | 18 CRV Bits x 24 |
| 15 USB Charger Compartment | |

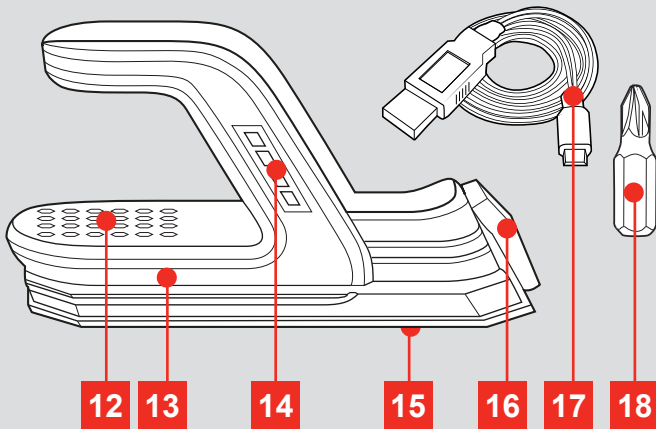

ONLINE MANUAL

Scan this QR Code with your mobile device to take you to the online manual.



SETUP & PREPARATION

1. CHARGING

Charging the Screwdriver / Torch

- 1 Remove the USB charging adaptor from the base of the docking station.

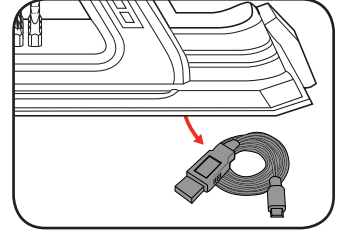

- 2 Plug the USB charging cable into a USB portable charge pack (not included) or USB port.

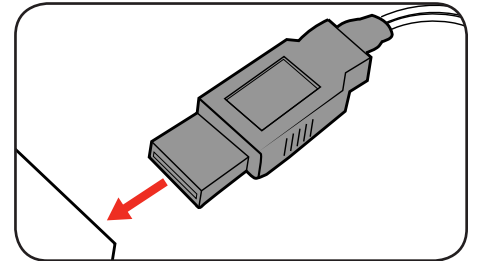

- 3 Plug the charging jack into the charging point on the screwdriver.

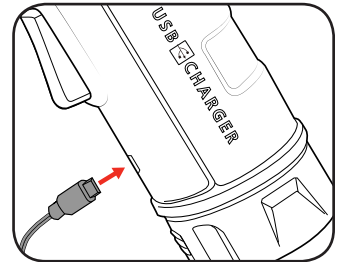

- 4 The charge indicator will illuminate red indicating the battery is charging.

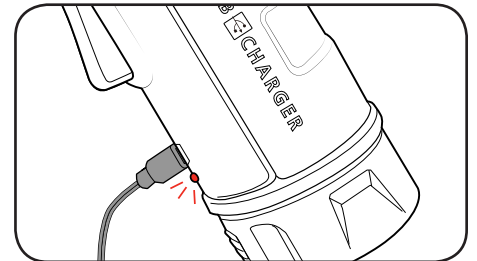

- 5 The charge indicator will illuminate green once the tool is completely charged.

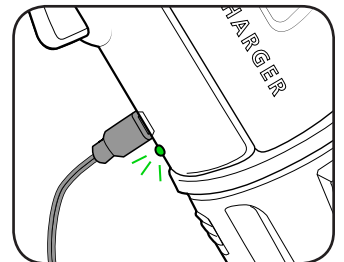

3 YEAR REPLACEMENT WARRANTY

2. DOCKING STATION

Charging with the Docking Station

The docking station allows neat and tidy storage of the screwdriver bits, while ensuring your screwdriver is always charged and ready to go.

- 1 Remove the USB charging adaptor from the base of docking station.

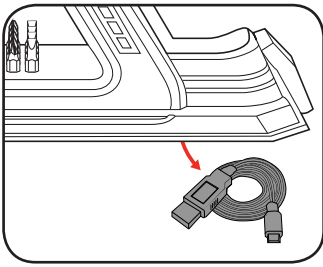

- 2 Plug the USB charging cable into a USB portable charge pack (not included) or USB port.

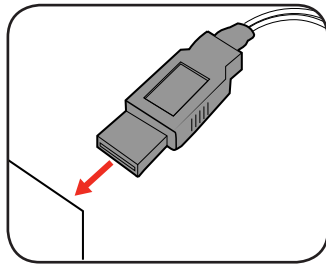

- 3 Plug the charging jack into the charging point on the docking station.

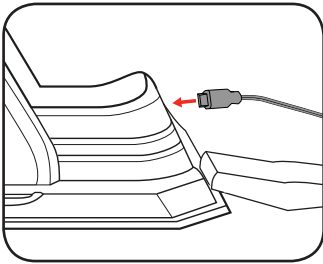

- 4 Place the screwdriver / torch onto the docking station to allow the tool to charge.

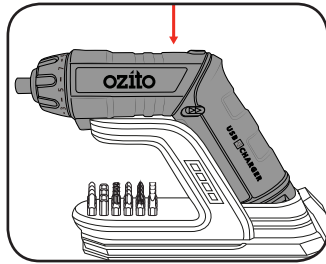

- 5 The docking station indicator lights illuminate in sequence, indicating the tool is charging.

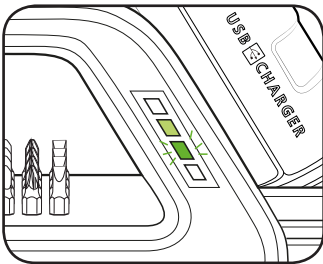

- 6 When the tool is completely charged, all 4 indicator lights will illuminate.

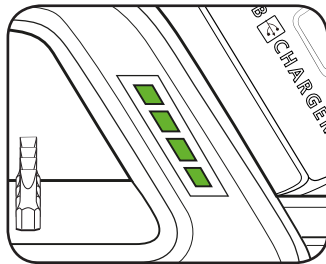

3. CHANGING DRIVER BITS

Inserting Driver Bits

- 1 Insert the CRV bit directly into the magnetic bit holder.

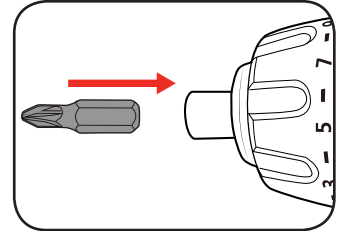

- 2 Pull gently on the CRV bit to ensure it is properly secured.

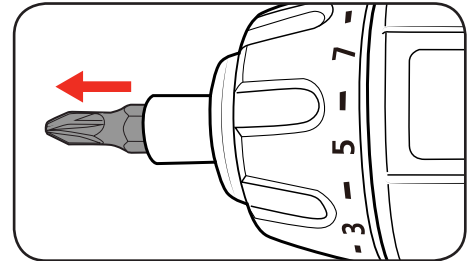

Removing Driver Bits

- 1 Pull the CRV bit out of the magnetic bit holder to remove.

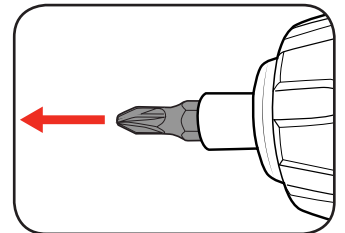

OPERATION

4. CONTROLS

On/Off Trigger

- 1 To start driving, squeeze the on/off trigger.

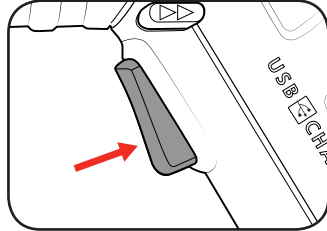

- 2 To stop driving, release the on/off trigger.

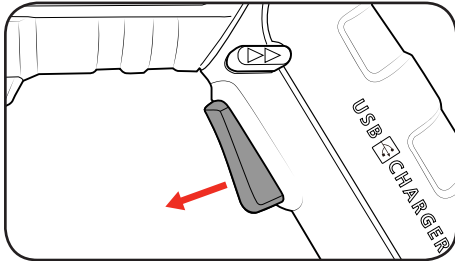

Forward / Reverse Lever

- 1 Push the forward/reverse lever left, for forward rotation.
- 2 For reverse rotation push the lever to the right of the tool.

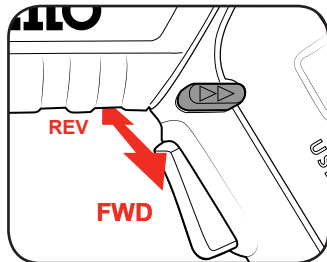

Adjusting the Torque

Align the arrow at the top of the tool with the desired setting by rotating the torque collar.

Note: A higher number will result in higher torque or twisting action.

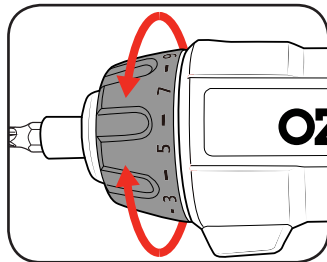

Note: To avoid damaging screw heads, start with a low torque setting and increase until the screw head is flush with the work piece.

Screwdriving LED Worklight

The screwdriver features a worklight that will help brighten the work area. This light will automatically turn on once the on/off trigger is pressed.

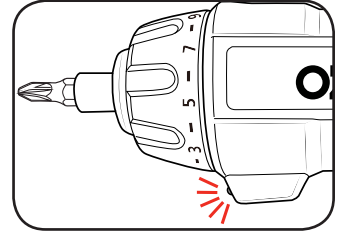

Using the Torch Function

- 1 To turn the torch on, press torch on/off switch into the on position.

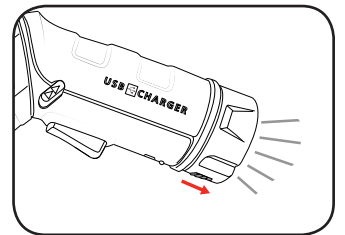

- 2 To turn the torch off, press torch on/off switch into the off position.

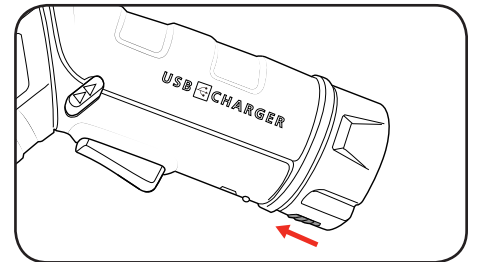

5. SWIVEL HANDLE

The screwdriver / torch features a rotating handle to suit a range of applications. You can operate the screwdriver or torch in either handle position.

In-line Position

- 1 Hold the handle locking button down.

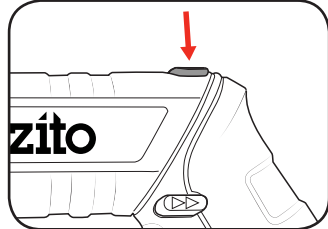

- 2 Rotate the handle clockwise until it clicks into position.

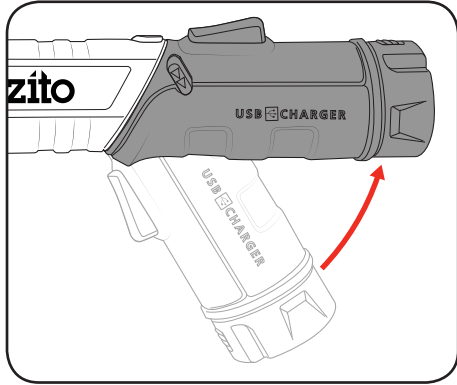

Angled Position

- 1 Hold the handle locking button down.

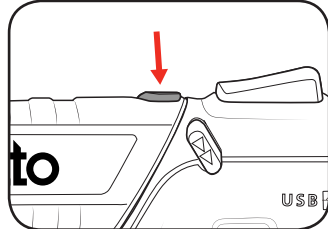

- 2 Rotate the handle anti-clockwise until it clicks into position.

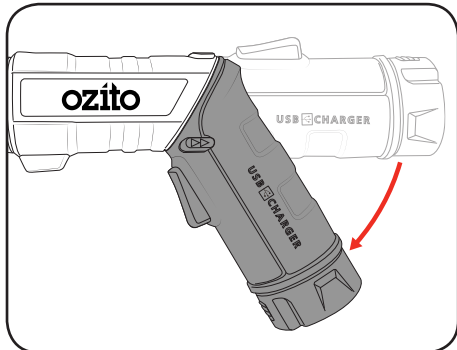

6. SCREWDRIVING

- 1 Select the desired handle position.

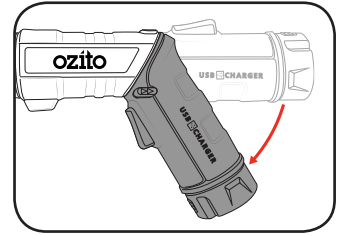

- 2 Check the forward/reverse lever is in the desired setting.

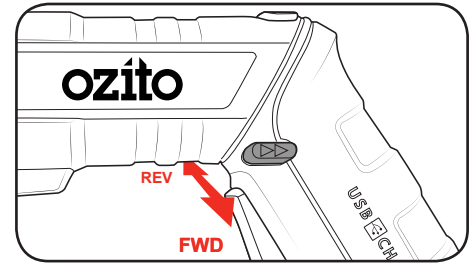

- 3 Hold the screwdriver firmly and place the bit on the screw to be fastened.

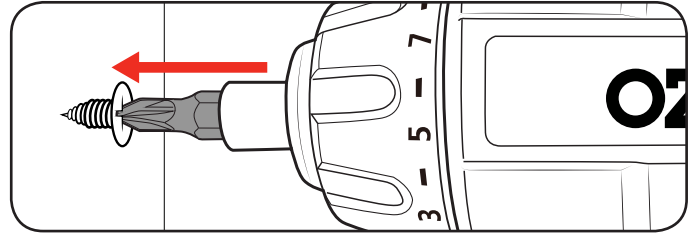

- 4 Squeeze the on/off trigger to start the screwdriver.

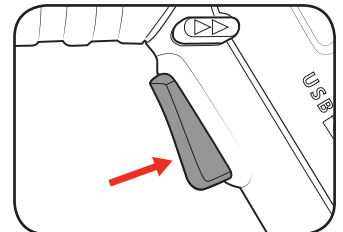

- 5 Fasten the screw into the work piece.

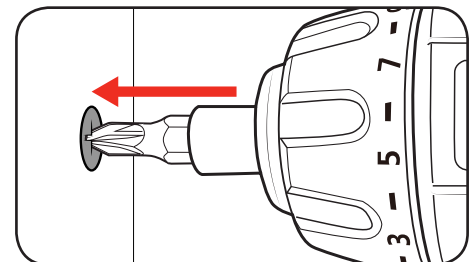

Note: Do not force the screwdriver or apply side pressure to elongate the hole. Let the screwdriver do the work.

TROUBLESHOOTING

On/Off Trigger is Locked

Ensure that the forward / reverse lever is in the correct position; pressed left for forwards direction, pressed right for backwards direction. If it is in between the two settings the on/off trigger will be locked.

LED Torch is Not Working

The tools battery may be depleted. Charge the tool using the USB charger provided.

The Handle Is Not Rotating

Ensure you are holding the handle lock button down while rotating the handle. Ensure you are rotating the handle in the correction direction. Clockwise rotation into in-line position or anti-clockwise for angled position.

Tool is Not Charging When Placed Onto The Docking Station

Ensure that you have connected the docking station to a suitable USB port using the USB charging cable provided.

Ensure the tool is correctly seated in the docking station.

MAINTENANCE

1. When not in use, the screwdriver should be stored in a dry, frost free location, keep out of children's reach.
2. Keep ventilation slots of the screwdriver clean at all times and prevent any debris from entering.
3. If the housing of the screwdriver requires cleaning, do not use solvents but cloth only.
4. Blow out the ventilation slots with compressed air periodically .

Note: Ozito Industries will not be responsible for any damage or injuries caused by repair of the screwdriver by an unauthorised person or by mishandling of the tool.

SPARE PARTS

Spare parts can be ordered from the Special Orders Desk at your local Bunnings Warehouse.

For further information, or any parts not listed here, visit www.ozito.com.au or contact Ozito Customer Service:

Australia 1800 069 486

New Zealand 0508 069 486

E-mail: enquires@ozito.com.au

SPARE PARTS

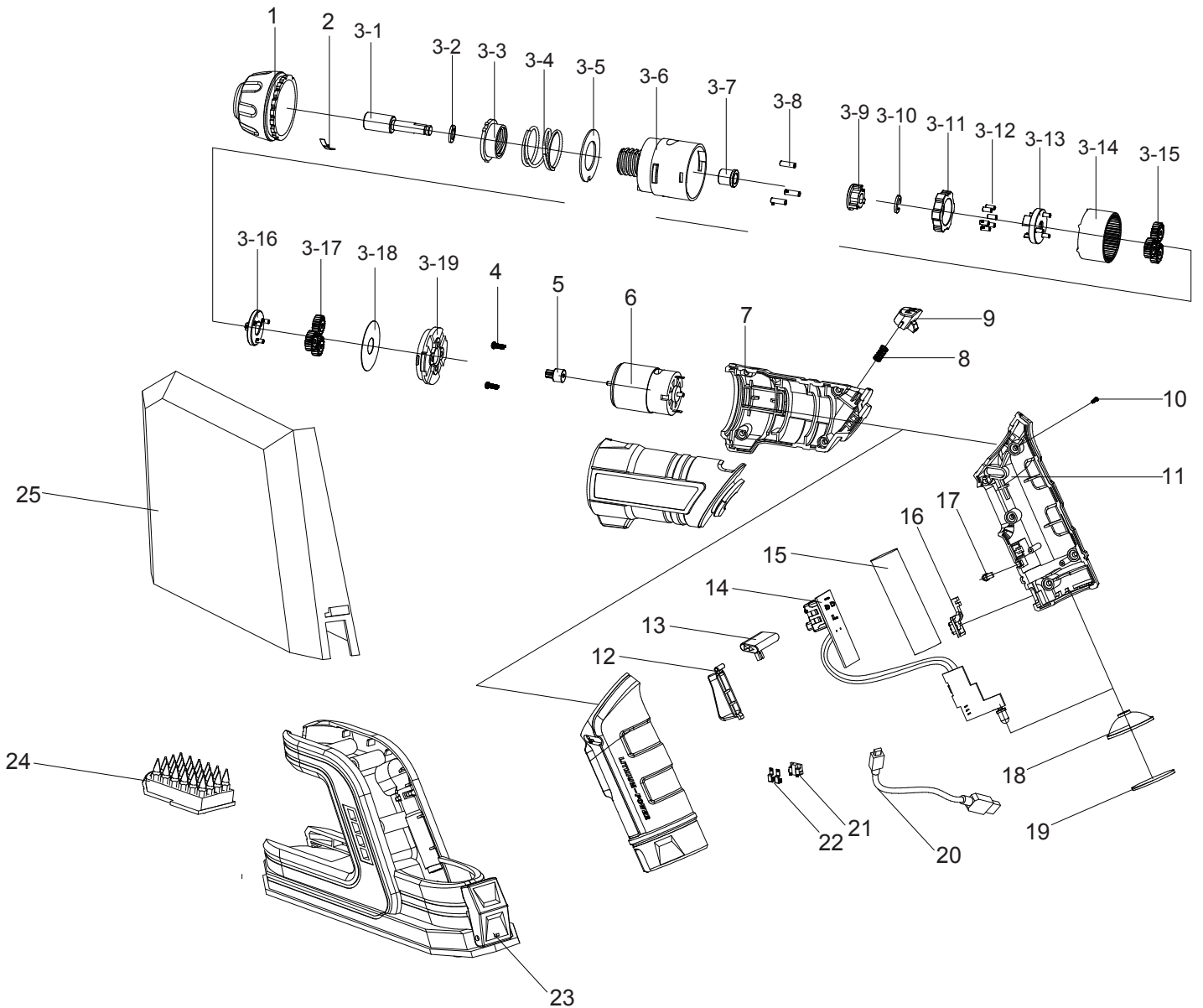

How To Order









Available spare parts can be ordered through the Special Orders Desk at any Bunnings Warehouse. If you have any further questions, please contact Ozito Customer Service on:

Australia: 1800 069 486

New Zealand: 0508 069 486

enquiries@ozito.com.au

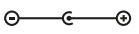
DESCRIPTION OF SYMBOLS

V	Volts	Hz	Hertz
ac/~	Alternating current	W	Watts
dc/≡	Direct current	Ah	Amp hour
mA	Milliamperes	Nm	Newton Meters
n _o	No load speed	/min	Revolutions or reciprocation per minute
	Electrical Emissions Conformity (EMC)		Transformer Energy Rating (MEPS)
	Warning		Read instruction manual
	Thermal cut-out protection		Indoor use only
	Polarity		Isolation transformer



BATTERY AND CHARGER SAFETY WARNINGS

THIS MANUAL CONTAINS IMPORTANT SAFETY AND OPERATING INSTRUCTIONS FOR YOUR BATTERY CHARGER.

- To reduce risk of damage to the electric plug and cord, pull by the plug rather than the cord when disconnecting the charger.
- Make sure the cord is located so that it will not be stepped on, tripped over, or otherwise subjected to damage or stress.
- DO NOT store or use the tool in locations where the temperature may reach or exceed 40°C (such as inside sheds or metal buildings in summer).
- The tool is not fully charged out of the carton. First read the safety instructions and then follow the charging notes and procedures.
- The longest life and best performance can be obtained if the tool is charged when the air temperature is between 18 - 24°C. Do not charge the tool in an air temperature below 10°C or above 40°C. This is important and will prevent damage to the tool.
- Do not incinerate the tool even if it is seriously damaged or is completely worn out. The battery can explode in a fire.
- Never attempt to open the tool for any reason. If the plastic housing of the tool breaks or cracks, immediately discontinue use and do not recharge.
- During charging, the tool must be placed in a well ventilated area.

CARING FOR THE ENVIRONMENT



Power tools that are no longer usable should not be disposed of with household waste but in an environmentally friendly way. Please recycle where facilities exist. Check with your local council authority for recycling advice.



Recycling packaging reduces the need for landfill and raw materials. Reuse of recycled material decreases pollution in the environment. Please recycle packaging where facilities exist. Check with your local council authority for recycling advice.



GENERAL POWER TOOL SAFETY WARNINGS - PERSONAL SAFETY

WARNING! Read all safety warnings and all instructions. Failure to follow the warnings and instructions may result in electric shock, fire and/or serious injury. Save all warnings and instructions for future reference. The term "power tool" in the warnings refers to your mains-operated (corded) power tool or battery-operated (cordless) power tool.

1. Work area safety

- a. **Keep work area clean and well lit.** Cluttered or dark areas invite accidents.
- b. **Do not operate power tools in explosive atmospheres, such as in the presence of flammable liquids, gases or dust.** Power tools create sparks which may ignite the dust or fumes.
- c. **Keep children and bystanders away while operating a power tool.** Distractions can cause you to lose control.

2. Electrical safety

- a. **Power tool plugs must match the outlet. Never modify the plug in any way. Do not use any adapter plugs with earthed (grounded) power tools.** Unmodified plugs and matching outlets will reduce risk of electric shock.
- b. **Avoid body contact with earthed or grounded surfaces, such as pipes, radiators, ranges and refrigerators.** There is an increased risk of electric shock if your body is earthed or grounded.
- c. **Do not expose power tools to rain or wet conditions.** Water entering a power tool will increase the risk of electric shock.
- d. **Do not abuse the cord. Never use the cord for carrying, pulling or unplugging the power tool. Keep cord away from heat, oil, sharp edges or moving parts.** Damaged or entangled cords increase the risk of electric shock.
- e. **When operating a power tool outdoors, use an extension cord suitable for outdoor use.** Use of a cord suitable for outdoor use reduces the risk of electric shock.
- f. **If operating a power tool in a damp location is unavoidable, use a residual current device (RCD) protected supply.** Use of an RCD reduces the risk of electric shock.

3. Personal safety

- a. **Stay alert, watch what you are doing and use common sense when operating a power tool. Do not use a power tool while you are tired or under the influence of drugs, alcohol or medication.** A moment of inattention while operating power tools may result in serious personal injury.
- b. **Use personal protective equipment. Always wear eye protection.** Protective equipment such as dust mask, non-skid safety shoes, hard hat, or hearing protection used for appropriate conditions will reduce personal injuries.
- c. **Prevent unintentional starting. Ensure the switch is in the off-position before connecting to power source and/or battery pack, picking up or carrying the tool.** Carrying power tools with your finger on the switch or energising power tools that have the switch on invites accidents.
- d. **Remove any adjusting key or wrench before turning the power tool on.** A wrench or a key left attached to a rotating part of the power tool may result in personal injury.
- e. **Do not overreach. Keep proper footing and balance at all times.** This enables better control of the power tool in unexpected situations.

- f. **Dress properly. Do not wear loose clothing or jewellery. Keep your hair, clothing and gloves away from moving parts.** Loose clothes, jewellery or long hair can be caught in moving parts.
 - g. **If devices are provided for the connection of dust extraction and collection facilities, ensure these are connected and properly used.** Use of dust collection can reduce dust-related hazards.
- ## 4. Power tool use and care
- a. **Do not force the power tool. Use the correct power tool for your application.** The correct power tool will do the job better and safer at the rate for which it was designed.
 - b. **Do not use the power tool if the switch does not turn it on and off.** Any power tool that cannot be controlled with the switch is dangerous and must be repaired.
 - c. **Disconnect the plug from the power source and/or the battery pack from the power tool before making any adjustments, changing accessories, or storing power tools.** Such preventive safety measures reduce the risk of starting the power tool accidentally.
 - d. **Store idle power tools out of the reach of children and do not allow persons unfamiliar with the power tool or these instructions to operate the power tool.** Power tools are dangerous in the hands of untrained users.
 - e. **Maintain power tools. Check for misalignment or binding of moving parts, breakage of parts and any other condition that may affect the power tool's operation. If damaged, have the power tool repaired before use.** Many accidents are caused by poorly maintained power tools.
 - f. **Keep cutting tools sharp and clean.** Properly maintained cutting tools with sharp cutting edges are less likely to bind and are easier to control.
 - g. **Use the power tool, accessories and tool bits etc. in accordance with these instructions, taking into account the working conditions and the work to be performed.** Use of the power tool for operations different from those intended could result in a hazardous situation.
- ## 5. Battery tool use and care
- a. **Recharge only with the charger specified by the manufacturer.** A charger that is suitable for one type of battery pack may create a risk of fire when used with another battery pack.
 - b. **Use power tools only with specifically designated battery packs.** Use of any other battery packs may create a risk of injury and fire.
 - c. **When battery pack is not in use, keep it away from other metal objects, like paper clips, coins, keys, nails, screws or other small metal objects, that can make a connection from one terminal to another.** Shorting the battery terminals together may cause burns or a fire.
 - d. **Under abusive conditions, liquid may be ejected from the battery; avoid contact. If contact accidentally occurs, flush with water. If liquid contacts eyes, additionally seek medical help.** Liquid ejected from the battery may cause irritation or burns.
- ## 6. Service
- a. **Have your power tool serviced by a qualified repair person using only identical replacement parts.** This will ensure that the safety of the power tool is maintained.



SCREWDRIVER SAFETY WARNINGS



WARNING! Some dust created by power sanding, sawing, grinding, drilling and other construction activities contain chemicals known to cause cancer, birth defects or other reproductive harm. Some examples of these chemicals are:

- Lead from lead-based paints
- Crystalline silica from bricks and cement and other masonry products
- Arsenic and chromium from chemically treated timber

Your risk from exposure to these chemicals varies, depending on how often you do this type of work. To reduce your exposure to these chemicals: work in a well ventilated area and work with approved safety equipment, such as dust masks that are specially designed to filter out microscopic particles.

WARRANTY

IN ORDER TO MAKE A CLAIM UNDER THIS WARRANTY YOU MUST RETURN THE PRODUCT TO YOUR NEAREST BUNNINGS WAREHOUSE WITH YOUR BUNNINGS REGISTER RECEIPT. PRIOR TO RETURNING YOUR PRODUCT FOR WARRANTY PLEASE TELEPHONE OUR CUSTOMER SERVICE HELPLINE:

Australia 1800 069 486

New Zealand 0508 069 486

TO ENSURE A SPEEDY RESPONSE PLEASE HAVE THE MODEL NUMBER AND DATE OF PURCHASE AVAILABLE. A CUSTOMER SERVICE REPRESENTATIVE WILL TAKE YOUR CALL AND ANSWER ANY QUESTIONS YOU MAY HAVE RELATING TO THE WARRANTY POLICY OR PROCEDURE.

The benefits provided under this warranty are in addition to other rights and remedies which are available to you at law.

Our goods come with guarantees that cannot be excluded at law. You are entitled to a replacement or refund for a major failure and for compensation for any other reasonably foreseeable loss or damage. You are also entitled to have the goods repaired or replaced if the goods fail to be of acceptable quality and the failure does not amount to a major failure.

Generally you will be responsible for all costs associated with a claim under this warranty, however, where you have suffered any additional direct loss as a result of a defective product you may be able to claim such expenses by contacting our customer service helpline above.

3 YEAR REPLACEMENT WARRANTY

Your product is guaranteed for a period of **36 months from the original date of purchase** and is intended for DIY (Do It Yourself) use only. If a product is defective it will be replaced in accordance with the terms of this warranty. **Lithium Ion batteries are covered by a 12 month warranty.** Warranty excludes consumable parts, for example: driver bits, etc.

WARNING

The following actions will result in the warranty being void.

- If the tool has been operated on a supply voltage other than that specified on the tool.
- If the tool shows signs of damage or defects caused by or resulting from abuse, accidents or alterations.
- Failure to perform maintenance as set out within the instruction manual.
- If the tool is disassembled or tampered with in any way.