

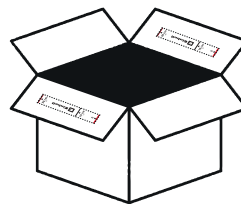

Einhell



FREELEXO 500 BT

D: Lieferumfang · GB: Scope of delivery · F: Contenu de la livraison · I: Dotazione di fornitura
E: Alcance de entrega · NL: Leveringsomvang · FIN: Toimituslaajuus · S: Leverans · EE: Tarne ulatus
PL: Zakres dostaw · P: Escopo de entrega · DK/N: Leveringsomfang · CZ: Rozsah dodávky
SK: Rozsah doručenia · H: Szállítási terjedelem

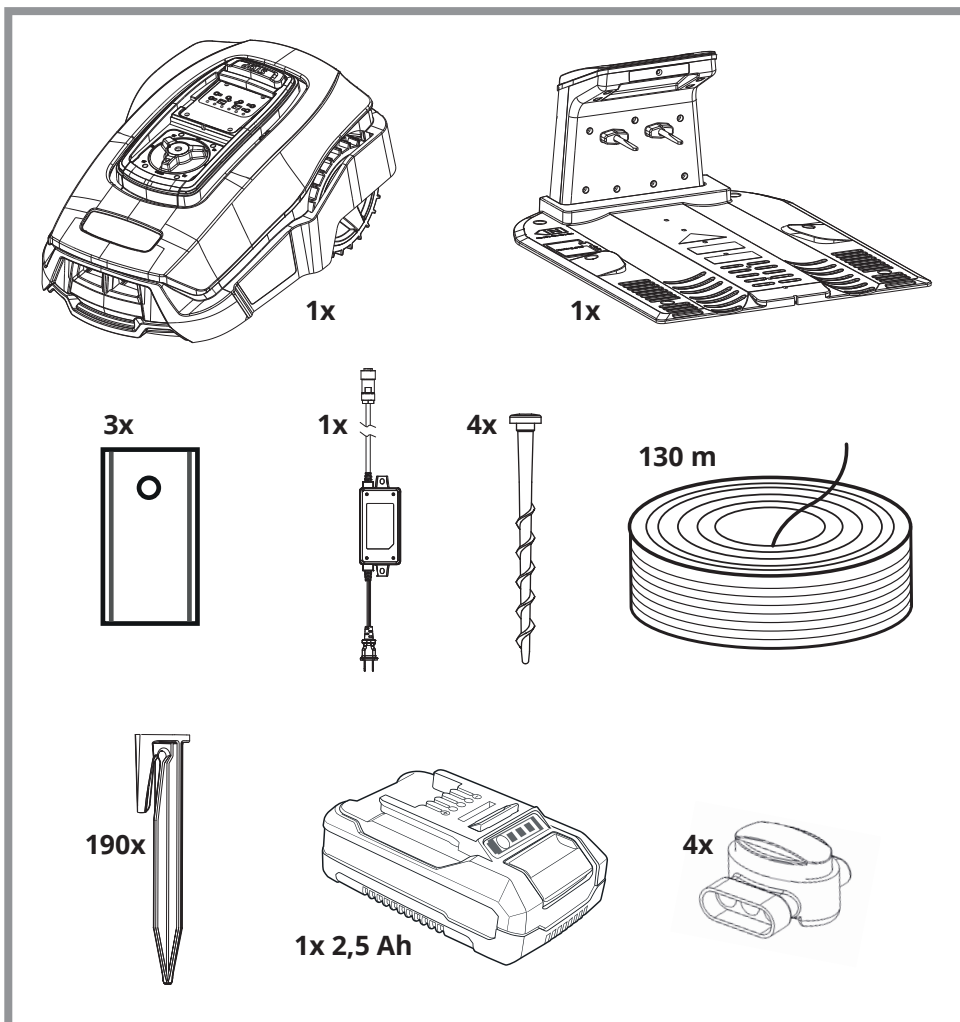

Art.-Nr.: 43.263.63

I.-Nr.: 21031

EH 09/2021 (01)