

- Ⓚ Brugsanvisning
Excentersliber
- Ⓢ Bruksanvisning
Excenterslip
- Ⓝ Bruksanvisning
Eksentersliper

Einhell[®]
bavaria

3

CE

Art.-Nr.: 44.621.03

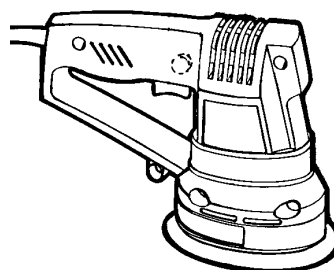

BES 115

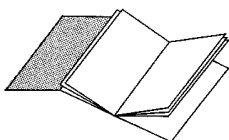

- Ⓚ Fold siderne 2 ud
- Ⓢ Fäll upp sidorna 2
- Ⓝ Slå opp på side 2

Ⓚ Tekniske data

Ⓢ Tekniska data

Ⓝ Tekniske data



230 V ~ 50 Hz



180 Watt

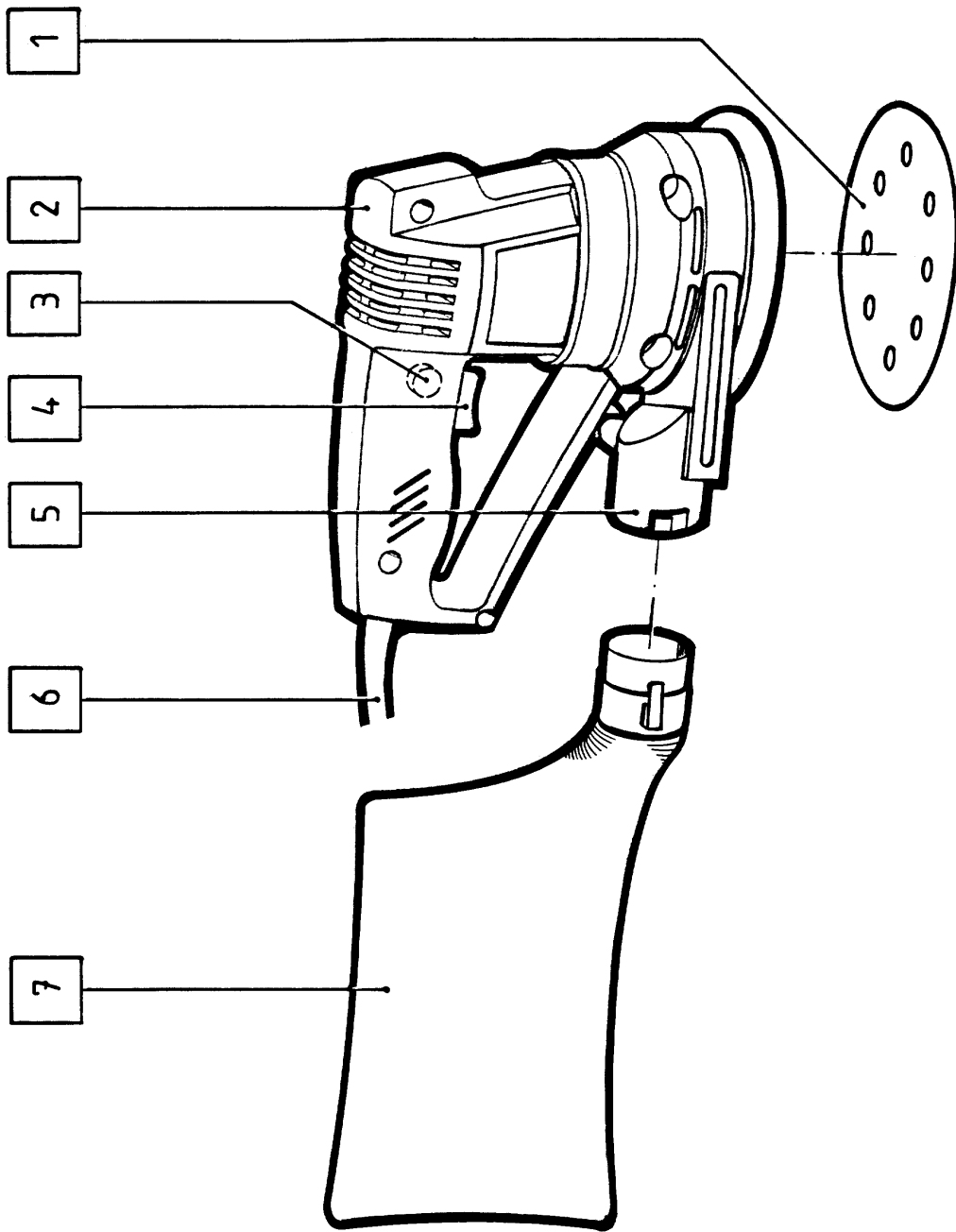

DK**Beskrivelse**

- 1 Slibepapir
- 2 Hus
- 3 Låseknop
- 4 Driftskontakt
- 5 Tilslutning til støvpose
- 6 Netkabel
- 7 Støvpose

Læs venligst brugsanvisningen nøje og vær især opmærksom på sikkerhedshenvisningerne. Opbevar brugsanvisningen sammen med excentersliberen.

Tekniske data

Spænding:	230 volt - 50 Hz
Optagen effekt:	180 watt
Slibeflade:	Ø 110
Slibepapirstørrelse:	Ø 115
Svingninger pr. minut:	10.000
Lydtrykkniveau LPA	73 dB (A)
Lydeffektniveau LWA	83 dB (A)
Vibration a_w	6 m/s ²
Vægt	1,5 kg
Dobbelisoleret	

Leverancens omfang

BES 115
Støvpose
Brugsanvisning
3x slibepapir

Generelle sikkerhedshenvisninger:

- Ved alle arbejder på maskinen (rengøring af maskinen, udskiftning af slibepapir o.lign.) skal netstikket først trækkes ud!
- Af hensyn til Deres sundhed bør De ved slibearbejder bruge støvmaske og beskyttelsesbriller!
- Sørg for at arbejdsemnet, der skal bearbejdes, er tilstrækkelig sikret mod udskridning.
- De bør for Deres egen skyld altid holde maskinen ren og efter slibearbejdet kontrollere om maskinen er blevet beskadiget.
- Skulle De konstatere beskadigelser, kan De ved hjælp af nedenstående eksplosionstegning samt listen over maskinens dele, præcist definere reservedelene og rekvirere disse gennem vores kundeservice.
- Lydtrykkniveauet på arbejdspladsen kan overskride 85 dB (A). I så fald er lyd-dæmpnings foranstaltninger for brugeren påkrævede.
- Den iflg. ISO 5349 på håndtaget målte vibrationsværdi udgør 6 m/s².

Vedligeholdelse

- Hold altid excentersliberen ren.
- Brug ingen ætsende midler til rengøringen af kunststoffet.
- Dannes uforholdsmæssigt mange gnister, skal De kontrollere kulbørsterne.
- Skulle De konstatere beskadigelser, kan De ved hjælp af nedenstående eksplosionstegning samt listen over maskinens dele, præcist definere reservedelene og rekvirere disse gennem vores kundeservice.

Vigtigt!

Af sundhedsmæssige årsager er det absolut nødvendigt at anvende støvposen!

Montering af støvposen

Støvuvsugning direkte gennem slibepapir og slibetallerken ind i støvposen

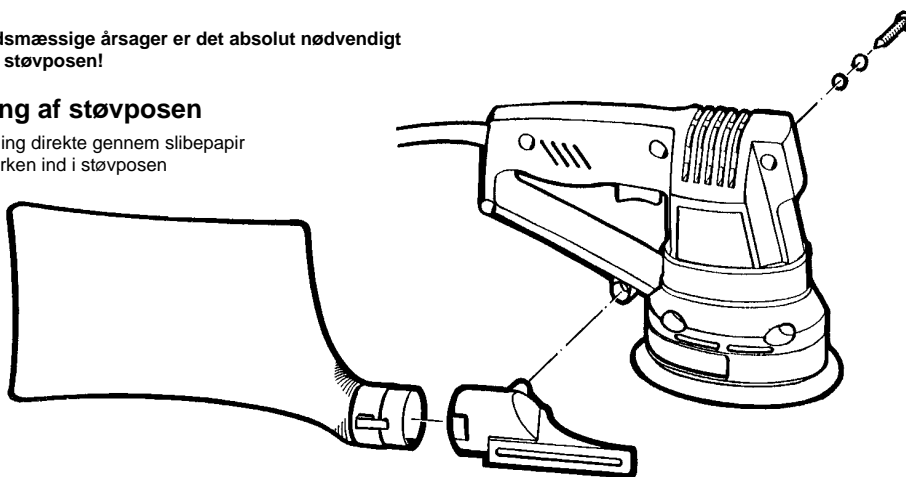

Vigtigt!

- Vær opmærksom på at der er slukket for maskinen, inden stikket sættes i stikkontakten.
- Excentersliberen er ikke egnet til efterslibning.
- Ved anvendelse af en kabeltromle, skal kablet ruller helt af (tråddiameter mindst 1 mm²).
- Træk netstikket ud, når arbejdet er afsluttet.
- Beskyt netkablet mod beskadigelse.
- Olie og syre kan beskadige kablet.
- Bær ikke maskinen i netkablet.
- Træk ikke netstikket ud ved at rykke i netkablet.
- Er maskinen defekt, opsøg da et værksted.

Tænd/sluk

Tænd	Tryk driftskontakten A ind
Konstant drift	Kontakten A sikres med låseknappen
Sluk	Tryk kort på driftskontakt A

- Maskinen kan køre i moment eller konstant drift

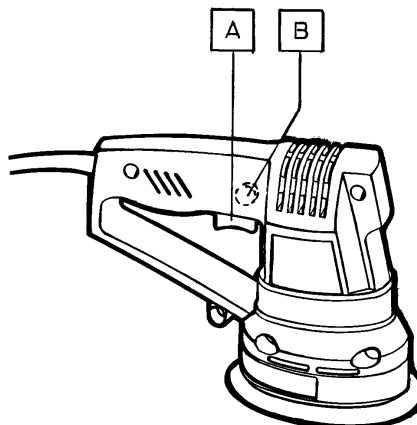

Vigtigt!

- Bær beskyttelsesbriller og støvmaske
- Hold altid ventilationsslidserne på excentersliberen rene og åbne.
- For at kunne udnytte excentersliberen optimalt, skal De altid benytte originalt tilbehør, som kan fås hos enhver fagforhandler.

Fastgørelse af slibepapir

Problemløs udskiftning ved hjælp af burrelukning. Sørg for at udsugningshullerne på slibepapiret og slibetallerkenen stemmer overens.

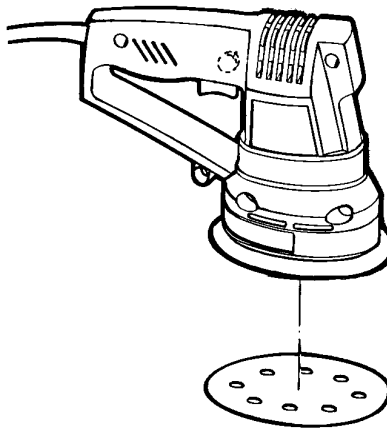

Udskiftning af slibetallerken

Efter at de 4 skruer er løsnet, kan slibetallerkenen tages af og skiftes ud.

Vigtigt!

Beskadigede slibetallerkener skal udskiftes straks, træk først netstikket ud.

Arbejdet med excentersliberen

- Sæt slibetallerkenen på med hele fladen
- Tænd for maskinen og kør med et let tryk hen over arbejdsområdet med kredsene eller krydsende bevægelser.
- Til grovslibning anbefales det at anvende en grov kornstørrelse, til finslibning en finere kornstørrelse. Ved slibepøver kan man finde frem til den mest passende kornstørrelse.

Vigtigt!

Brug åndedrætsværn og beskyttelsesbriller. Det anbefales også at bruge beskyttelseshandsker. Det er ikke tilladt at bearbejde asbestholdigt materiale.

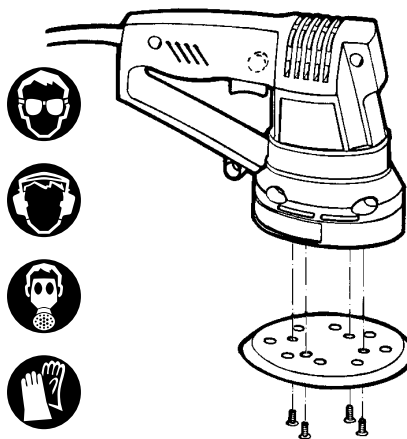

S**Beskrivning**

1. Slippapper
2. Maskinhus
3. Låsknapp
4. Driftbrytare
5. Anslutning för stoftuppsamlingspåse
6. Nätkabel
7. Stoftuppsamlingspåse

Läs noga igenom bruksanvisningen och lägg särskild vikt vid säkerhetsanvisningarna. Förvara bruksanvisningen tillsammans med excenterslipen.

Tekniska data

Spänning:	230 Volt ~ 50 Hz
Effektförbrukning:	180 Watt
Slipyta:	Ø 110
Slippappersstorlek:	Ø115
Svängningar per minut:	10.000
Ljudtrycksnivå LPA	73 dB(A)
Ljudeffektnivå LWA	83 dB(A)
Vibration a_w	6 m/s ²
Vikt	1,7 kg
Dubbel isolering	

Leveransomfattning

BES 115
Stoftuppsamlingspåse
Bruksanvisning

3x slippapper

Allmänna säkerhetsanvisningar:

- Vid alla arbeten vid maskinen (maskinen-rengöring, byte av slippapper, o.dyl.) skall först nätkontakten dras ur.
- Använd både andningsskydd och skyddsglasögon för att skydda din hälsa.
- Se till att det stycke som skall bearbetas är ordentligt fastsatt och inte kan glida iväg.
- Håll alltid din maskin ren, i eget intresse, och kontrollera efter sliparbetet att maskinen inte fått några skador.
- Skulle du finna några skador kan du, utifrån kden följande explosionsritningen såväl som reservelslistan, exakt definiera vad som behövs bytas ut och begära reservdelar hos vår kundservice.
- Bullernivån vid arbetsplatsen kan överskrida 85 dB (A). I sådana fall erfordras hörselskydd för användaren.
- Det enligt ISO 5349 uppmätta vibrationsvärdet på handtaget uppgår till 6 m/s².

Underhåll

- Håll alltid din excenterslipen.
- Använd inga frätande medel för rengöring av plasten.
- Vid alltför mycket gnistbildning kontrollera kolborstarna.
- Skulle du finna några skador kan du, utifrån den bilagda explosionsritningen såväl som reservdelslistan, exakt definiera vad som behövs bytas ut och begära reservdelar hos vår kundservice.

Varning!

Användandet av stoftuppsamlingspåsen är absolut nödvändig ur hälsosynpunkt.

Montering av stoftuppsamlingspåsen

Stoftuppsamling sker direkt från slippapper och sliptallrik i stoftuppsamlingspåsen.

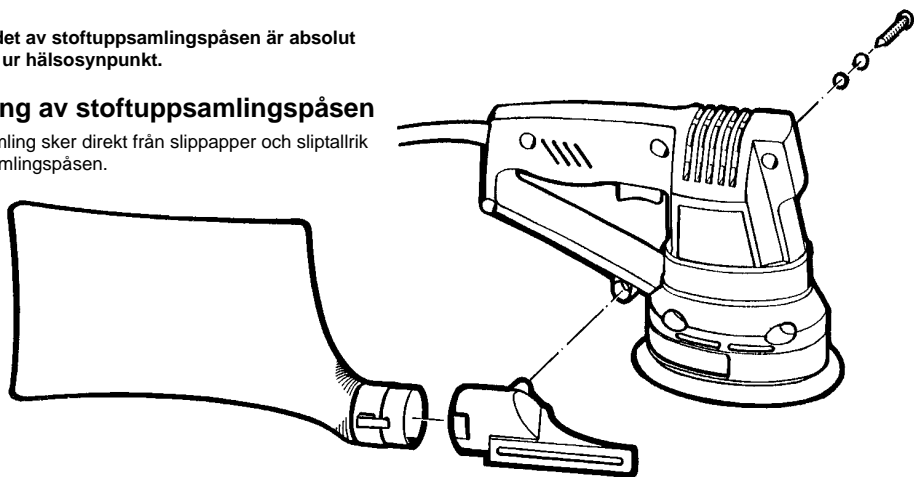

Varning!

- Se til att maskinen är fränslagen innan nätkontakten sätts i uttaget.
- Excenterslipen är inte lämpad för våtslipning.
- Vid användande av kabeltrumma måste kabeln rullas ut fullständigt (trådarea minst 1 mm²).
- Dra ur nätkontakten efter arbetets slut.
- Skydda nätsladden mot skador.
- Olja och syra kan angripa sladden.
- Lyft inte apparaten i sladden.
- Dra inte ut i nätkontakten genom att dra i nätsladden.
- Uppsök en fackverkstad om fel uppstår på apparaten.

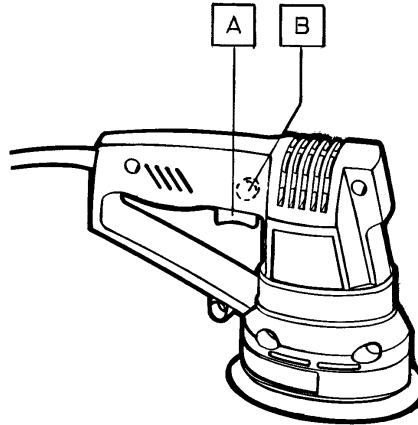

Till/Fränslag av apparaten

- Tillslag** Tryck in driftbrytaren A
Låntidsdrift Säkra driftbrytaren A med låsknappen B
Fränslag Tryck kort in driftbrytaren A

- Maskinen kan drivas i momentan- eller långtidsläge.

Varning!

- Bär skyddsglasögon och andningsskydd.
- Håll alltid luftintagen på excenterslipen rena och öppna.
- För att kunna utnyttja excenterslipen optimalt, använd alltid originaltillbehör, vilka kan fås i varje fackhandel.

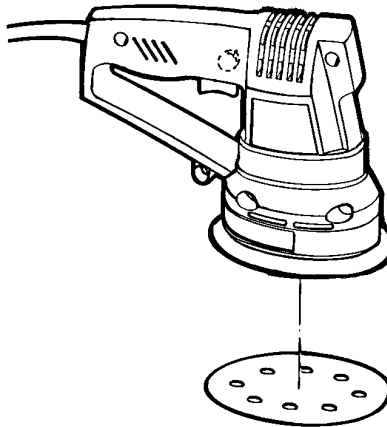

Fastsättning av slippapper

Problemfritt byte med kardborrefäste. Var noga med att utsugningshålen i slippapperet och sliptallriken överensstämmer med varandra.

Byte av sliptallrik

Efter att ha lossat 4 skruvar kan sliptallriken tas loss och bytas ut.

Varning!

Byt genast ut skadade sliptallriker; dra först ur nätsladden.

Arbete med excenterslip

- Lägg an hela sliptallriken yta.
- Slå på maskinen och gör med lagom tryck roterande eller tvär- och långsgående rörelser.
- För grovslipning rekommenderas en grov kornighet, för finslipning en finare kornighet. Genom slipförsök kan den lämpligaste kornigheten fastställas.

Varning!

Bär andningsskydd och skyddsglasögon. Skyddshandskar rekommenderas. Bearbetning av asbesthaltiga material är förbjudet.

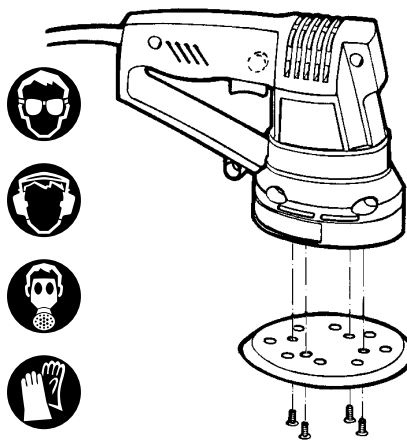

N**Beskrivelse**

- 1 Slipepapir
- 2 Avdekning
- 3 Låseknapp
- 4 Driftsbryter
- 5 Tilkopling støvoppsamlingspose
- 6 Nettledning
- 7 Støvoppsamlingspose

Les gjennom hele bruksanvisningen nøye og legg spesielt merke til sikkerhetsanvisningene. Bruksanvisningen oppbevares sammen med eksentersliperen.

Tekniske data

Spenning:	230 V ~ 50 Hz
Inngangseffekt:	180 Watt
Slipeflate:	Ø 110
Slipepapirstørrelse:	Ø 115
Svingninger pr. minutt:	10.000
Lydtrykknivå LPA	73 dB(A)
Lydeffektnivå LWA	83 dB(A)
Vibrasjon aw	6 m/s ²
Vekt	1,7 kg
Beskyttelsesisolert	

Leveransen omfatter:

BES 115
Støvoppsamlingspose
Bruksanvisning

3x slipepapir

Generelle sikkerhetsanvisninger

- Før ethvert arbeid som skal utføres på maskinen (som rengjøring, bytting av slipepapir ol.) må kontakten først dras ut!
- Av helsemessige grunner bør det benyttes støvmaske og vernebriller under slipearbeidet!
- Pass på at arbeidsstykker er tilstrekkelig sikret mot utglidning.
- I egen interesse bør maskinen alltid holdes ren og kontrolleres etter hvert slipearbeid for eventuelle skader på maskinen.
- Dersom skade er oppstått, er det mulig ved hjelp av vedlagte eksplosjonstegning og deleliste å definere reservedeler nøyaktig, som så kan bestilles hos vår kundeservice.
- Lyddempingsnivået på arbeidsplassen kan overskride 89 dB (A). Det er da nødvendig å bruke øreklokker for operatøren.
- Vibrasjon målt på håndtaket i samsvar med ISO 5349 utgjør 6 m/s².

Vedlikehold

- Hold alltid eksentersliperen ren.
- Bruk ikke etsende rengjøringsmiddel til rengjøring av kunststoffet.
- Ved overdreven gnistdannelse må kullbørsten sjekkes.
- Dersom skade kan fastslås, er det mulig ved hjelp av vedlagte eksplosjonstegning og deleliste å definere reservedeler nøyaktig, som så kan

NB!

Bruk av støvoppsamlingspose er absolutt nødvendig av helsemessige grunner!

Montering av støvoppsamlingsposen

Støvavsug direkte fra slipepapiret og slipefordelers i støvoppsamlingsposen.

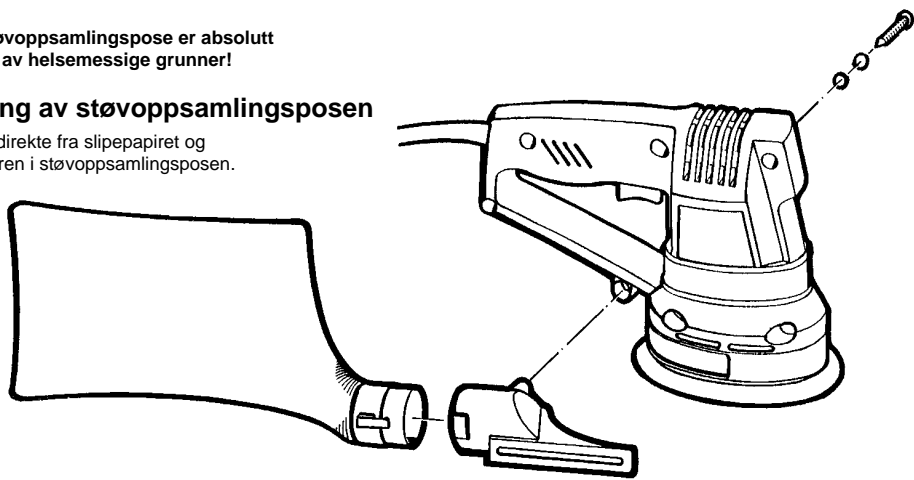

NB!

- Pass på at maskinen er avslått før kontakten settes i støpselet.
- Eksentersliperen egner seg ikke for våtsliping
- Når kabeltrommel brukes må kabelen først rulles helt av (trådtverrsnitt minst 1 mm²).
- Etter at arbeidet er avsluttet dras nettkontakten ut.
- Pass på at nettleddningen ikke skades.
- Olje og syre kan angripe ledningen.
- Apparatet bør ikke bæres med nettleddningen i.
- Dra ikke nettkontakten ut etter ledningen.
- Hvis apparatet er defekt, ta kontakt med fagverksted.

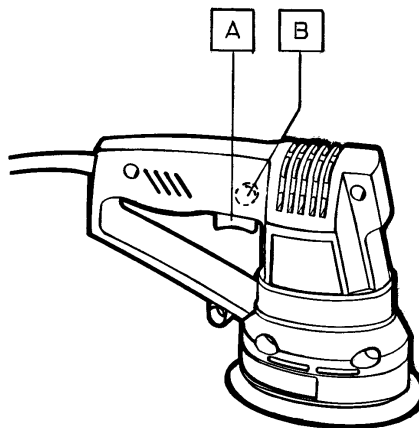

Inn-/utkopling

- Innkopling** trykk inn driftsbryter A
- Kontinuerlig drift** sikre kontakt A med låseknappen
- Utkopling** trykk driftsbryter A kort inn

- Maskinen kan nå være i kontinuerlig drift.

NB!

- Bruk vernebriller og støvmaske
- Luftbeskyttelsene på eksentersliperen må alltid holdes åpne og rene
- For å kunne udnytte eksentersliperen optimalt, bør alltid originaltilbehør benyttes, som fås i spesialforretninger.

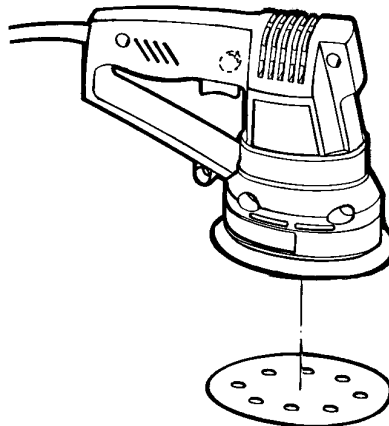

Festing av slipepapir

Utskifting foretas uten problem ved hjelp av klebelukking. Pass på sugehullene på slipepapirt og slipeplaten.

Utskifting av slipeplaten

Etter at de fire skruene er løsnet, kan slipeplaten tas av og skiftes ut.

NB!

Skadede slipeplater må skiftes ut med én gang, ta ut nettkontakten først.









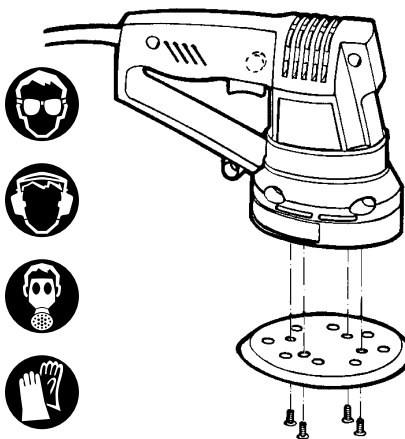

Arbeid med eksentersliperen

- Sett på slipeplaten med hele flaten.
- Slå på maskinen og utfør sirkelbevegelser eller tvers- og langsbevegelser over arbeidsstykket med jevnt trykk.
- For grovsliping anbefales grovt, for finsliping fint slipepapir. Ved hjelp av testsliping kan den mest gunstige typen fastslås.

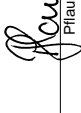

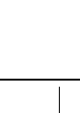

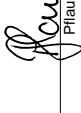

NB!

Bruk støvmaske og vernebriller. Vernehandsker anbefales også. Bearbeiding av asbestholdig material er forbudt.

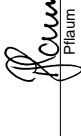

(D)	EG Konformitätserklärung Der Unterzeichnende erklärt im Namen der Firma	(GB)	EC Declaration of Conformity The Undersigned declares, on behalf of	(F)	Déclaration de Conformité CE Le soussigné déclare, au nom de	(NL)	EC Conformiteitsverklaring De ondergetekende verklaart in naam van de firma	(E)	Declaracion CE de Conformidad Por la presente, el abajo firmante declara en nombre de la empresa	(P)	Declaração de conformidade CE O abaixo assinado declara em nome da empresa
ISC GmbH · Eschenstraße 6 · D-94405 Landau/Isar											
daß die		that the		que		dat de		que el/la		que	
Maschine/Produkt		Machine / Product		la machine / le produit		machine/product		máquina/producto		a máquina/o produto	
Exzentrerschleifer		Eccentric Sander		Meuluse Excentrique		Excentriekslijper		Afiladora-esmeriladora excéntrica		Rectificadora excéntrica	
Marke		produced by:		du fabricant		merk		marca		marca	
											
BES 115											
Typ		Type		Type		type		tipo		tipo	
- Seriennummer auf dem Produkt - <input checked="" type="checkbox"/> EG Maschinenrichtlinie 89/392/EWG mit Änderungen <input checked="" type="checkbox"/> EG Niederspannungsrichtlinie 73/23/EWG <input checked="" type="checkbox"/> EG Richtlinie Elektromagnetische Verträglichkeit 89/336/EWG mit Änderungen entspricht.		- Serial number specified on the product - <input checked="" type="checkbox"/> EC Directive regarding machinery 89/392 EEC, as amended. <input checked="" type="checkbox"/> EC Directive regarding low-voltage equipment 73/23 EEC. <input checked="" type="checkbox"/> EC Directive regarding electromagnetic compatibility 89/336 EEC, as amended.		- no. série indiqué sur le produit - <input checked="" type="checkbox"/> Directive CE relative aux machines 89/392 CEE avec les modifications y apportées. <input checked="" type="checkbox"/> Directive CE relative aux basses tensions, 73/23 CEE; <input checked="" type="checkbox"/> Directive CE relative à la compatibilité électromagnétique 89/336 CEE avec les modifications y apportées.		- seriennummer op het produkt conform de volgende richtlijnen is: <input checked="" type="checkbox"/> EG machinerichtlijn 89/392/EWG met wijzigingen <input checked="" type="checkbox"/> EG laagspanningsrichtlijn 73/23 EWG <input checked="" type="checkbox"/> EG richtlijn Elektromagnetische compatibiliteit 89/336 EWG met wijzigingen		- No. de série en el producto: satisface las disposiciones pertinentes siguientes: <input checked="" type="checkbox"/> Disposición de maquinaria de la CE 89/392/CEE con modificaciones <input checked="" type="checkbox"/> Disposición de baja tensión de la CE 73/23 CEE <input checked="" type="checkbox"/> Disposición de la compatibilidad electro-magnética de la CE 89/336 CEE con modificaciones.		- cujo número de série encontra-se no produto - <input checked="" type="checkbox"/> Directiva da CE de máquinas 89/392/CEE, com alterações <input checked="" type="checkbox"/> Directiva da CE de baixa tensão 73/23 CEE <input checked="" type="checkbox"/> Directiva da CE de compatibilidade electro-magnética 89/336 CEE, com alterações	
EN 50144-1; EN 50144-2-4; EN 55014; EN 50082-1; EN 60555-2; EN 60555-3											
Landau/Isar, den	Landau/Isar, (date)	Landau/Isar, (date)	Landau/Isar, (date)	Landau/Isar, datum	Landau/Isar	Landau/Isar	Landau/Isar	Landau/Isar	Landau/Isar	Landau/Isar	Landau/Isar
23.04.98	23.04.98	23.04.98	23.04.98	23.04.98	23.04.98	23.04.98	23.04.98	23.04.98	23.04.98	23.04.98	23.04.98
											
Produkt-Management	Produkt-Management	Produkt-Management	Produkt-Management	Produkt-Management	Produkt-Management	Produkt-Management	Produkt-Management	Produkt-Management	Produkt-Management	Produkt-Management	Produkt-Management

Achivierung / For archives: **EX-0172-07-743-E**

(S)	(SF)	(N)	(GR)	(I)	(DK)
EC Konformitetsförklaring Undertecknad förklarar i firmans	EC Yhdenmukaisuusilmoitus Allekirjoittanut ilmoittaa yhtiön	EC Konfirmationserklæring Undertegetede erklærer på vegne av firma	EC Δήλωση περί της αντεπάρσεως Ο υπεγράφων δηλώνει εν ονόματι της εταιρίας	Dichiarazione di conformità CE Il sottoscritto dichiara in nome della ditta	EC Overensstemmelses-erklæring Undertegetede erklærer på vegne af firmaet
ISC GmbH · Eschenstraße 6 · D-94405 Landau/Isar					
namn, att	ni missä että	at	ότι η	che la	at
maskinen/produkten	kone/tuote	Maskin/produkt	μηχανή / το προϊόν	macchina/prodotto	maskine/produkt
Excenterslip	Epäkeskiohmakone	Eksenterslipes	Μηχανή εκτεταμένης λειτουργίας	Smerigliatrice eccentrica	Excentersliber
märke	merkki	Merke	υάρκα	marca	mærke
					
BES 115					
type	tyyppi	Type	τύπος	tipo	type
- serienummer på produktet - motsvarar <input checked="" type="checkbox"/> EU riktlinje för maskiner 89/392/EWG med ändringar <input checked="" type="checkbox"/> EU riktlinje för lågspänning 73/23 EWG <input checked="" type="checkbox"/> EU riktlinje för elektro-magnetisk kompatibilitet 89/336 med ändringar	- tuotteen valmistusnumero - vastaa <input checked="" type="checkbox"/> EU-konedirektiivik (johon on tehty muutoksia) 89/392/EWG <input checked="" type="checkbox"/> EU-pienjännitedirektiiviä 73/23 EWG <input checked="" type="checkbox"/> EU-direktiiviä 89/336 EWG (johon on tehty muutoksia) ja joka koskee sähkömagneettista mukautuvuutta (EMF)	- Serienummer på produktet - tilfredsstiller følgende retningslinjer: <input checked="" type="checkbox"/> EU Maskineimningslinje 89/392 EWG med endringer <input checked="" type="checkbox"/> EU Lovspenningsretningslinje 73 / 23 EWG <input checked="" type="checkbox"/> EU Retningslinje for elektromagnetisk kompatibilitet 89/336 EWG med endringer.	- Αριθμός σειράς: πάνω στο αντικείμενο <input checked="" type="checkbox"/> καταβύθισμα γραμμής της 392/ΕΟΚ με αλλαγές <input checked="" type="checkbox"/> καταβύθισμα γραμμής χαμηλής τάσεως της Ευρωπαϊκής Κοινότητας 73/23 ΕΟΚ <input checked="" type="checkbox"/> ηλεκτρομαγνητική ασυμβατότητας της Ευρωπαϊκής Κοινότητας 89/336/ΕΟΚ με αλλαγές.	- numero di serie sul prodotto - corrisponde <input checked="" type="checkbox"/> alla Direttiva CE sulle macchine 89/392/CEE con modifiche <input checked="" type="checkbox"/> alla Direttiva CE sulla bassa tensione 73/23 CEE <input checked="" type="checkbox"/> alla Direttiva CE sulla compatibilità elettromagnetica 89/336 CEE con modifiche	- Serienummer på produktet - opfylder <input checked="" type="checkbox"/> EU-maskindirektiv 89/392/EØF med ændringer <input checked="" type="checkbox"/> EU-lavspændingsdirektiv 73/23/EØF <input checked="" type="checkbox"/> EU-direktiv vedr. elektromagnetisk støj (EMC) 89/336/EØF med ændringer.
EN 50144-1; EN 50144-2-4; EN 55014; EN 50082-1; EN 60555-2; EN 60555-3					
Landau/Isar, den 23.04..98	Landau/Isar 23.04.98	Landau/Isar, den 23.04.98	Landau/Isar, στις 23.04.98	Landau/Isar, il 23.04.98	Landau/Isar, den 23.04.98
 Pflaum Produkt-Management	 Pflaum Produkt-Management	 Pflaum Produkt. anagement	 Pflaum Produkt-Management	 Pflaum Produkt-Management	 Pflaum Produkt-Management

Aktivierung / For archives: **EX-0172-07-743-E**

Ⓢ EINHELL GARANTIBEVIS

Garanti-perioden regnes fra købsdatoen og er gældende i 1 år.
Garantien dækker mangelfuld udførelse eller materiale- og funktionsfejl.
Nødvendige reservedele og anvendt arbejdstid ved garanti-ydelser beregnes ikke.
Der hæftes ikke for følgeskader.

Deres kundeservicekontakt

Ⓢ EINHELL GARANTIBEVIS

Garantitiden omfattar >et 1 år< och börjar löpa från och med köpedagen.
Garantin avser tillverkningsfel samt material- och funktionsfel.
Därtill nödvändiga reservdelar och uppkommen arbetstid kommer ej att debiteras.
Garantin gäller ej för på fel som uppstått på grund av nyttjandet.

Din kundtjänspartner

Ⓢ EINHELL-GARANTIDOKUMENT

Garantitiden begynner med dagen da apparatet ble kjøpt og varer 1 år.
Garantiytelsen omfatter mangelfull utføring eller material- og funksjonsfeil. Reservedeler og faktisk arbeidstid som er nødvendig for å rette på slike mangler, blir ikke beregnet.
Ingen garanti for skader som forårsakes av feilaktig bruk.

Din samtalepartner hos kundenservice

GARANTIEURKUNDE











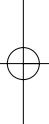
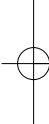
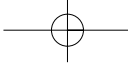



































































































































































































































































































































































Wir gewähren Ihnen ein Jahr Garantie gemäß nachstehenden Bedingungen. Die Garantiezeit beginnt jeweils mit dem Tag der Lieferung, der durch Kaufbeleg, wie Rechnung, Lieferschein oder deren Kopie, nachzuweisen ist. Innerhalb der Garantiezeit beseitigen wir alle Funktionsfehler am Gerät, die nachweisbar auf mangelhafte Ausführung oder Materialfehler zurückzuführen sind. Die dazu benötigten Ersatzteile und die anfallende Arbeitszeit werden nicht berechnet.

Ausschluss: Die Garantiezeit bezieht sich nicht auf natürliche Abnutzung oder Transportschäden, ferner nicht auf Schäden, die infolge Nichtbeachtung der Montageanleitung und nicht normgemäßer Installation entstanden. Der Hersteller haftet nicht für indirekte Folge- und Vermögensschäden.

Durch die Instandsetzung wird die Garantiezeit nicht erneuert oder verlängert. Bei Garantieanspruch, Störungen oder Ersatzteilbedarf wenden Sie sich bitte an.

ISC GmbH · International Service Center
Eschenstraße 6 · D-94405 Landau/Isar (Germany)

Ersatzteil- und Reparatur-Abt.: Telefon (0 99 51) 942 357 • Telefax (0 99 51) 26 10 und 52 50
Technische Kundenberatung: Telefon (0 99 51) 942 358

- 
- 
- 
- 
- 
- 
- 
- 
- 
- 
- 
- 
- 
- 
- 
- 
- 
- 
- 
- 
- 
- 
- 
- 
- 
- 
- 
- 
- 
- 
- 
- 
- 
- 
- 
- 
- 
- 
- 
- 
- 
- 
- 
- 
- 
- 
- 
- 
- 
- 
- 
- 
- 
- 
- 
- 
- 
- 
- 
- 
- 
- 
- 
- 
- 
- 
- 
- 
- 
- 
- 
- 
- 
- 
- 
- 
- 
- 
- 
- 
- 
- 
- 
- 
- 
- 
- 
- 
- 
- 
- 
- 
- 
- 
- 
- 
- 
- 
- 
- 
- 
- 
- 
- 
- 
- 
- 
- 
- 
- 
- 
- 
- 
- 
- 
- 
- 
- 
- 
- 
- 
- 
- 
- 
- 
- 
- 
- 
- 
- 
- 
- 
- 
- 
- 
- 
- 
- 
- 
- 
- 
- 
- 
- 
- 
- 
- 
- 
- 
- 
- 
- 
- 
- 
- 
- 
- 
- 
- 
- 
- 
- 
- 
- 
- 
- 
- 
- 
- 
- 
- 
- 
- 
- 
- 
- 
- 
- 
- 
- 
- 
- 
- 
- 
- 
- 
- 
- 
- 
- 
- 
- 
- 
- 
- 
- 
- 
- 
- 
- 
- 
- 
- 
- 
- 
- 
- 
- 
- 
- 
- 
- 
- 
- 
- 
- 
- 
- 
- 
- 
- 
- 
- 
- 
- 
- 
- 
- 
- 
- 
- 
- 
- 
- 
- 
- 
- 
- 
- 
- 
- 
- 
- 
- 
- 
- 
- 
- 
- 
- 
- 
- 
- 
- 
- 
- 
- 
- 
- 
- 
- 
- 
- 
- 
- 
- 
- 
- 
- 
- 
- 
- 
- 
- 
- 
- 
- 
- 
- 
- 
- 
- 
- 
- 
- 
- 
- 
- 
- 
- 
- 
- 
- 
- 
- 
- 
- 
- 
- 
- 
- 
- 
- 
- 
- 
- 
- 
- 
- 
- 
- 
- 
- 
- 
- 
- 
- 
- 
- 
- 
- 
- 
- 
- 
- 
- 
- 
- 
- 
- 
- 
- 
- 
- 
- 
- 
- 
- 
- 
- 
- 
- 
- 
- 
- 
- 
- 
- 
- 
- 
- 
- 
- 
- 
- 
- 
- 
- 
- 
- 
- 
- 
- 
- 
- 
- 
- 
- 
- 
- 
-

