



Einhell

BLUE

BT-LC 500 Log Cutting Saw

Art.-No. 43.071.90

The BT-LC 500 is an extremely sturdy, powerfully and comfortably Firewood-Drag Saw, which offers highest industrial safety despite its high cut achievement. With its 450 mm TCT-saw blade it is optimally suitable for sawing branches and logs. The punched barbs avoid the rotation of the saw goods. A high-quality coating protects the machine securely against corrosion. The BT-LC 500 is ready for use after a few grips. The carriage allows an easy transport of the machine.

Features

- Compensator with return spring and barbs (1)
- Length stop for exactly cutting to length
- Compensator extension for longer logs (2)
- Carriage (3)
- Sturdy underframe (4)
- Emergency-off switch (5)
- Broad handle (6)

Technical data

- Mains: 230 V ~ 50 Hz
- Power: 2,200 W S2 10 min / 1,600 W S1
- Rotation speed: 2,850 min⁻¹
- Saw blade: Ø 450 x Ø 30 x 3.0 mm; 40 teeth
- Cutting performance max.: (reversing tool) Ø 190 mm
- Product weight: 57.6 kg

Logistic Data

- Net weight: 57.6 kg
- Gross weight: 64.9 kg
- Packing dimensions: 775 x 715 x 985 mm
- Bar code: 4006825 562231
- Sales unit: 1 pc

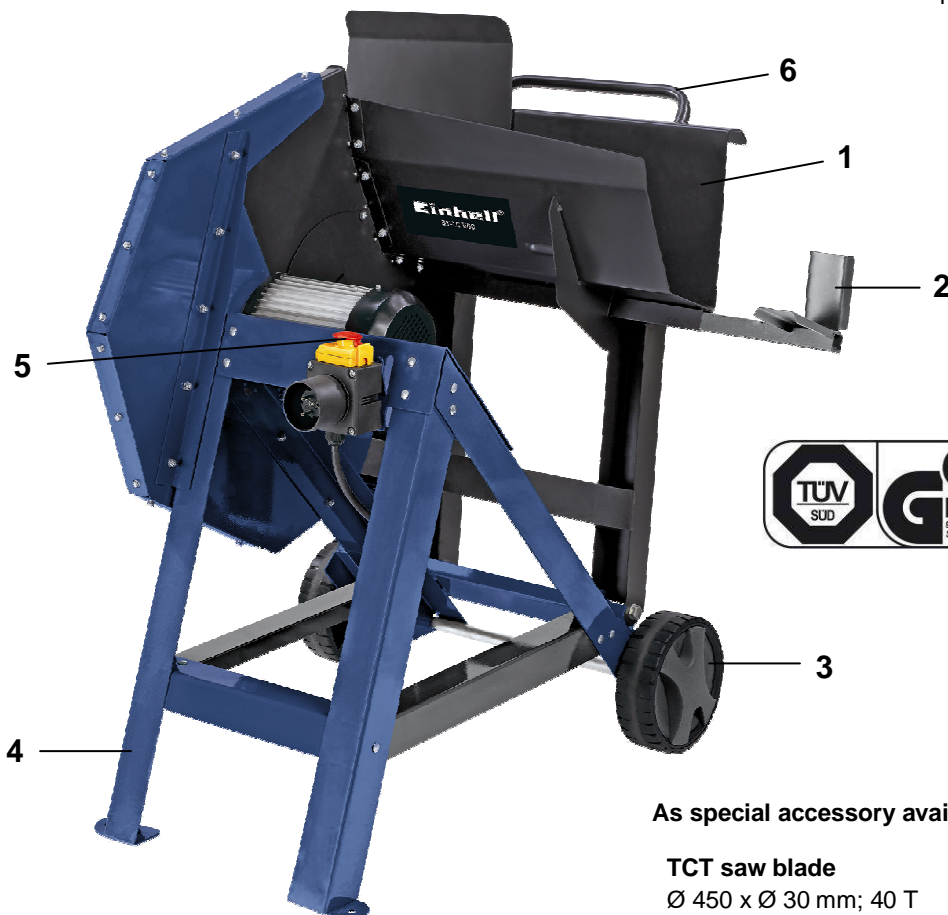

As special accessory available:

TCT saw blade
Ø 450 x Ø 30 mm; 40 T

Art.-No.: 45.020.95
Bar code: 4006825 562583