

GB **Operating Instructions for the
Indoor and Outdoor Device**

Einhell[®]

Split-system Air Conditioner



Important note:

This high-quality product will only offer optimum service if installed correctly and in the right place, and is put into operation for the first time by a suitably competent person. Avoid malfunctions by seeking competent advice from an expert with regards to the location, installation and starting up of the system.

We shall accept no liability for malfunctions or inadequate cooling performance resulting from the improper handling of the product.

Only a suitably qualified firm is permitted to undertake any work of making the electrical and cooling system connections and putting the system into operation for the first time.

If the system is to be moved to another location or disposed of, only a suitably qualified electrician's/cooling system firm is permitted to undertake any work of disassembly or disposal.



Art.-Nr.: 23.653.22

I.-Nr. 01012

SKA 3500 C+H

1. Safety instructions

- Read the safety instructions before you start to use the device.
- These points set out extremely important precautionary measures that you must comply with.
- Keep the Operating Instructions in a safe place once you have read them.
- Check that the drainage line is correctly connected. If not, water will escape.
- **Warning!**
Do not extend the cable and never use multiple plugs. A poor electrical connection, poor insulation or voltage which is higher than permitted can cause fire.
- **Remove all dirt from the power plug and plug it in firmly. Soiled plugs can cause fire or an electric shock.**
- **Warning!**
- Never pull out the plug while the device is in use.
- Never permit cool air to be blown directly at you for any lengthy period of time.
- In the event of any abnormalities (e.g. smell of burning), immediately switch off the device and pull the plug. Contact your service partner.
- Never poke fingers or sticks in the air inlet and outlet vents.
- Never attempt to repair the air conditioner yourself. Always contact your service partner if it requires repair.
- Never pull the plug out by pulling on the cable. Hold the plug firmly and pull it out of the plug socket, otherwise there is a risk of damaging the cable.
- Always switch off the device and pull the plug before you start to clean it.
- Never actuate any switches with wet hands.
- Never clean the air conditioner with water.
- Never place any plants or animals under a location to which cool air flows as this could have an undesirable affect on them.
- Never use combustible cleaning agents as these could cause a fire or deformation.
- If the air conditioner is to be used in conjunction with other heaters, the air should be refreshed periodically, otherwise there is a risk of lack of oxygen.
- Never use the device for any other purpose than the intended use. Never place food, precision instruments, plants, animals, paint, etc. on the device.
- Never hold any burning objects close to the device if they could be directly affected by the emitted air.
- Always pull out the power plug if the device is not going to be used for any lengthy period of time. Collections of dust can cause fire.
- Never step onto the outdoor device and never place anything on it.
- Never use an unsteady or rusty base.
- Never allow the device to run for too long with the doors or windows open, or if the humidity is very high. If the air conditioner runs for a long time in cooling mode and the humidity is high (over 80%), condensed water may drip out of the device.
- Never stand on an unsteady base when you remove the device from the holder on the wall.
- Check that the condensation water can run off unhindered. Water damage can result if the condensation water cannot run off properly.
- Never touch any metal parts on the indoor device when removing the air filter. You may injure yourself.
- Never install the device in a room in which combustible gases can be emitted. Emitted gases may collect and cause an explosion.
- Always switch off the device and pull out the power plug during a storm. Electrical parts may get damaged.
- Earthing connection!
The power cable (plug) comes with an earthing wire. Do not, therefore, change the plug.
- For electrical safety purposes we recommend that you install an earth-leakage circuit-breaker.
- Have all electrical installation work performed by a qualified electrician.
- Ask a service partner or specialist cooling system firm to undertake all work of cooling system-related installation.
- Incorrect installation may cause injury or damage to the device.

2. Technical data

Cooling capacity	3,500 watts
Heating capacity	3,800 watts
Energy efficiency	B (EER 3.02/COP 3.42)
Air capacity	520 m ³ /h
Absorbed humidity	1.3 l/h
Timer	24 h
Operating voltage	230 V ~ 50 Hz
Nominal power consumption, cooling	1,320 watts
Nominal power consumption, heating	1,360 watts
Compressor	Rotary piston
Outdoor temperature, cooling operation °C	+21 - +43 (DB)
Outdoor temperature, heating operation °C	+7 - +24 (DB)
Fluid line Ø A	6 mm
Suction pipe Ø A	12 mm
Length of refrigerant line supplied	4 m
Length of refrigerant line, max.	15 m
Max. difference in height between indoor/outdoor device	5 m
Refrigerant	R 407 C
Refrigerant filling capacity	900 g
Refrigerant refill quantity from 5 m	20 g/m
Sound pressure level	
Inside	≤ 40 dB (A)
Outside	≤ 55 dB (A)
Dimensions	
Inside	79 x 27,5 x 18 cm
Outside	83 x 54,5 x 25,5 cm
Weight	
Inside	10 kg
Outside	36 kg

Note:

The specified capacities and performances are based on the following conditions (ISO 5151):

Cooling:

Air temperature at the inlet on the indoor device: 27°C for dry thermometer bulb (DB), 19°C for wet thermometer bulb (WB). Outdoor air temperature: 35°C for dry thermometer bulb (DB), 24°C for wet thermometer bulb (WB).

Heating:

Air temperature at the inlet on the indoor device: 20°C for dry thermometer bulb (DB), 15°C for wet thermometer bulb (WB). Outdoor air temperature: 7°C for dry thermometer bulb (DB), 6°C for wet thermometer bulb (WB).

3. Description of parts

● Indoor device

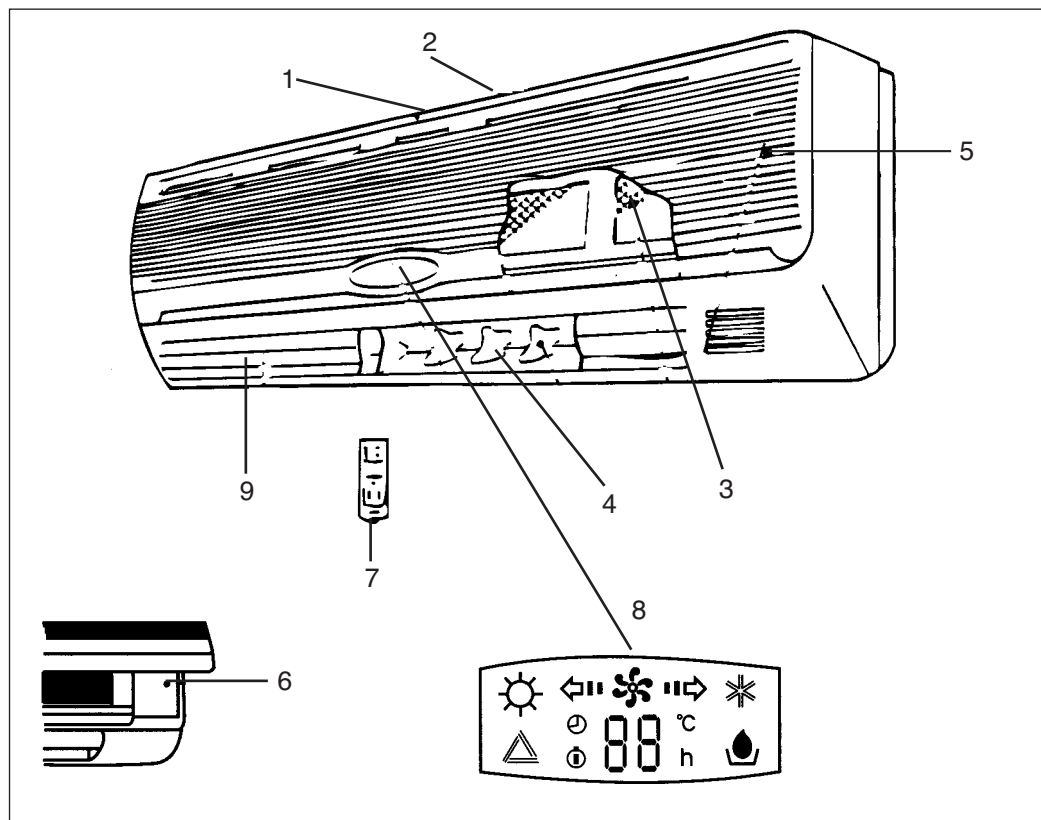

- 1 Front panel
- 2 Air outlet vent
- 3 Air filter
- 4 Left / right slats
- 5 Controller
- 6 Emergency switch
- 7 Remote control
- 8 Color display
- 9 Top / bottom slats

● Outdoor device

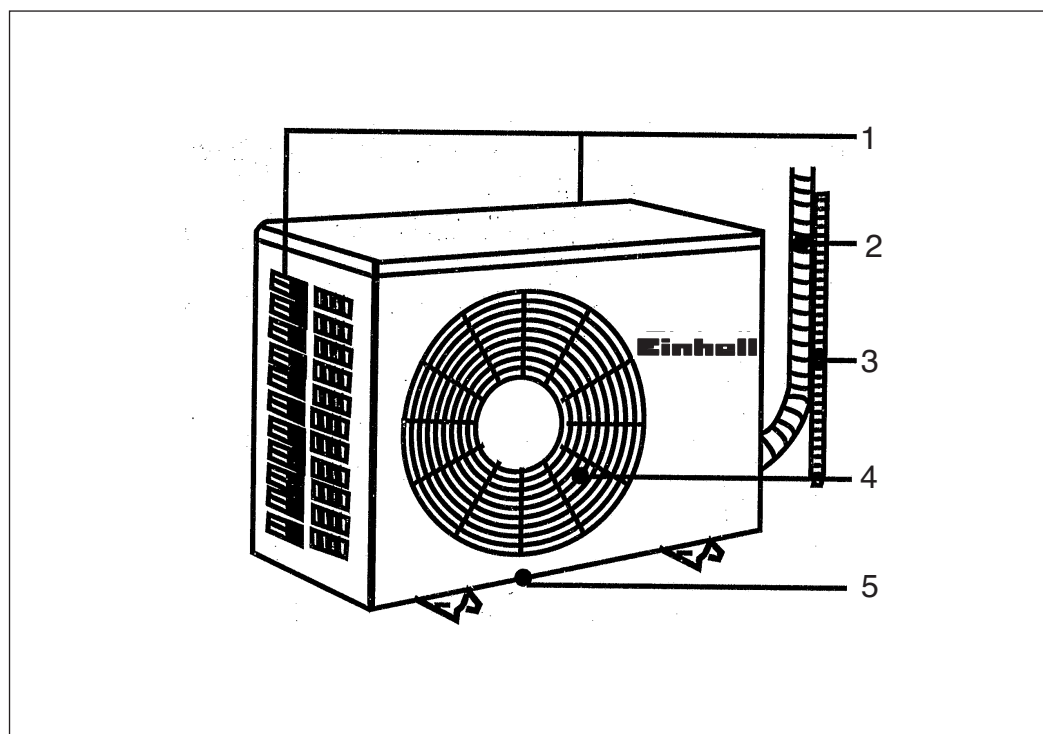

- 1 At the rear: air inlet
- 2 Hose package
- 3 Water drainage hose
- 4 Air vent
- 5 Water drainage hole

4. Remote control:

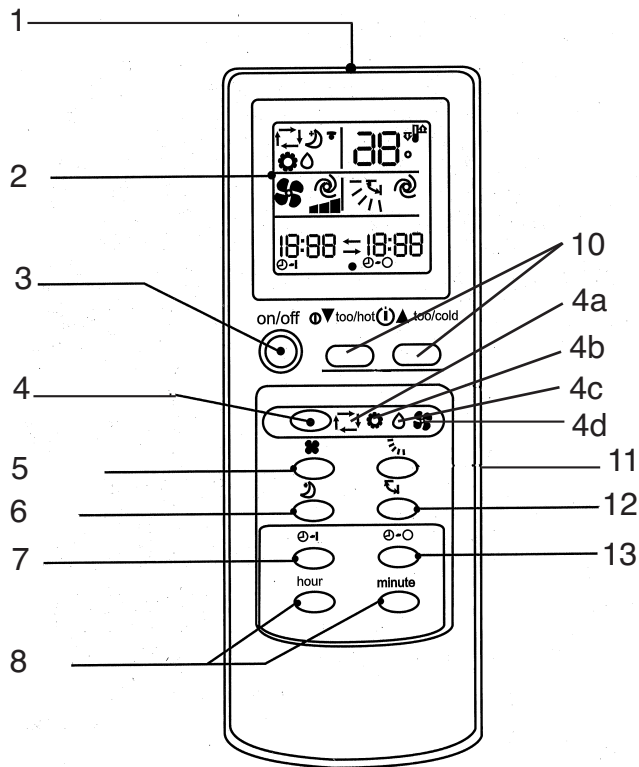

- 1 Signal output window
- 2 Function display
- 3 On/Off switch
- 4 Function switch (mode switch)
- 4a Automatic function
- 4b Cool
- 4c Dehumidify (Dry)
- 4d Heat
- 5 Switch for air circulation velocity
- 6 Sleep selection key
- 7 Timer-on key
- 8 Hours selection switch, minute setting, time setting
- 9 Clock setting
- 10 Temperature adjustment key
- 11 Key for setting the air flow angle
- 12 Full blast key
- 13 Timer-off key
- 14 Reset key
- 15 Battery cover opener

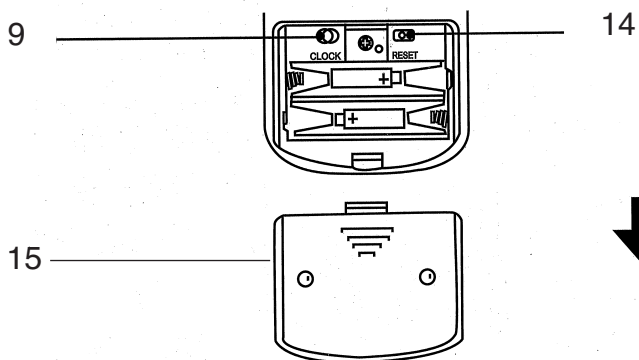

Preparing to use the remote control for the first time and setting the current time.

1

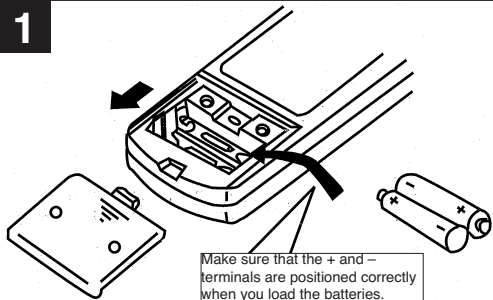

Make sure that the + and - terminals are positioned correctly when you load the batteries.

Open the rear cover and insert the batteries.

2

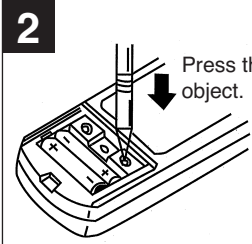

Press the reset key with a pointed object.

Always press the reset key once after every battery change.
Do not forget to do so, otherwise normal operation will not be possible.

3

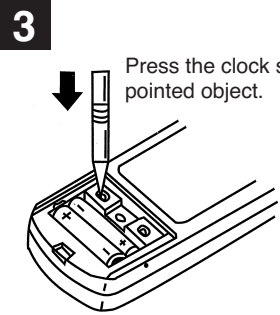

Press the clock setting key with a pointed object.

4

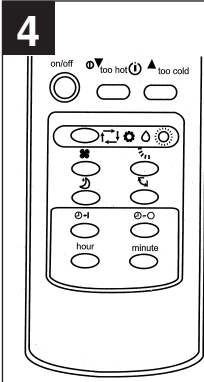

Press the hours/minutes with the time setting key and set the right time.
Press the hours key and set the hours.
Press the minutes key and set the minutes.
(Please take AM=24.00-12.00 or PM=12.00-24.00 into account!)

5

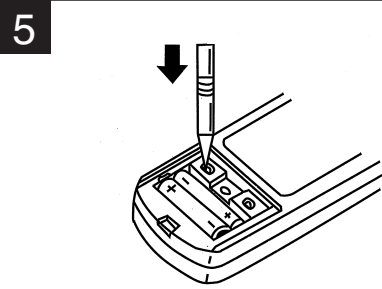

Now press the clock setting key again and replace the cover on the back.

Preparation for use of the remote control

- The radio signal has a range of approx. 6 m.
 - When the ON/OFF button is pressed, the indoor device will emit an audio signal once or twice to indicate that the device has received the signal.
 - If you do not hear a signal, press again.
 - Handle the remote control with care and, in order to avoid malfunctions, never drop it or leave it in a damp location.
- Attach the remote control to the wall in such a way that the receiver on the indoor device can receive the remote control signal effectively.

Changing the batteries!

- If the signal on the remote control becomes weak or the indicator on the remote control becomes difficult to read, replace the batteries **immediately**.
- It is important that the + and – terminals on the batteries are correctly positioned in the remote control.
- Both batteries should always be new and of the same make.

Remote control fails to work (emergency operation)

If the remote control fails to work (empty batteries or malfunction), use the emergency switch.

When you press the key, the function changes in the following sequence:

- Cooling - Stop.

For the first 30 minutes the temperature adjustment does not yet function.

Function	Cooling
Set temperature	24°C
Air speed	Medium
Air flow slats	Automatic

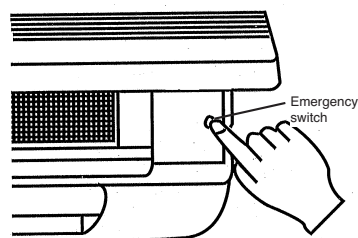

The function in question is indicated on the indoor device.



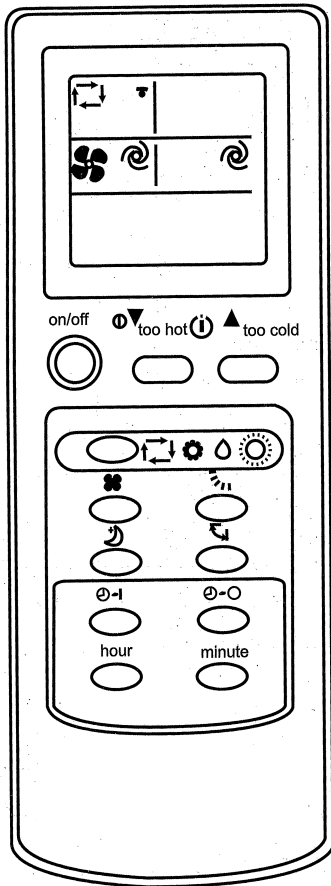

"I feel ..." automatic function

A light press of the automatic function "I feel" can produce a comfortable room temperature.



To start
Press the ON/OFF KEY 
 If  automatic function is indicated, the air conditioner switches to a comfortable room temperature.

To stop,
Press the ON/OFF KEY 
 15 minutes after switching off, you may feel that it is possibly a little too hot. To reduce the temperature a little, press the key  (too hot). Each press of the key will reduce the temperature by 1° C.
 If it is too cold, increase the temperature with the key  (too cool). Each press of the key will increase the temperature by 1° C.

LCD display for the indoor

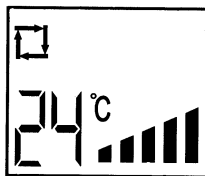

Low/high indicator

If the automatic function is not shown, press key “4” as often as is required for the automatic function (4a) to be shown.

Each time the key is pressed the sequence changes: Automatic (4a) - Cool (4b) - Dehumidify (Dry) (4c) - Heat (4d).

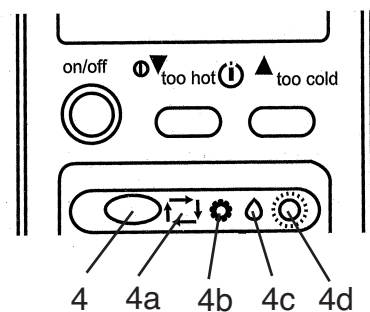

Structure of the automatic function

Operation functions.

When the automatic function is started, the mode of operation for the room temperature adjusts to the corresponding function such as cool, dehumidify, etc. If operation is stopped for 2 hours, it begins again with the same function setting that it had before it stopped. Once the corresponding function has become set, it will no longer be affected by the room temperature, even if it changes. If you do not wish to use this function, press the key in order to set one of the following functions.

Automatic function once the room temperature has been checked.

Room temperature at start temperature

Above +25°C
+21-25°C
Below 21°C

Function

Cool
Ventilate / Dehumidify
Heat

Set-point

approx. 24°C

approx. 24°C

Note:

The heat function can be used for outdoor temperatures down to +7°C. Heating is not possible if the outdoor temperature is any lower.

Selecting the mode function (cool (4b), dehumidify (4c), heat (4d)). Select Mode in order to finely adjust the room temperature or air flow.

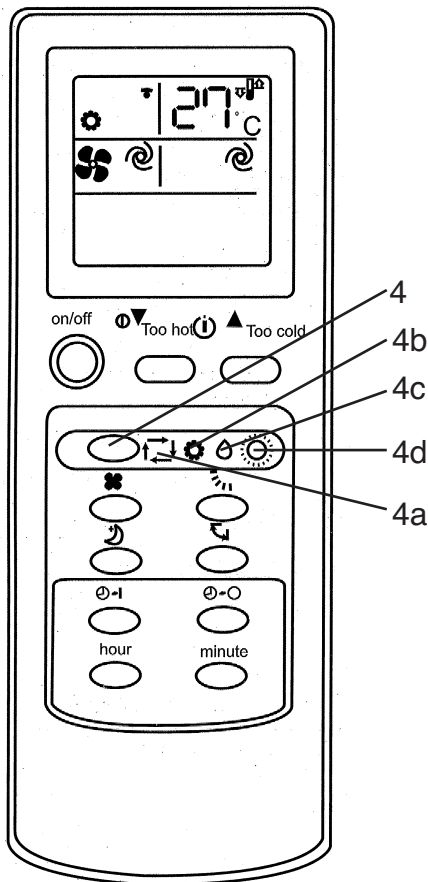

Important!
If the ambient temperature is too high the cooling system works at maximum capacity.

To select cool, dehumidify or heat:
1 Press the ON/OFF key.
2 Press to select the corresponding function.
Every time you press the key the function changes in the following sequence: Automatic - Cool - Dehumidify - Heat

If you wish to switch off the device:
Press the ON/OFF key.
Once the device has been set for the first time, all you have to do to return to the previous function is press the ON key.

Heat function:
Select the heat function with key 4.
The heat function can be used at any time as long as the outdoor temperature is above approx. +7°C. The maximum room temperature to be reached depends on the outdoor temperature and the nature of the particular building.
Note: If during operation the room temperature is more than 2°C above (cool) or less than 2°C below (heat) the set-point temperature, the set-point temperature on the air conditioner cannot be changed. As soon as the temperature difference between the room temperature and the predefined set-point temperature is less than 2°C again, it will be possible to change the set-point temperature on the air conditioner again.
The lower the outdoor temperature, the lower the room temperature that can be achieved with the heater function.

Changing the temperature

Press the "too hot" key  to reduce the temperature. Each press of the key reduces the set temperature by 1°C.

Press the "too cool" key  to increase the temperature. Each press of the key increases the temperature by 1°C.

The system can become overloaded if the air conditioner draws too much heat from the air. The fan on the outdoor device stops automatically, thanks to the microprocessor controller, to protect the air conditioner. If the fan on the outdoor device stops, the outdoor device will indicate frost. This is not a fault or malfunction.

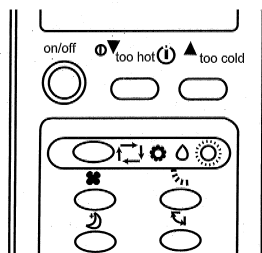

Dehumidifying mode

If the temperature is set to the automatic function, this function cannot be changed.

Selecting the function (cool, dehumidify).

Monitoring during operation:

1. In order to increase the cooling effect, close the windows and lower the roller blinds or reduce incoming sunlight.
2. Lower the venetian blinds in order to reduce incoming sunlight.
3. Install the outdoor device in a suitable place away from direct sunlight, where it will save energy.

Dehumidifying

70% air humidity is the upper limit with which the human body feels comfortable.

If it is too warm for the human body this means the water content is too high, i.e. humidity is too high. Humidity has a certain relationship to temperature. As a general rule, the following applies: 60-70% for the summer and 50-70% for the winter.

Adjusting the air velocity and air flow

Select the air flow and air circulation with which you feel most comfortable.

Select a high setting ■■■ if you wish to cool the entire room. Select the sleep function when you want to sleep and wish to reduce the noise level while sleeping.

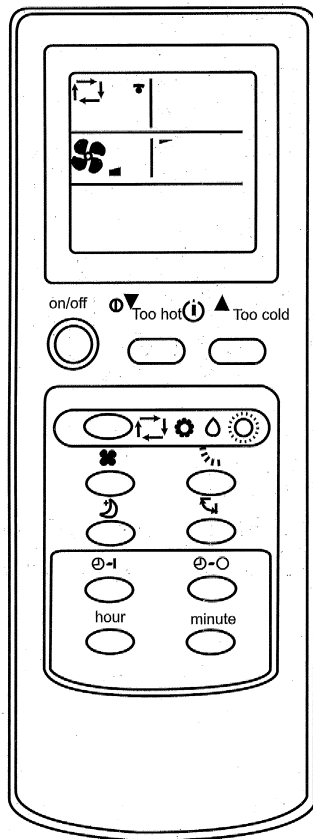

Press the  key to adjust the air velocity. Each press of the key changes the air velocity as follows: Low, moderate, high, automatic.

Press the  key to adjust the direction of the air up/down. Each press of the key changes the direction.

Recommended range for the air flow up/down. Adjust with the automatic key. Select cool, heat or dehumidify.

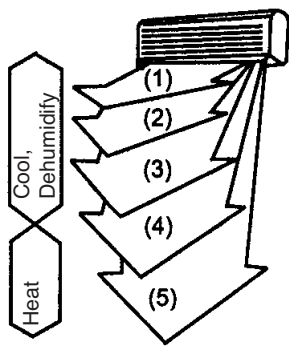

Important:

- In the dehumidify and cool function the air is blown downwards for 1 hour (Item 4 - 5). Then the device switches to horizontal air flow in order to prevent dripping.
- Adjust the up/down direction using the remote control. Never attempt to adjust the height by hand.
- If the blown-out air temperature is too cold in heat mode, the air will be blown out virtually horizontally. Adjust to the desired flow direction and velocity.

Adjusting the air velocity and direction of flow

Automatic air flow

Press the  key, change the air flow to automatic and the optimum slat position will be selected for efficient effect.

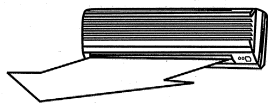

Cool + Dehumidify

In cool and dehumidify the air flows out horizontally.

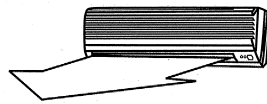

Heat

If the air temperature is cool, the air flows out horizontally.

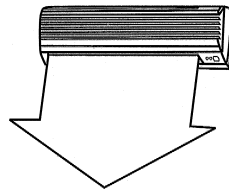

If the air is warm, the air flows out in a downward direction.

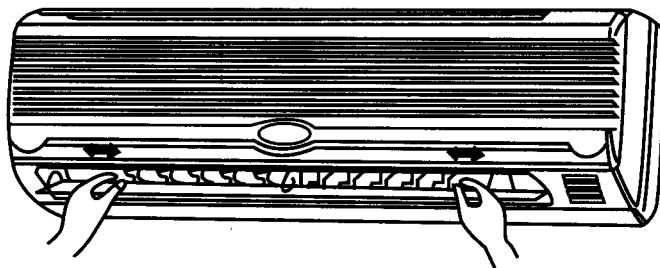



The left-hand and right-hand side flow directions can be adjusted manually.

Perform these adjustments before you start the device because once it has been started the slats vibrate and there is a risk of your fingers getting caught.

Comfortable sleep mode function

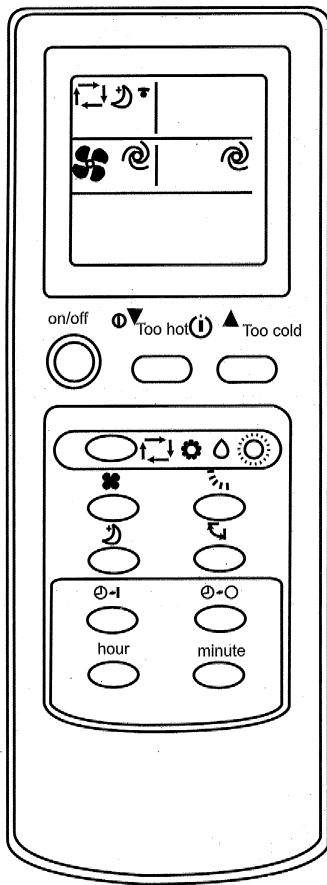
Set this function if you desire a quiet room while sleeping.



Proceed as follows:
Press the  key.
This function is for a quiet room while sleeping.

To cancel this function: Press the key  again.

Important:
Start this function just before you go to sleep. If you start it during the day it is possible that the ambient temperature will become too hot, because the cooling function is reduced.

Full blast

If this function is started, every part of the room will be cooled.

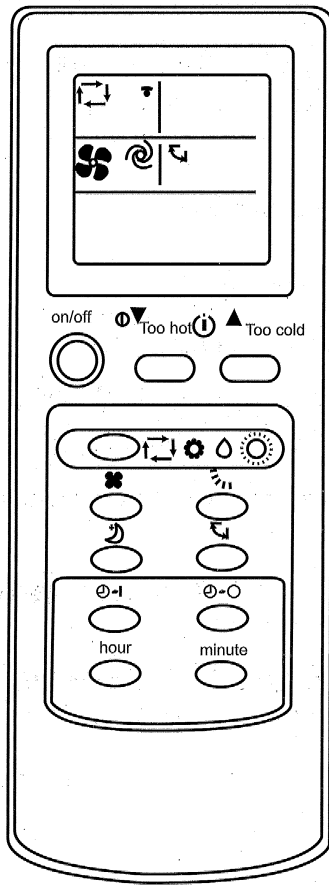

Proceed as follows:
Press the  key.

The cancel:
Press the  key again.



Press the  key during full blast to stop the operation. Once the full blast function has been started the cool air will reach every corner of the room.

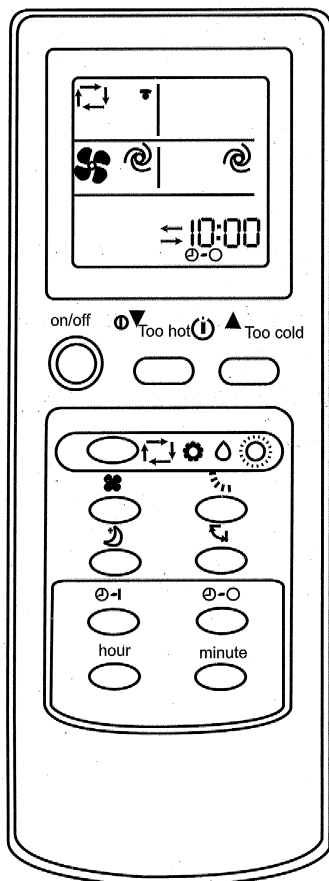

Timer mode (ON/OFF)

Set the TIMER mode before going to sleep, or for the normal time that you come home or get up in the morning.





Timer On setting

- 1 Press the  key during operation to set the timer to "ON". Each press of the key changes the sequence Start time > Cancel.
- 2 Press the hours/minutes key   to set the current time. Each press changes the time by 1 hour or 10 minutes. (AM=24.00-12.00; PM=12.00-24.00)

To cancel  Press the  key to cancel the timer setting.

Timer Off setting

- 1 Press the  key during operation to set the timer to OFF. Each press of the key changes the sequence > Timer "OFF" switch off.
- 2 Press the hours and minutes key   to set the Timer OFF to the right time. Each press changes the time by 1 hour or 10 minutes.

Switching off

Press the key  to switch off the timer.

Important note:

- Timer ON and Timer OFF can be combined, with the setting time which is closest to the actual time having priority. (— — means Timer OFF, or Timer ON follows).
- If the clock setting on the remote control has not been correctly set, this will result in an incorrect setting on the timer as well.

Important:

Always switch off the device and pull the power plug before cleaning. The high speed of the fans can cause injury.

Clean the indoor device with a soft cloth only.

Never use petrol, thinners, scouring powder, cleaners, etc., as these may cause damage to the device.

5. Tips on care

1. Clean the air filter and insert back in the original position.
2. Make sure that all inlets and outlets on the indoor and outdoor device are kept clear and are not covered or blocked.

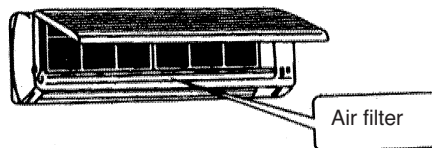

Care precautions

Before cleaning:

Always pull out the power plug.

Care precautions

If the air conditioner is not going to be used for some period of time:

1. Let the fans run for 3 - 4 hours to allow the device to completely dry out. Set the highest possible temperature level while the fans are running.
2. Switch off the device and pull the power plug.

Important:

Always pull out the power plug if the device is not going to be used for some time. Collections of dust pose a fire hazard.

3. Take the batteries out of the remote control.

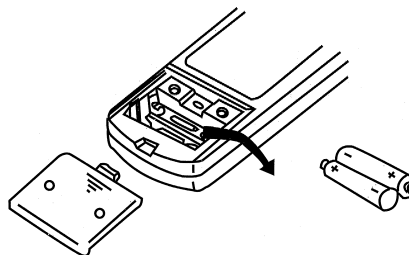

6. Troubleshooting

Before you ever contact customer services, check the following:

Device does not start. Check the following:

1. Is voltage present at the plug socket outlet?
2. Check the plug fuse!
3. Is the timer set?

The device does not provide satisfactory cooling!

Check the following:

1. Has an appropriate temperature been set?
2. Is the air filter soiled? Clean and fit back in place.
3. Are the inlets and outlets on the outdoor device blocked?
4. Has the sleep mode been set during the day?
5. Are the connections between the indoor and outdoor device adequately sealed? There may not be enough coolant? If so, please contact your service company.

The remote control does not work!

(Important! It only works within a range of 6 m from the indoor device.)

1. Are the batteries still OK? Replace if necessary!
2. Have the batteries been inserted correctly? Check that the + and – terminals are correct!

In the event of a power failure, check the following:

Press the ON/OFF key after a power failure.

If the problems remain after checking through the above points, switch off the device and contact your service company.

Troubleshooting

Problem

Cause

After pressing the start key the device is not started by the microprocessor for 3 minutes.

This is not a fault, it is for the protection of the compressor. Please have a little patience.

Crackling noises can be heard.

This is not a fault.
These tension noises are caused by the contraction and expansion of the front panel in response to temperature differences.

There is an odd smell in the room.

This is not a fault.
The air conditioner also circulates the transpiration from the walls, carpets, smoke, furniture and clothing in the air.

The fan stops during dehumidifying.

This is not a fault.
The temperature increases when water evaporates on the heat exchanger in the indoor device.

You can hear moving water.

This is not a fault.
The coolant in the air conditioner may have expanded.

The air flow changes automatically during operation.

This is not a fault.
The ventilation slats turn to a horizontal position to prevent dripping if the air has been blown downwards for approx. 1 hour in the cool or dehumidifying function. If the blast air is too cool, it will also be blown out horizontally.

There is a clicking noise inside the indoor device.

This is not a fault.
This will normally be the noise of the fan or the compressor when switching on or off.

There is a muffled noise coming from the indoor device.

This is not a fault.
This noise comes from the coolant in the air conditioner.

Water drops from the outdoor device.

This is not a fault.
During the cooling process the tube or the connection pieces cool down in order to form the condensate. During defrosting or heating the evaporation condensate may drip. During heating, water may drip from the heat exchanger.

Air is not blown out immediately in heat mode.

This is not a fault.
Air only starts to be blown out once it has been heated up.

The air conditioner switches off during heat mode.

The outdoor device freezes if the outdoor temperature is low (below approx. +7°C). Heat mode is not possible if the outdoor temperature is below approx. +7°C.

The following pages are intended for professional installers.

7. Important installation instructions

Selecting the place to install the indoor device

- The air flow must never be blocked.
- The cooled air should be capable of being distributed to all parts of the room.
- The maximum distance between the indoor and outdoor device is 15m and their maximum difference in height 5m.
- Mount on a solid wall to prevent vibrations.
- Avoid direct sunlight.
- Take into account a slight condensate run-off.

Selecting the place to install the outdoor device

- The device must not be exposed to strong gusts of wind.
- Make sure that the device is well ventilated and kept free of dust. Avoid direct exposure to rain and sunlight.
- Make sure that the operational noises and air emissions do not cause a nuisance for neighbours.
- Install on a firm base, avoiding excessive noise or vibrations.
- Avoid locations where combustible gas or leakage can be emitted.
- Fix the device's installation feet with care if the device is to be installed well above them.

Mounting accessories

Mounting plate
Screws 4x25 mm
Batteries 2 x MICRO LR03 1.5V
Remote control

Tubing accessories

Tube connector
Composite wrap-around tape
Klamb
Drainage hose
Connection cable

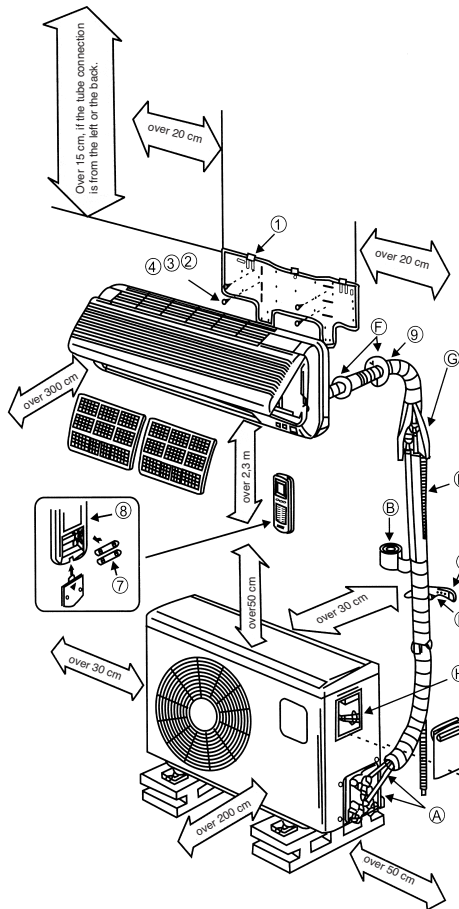

Important

Do not hesitate to contact our service partners. They will be able to give you a speedy response to all your questions so that your system can be installed correctly. We shall accept no liability for services if the air conditioner is not installed, vented and put into operation for the first time by an air conditioning specialist.

8. Installation instructions:

Check that the actual mains voltage is the same as the mains voltage specified on the rating plate.

- The device must have separate protection against short-circuits.
- Have all work of electrical installation performed by an electrician.
- Ask a service partner or specialist cooling system firm to undertake all work of installing the cooling system.
- Incorrect installation can lead to injury or damage to property.
- Always wear ear muffs, goggles and work gloves when performing work of installation.

Notes on electrical connection!

All electrical connection work must be performed by a qualified electrician authorized to do so such work by the applicable electricity supply company. The system must have separate protection against short-circuits. Select a suitably large cable cross-section. The yellow/green wire is to be used as a protective conductor only and under no circumstances as a voltage carrying conductor. The fixed electrical connection of the device must be capable of being isolated from the mains power supply by a device with an isolating distance of at least 3mm (e.g. circuit-breaker). Connect the electrical connections of the indoor and outdoor devices together first and then connect to the mains power supply. Check first that the entire system is voltage-free. Secure the system from being switched on again.

1. Selecting the place of installation

Indoor device

1. The openings for the inlet and outlet air must never be covered, otherwise the air will not be distributed throughout the entire room.
2. Install the indoor device in a location which ensures that the distance through the wall to the outdoor device is as short as possible.
3. Make sure that the drainage hose does not have any kinks or upward inclines when you connect it with the outside.
4. Do not select a location adjacent to a source of heat, high humidity or inflammable gas.
5. Select a location which is firm enough for installation so that the device is not subjected to vibrations.
6. Check that the device has been installed

correctly and exactly.

7. Make sure that there is sufficient space available for later repair and service work.
8. The device should be installed at a distance of at least 1 m from all other electrical devices and installations, e.g. TV, radio, computer, etc.
9. Select a location for the device which is easily accessible so that the filter can be cleaned or replaced without difficulty.

Outdoor device

1. Select a location which avoids causing a nuisance to neighbours from noise and air emissions from device.
2. Select a location which is sufficiently well ventilated.
3. Never cover the air inlets and outlets.
4. The location must be sufficiently firm for installation and the prevention of vibrations.
5. There must be no risk presented by combustible gas or gas escaping as a result of corrosion.
6. Check that the device is installed in accordance with regulations.

Important:

The following could cause malfunctions. Check with your service company in order to prevent possible malfunctions at a later date.

The following locations should be avoided for installation:

- A location where oil (machine oil) is stored.
- A location where there is a high salt content.
- A location with numerous sulphurous sources, e.g. spa zones.
- A location where radio transmitters or amplifier aerials, welding equipment or medical equipment are in use.
- A location where the outdoor device is exposed to direct sunlight. If necessary the device must be protected with a sun-shade. Such a sun-shade must not interfere with the air flow, however.
- A location in the vicinity of heat or steam generators.
- A location which is heavily exposed to dust.
- A location to which the general public have access.
- A location with any other unusual characteristics.

Important!

- The direction in which the air is blown should correspond with the prevailing direction of the wind.
- Never install in locations exposed to aggressive

air.

- Comply with all specified minimum distances (see Important notes on installation).
- The indoor and outdoor devices must only ever be installed in a vertical position.

2. Installing the indoor device

It is imperative that you comply with the installation instructions.

2.1 Before you start installation

- Select the location for the indoor device (follow the previous notes on selecting the location for installation).
- Check that the available mains voltage is the same as the voltage specified on the rating plate.
- Fit appropriate insulation, supplied by the customer, to the coolant tubes.

2.2 Fitting the mounting plate

- The mounting plate for the indoor device must be fitted horizontally to the wall. In doing so, it is imperative that you comply with all specified distances. Mark and drill the holes for fastening the mounting plate, and then firmly fasten with dowels and screws. In order to prevent vibrations on the indoor device, make sure that there are no gaps between the wall and the mounting plate.

2.3 Drilling the hole through the wall

- Drill the hole through the wall for the lines/hoses using a 65mm drill bit, drilling from the inside to the outside at an angle downwards of approx. 5°. Then insert the wall hole tube in the hole in the

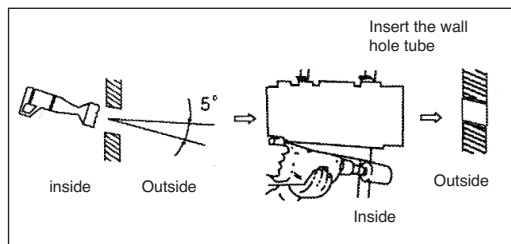

wall.

2.4 Fitting the condensation water drainage hose

- The drainage water hose must be run to the outside with a drop. It is imperative that there are no bends or kinks. The end of the drainage hose must not be situated in a container of any kind in which water can collect. Any water held back in the drainage water hose could lead to water damage.

- Slide the additional drainage hose onto the mounts on the drainage hose already fixed to the indoor device. Fasten this connection point with adhesive tape, checking that it is fully sealed as you do so. Wrap the section of the drainage hose in the hole in the wall, plus approx. 10 cm in front of the wall on both the inside and outside, in

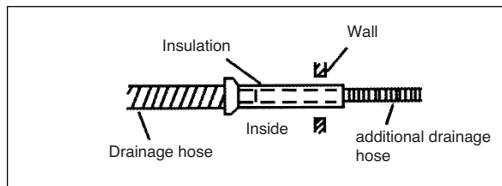

insulation material.

2.5 Wrapping the lines/hoses in protective tape

- Please note that the power cable is not to be fed through to the outside. All tubes, electric cables and the drainage water hose have to be wrapped with the supplied protective tape. Depending on whether the lines are right-hand or left-hand versions, the corresponding bushing preparations must be removed from the indoor

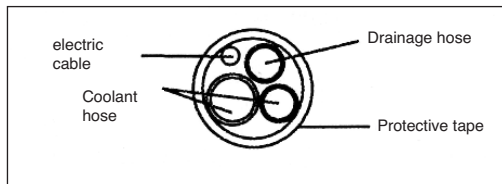

device.

2.6 Final installation of the indoor device

- Feed the package of lines/hoses through the hole in the wall.
- Fit the indoor device to the hook at the top of the mounting plate and let it lock into place at the bottom.
- The package of lines/hoses is to be laid between the housing of the indoor device and the wall. In order to prevent condensation water, insulate the package of lines/hoses with heat insulation material.

3. Assembly of the outdoor device

Have the connection cable for the outdoor device connected only by a qualified electrician

4. Connecting the coolant tubes

4.1 Important notes

- Please make sure that coolant is never allowed to enter the environment.
- Improper handling of coolant may be harmful to health. Always wear work gloves and goggles when handling coolant.
- Make sure that the work place is well ventilated at all times. Smoking is prohibited.
- The device must never be operated without the coolant tubes connected, otherwise the device will be damaged immediately.
- Ask one of our service partners or a specialist cooling system firm to connect the coolant lines and put the system into operation for the first time.

5. Remote control holder

Before you mount the holder, check that the remote control can be received by the indoor device from the planned location for the holder. Do not select a position in direct sunlight or in the vicinity of any sources of heat.

Check that the + and – terminals on the batteries are positioned correctly in the remote control.

Fasten the remote control holder to the wall with dowels and screws.

6. Electrical connections

1. Remove the fresh air connection part.
2. Remove the connection terminal and connect the mains cable to the connection element with the screws. Make sure that the wiring conforms with the indoor device.
3. Fix the wires in position with the terminal and make the necessary connections.
4. Check once again that connections are really secure.
5. Re-fasten the fresh air part.

Note:

A wrong electrical connection can cause faults in the electrical system. Do not pull on the cable when you connect it to the terminal.

Important

1. Have all service work performed by a specialist firm only. Request a copy of our list of service partners for any such work.
2. If ever the voltage carrying cable between the

indoor device and the outdoor device should be damaged, contact a specialist firm.

3. If the power cable should ever be damaged, have it replaced by an electrician.
4. Important note:
 - a) The maximum length of the coolant line in the basic version is 4 meters.
 - b) If the outdoor device is higher than the indoor device, a curve will be required in the coolant tube which is positioned below the height of the indoor device.

indoor device
ET-Nr. 23.709.21.00

Connection cable

outdoor device
ET-Nr. 23.709.25.00

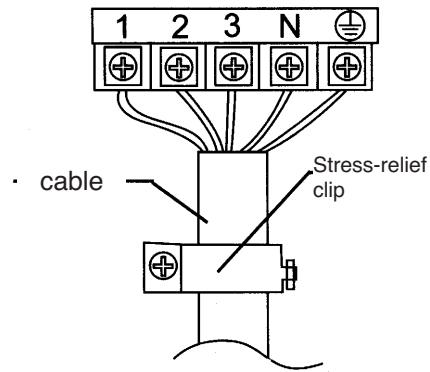
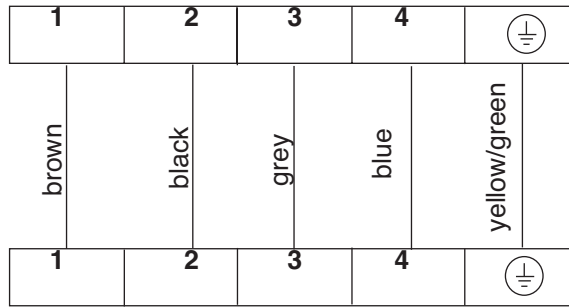

9. Notes

1. Any unauthorized modifications to the device shall not be covered by the warranty.
2. Liability for any injury or damage to property resulting from defects caused by sales, storage, transportation or unloading personnel shall rest with the person(s) causing such injury or damage to property.
3. We shall not accept liability for any damages caused by product defects resulting from improper installation by the user (including installation by any parties other than parties authorized by us, and any modifications following initial installation).
4. We shall not accept liability for any damages caused by product defects resulting from any maintenance work performed by the user (including maintenance work undertaken for the user by unauthorized third-parties).
5. We shall not accept liability for any damages caused by product defects resulting from undervoltage below 217 V ~ or overvoltage above 243 V ~, or resulting from force majeure.
6. We shall not accept liability for any damages caused by product defects resulting from improper operation by the user.
7. A damaged power cable must never be replaced by any other type of cable than the special power cable specified.
8. Pull out the power plug whenever the air conditioner is not in use.

- D** EG Konformitätserklärung
 GB EC Declaration of Conformity
 F Déclaration de Conformité CE
 NL EC Conformiteitsverklaring
 E Declaracion CE de Conformidad
 P Declaração de conformidade CE
 S EC Konformitetsförklaring
 FIN EC Yhdennukausilmoitus
 N EC Konfirmatsetserklæring
 RUS **EC** Заявление о конформности
 HR Dichiarazione di conformità CE
 RO Declarație de conformitate CE
 TR AT Uygunluk Deklarasyonu

Einhell®

- GR** EC Δήλωση περι της ανταπόκρισης
 I Dichiarazione di conformità CE
 DK EC Overensstemmelseserklæring
 CZ EU prohlášení o konformitě
 H EU Konformkijelentés
 SLO EU Izjava o skladnosti
 PL Oświadczenie o zgodności z normami Europejskiej Wspólnoty
 SK Vyhásenie EU o konformite



Split-Klimagerät SKA 3500 C+H

Der Unterzeichnende erklärt in Namen der Firma die Übereinstimmung des Produktes.

The undersigned declares in the name of the company that the product is in compliance with the following guidelines and standards.

Le soussigné déclare au nom de l'entreprise la conformité du produit avec les directives et normes suivantes.

De ondertekenaar verklaart in naam van de firma dat het product overeenstemt met de volgende richtlijnen en normen.

El abajo firmante declara, en el nombre de la empresa, la conformidad del producto con las directrices y normas siguientes.

O signatário declara em nome da firma a conformidade do produto com as seguintes directivas e normas.

Undertecknad förklarar i firmans namn att produkten överensstämmer med följande direktiv och standarder.

Allekirjoittanut ilmoittaa liikkeen nimissä, että tuote vastaa seuraavia direktiivejä ja standardeja:

Undertegnede erklærer på vegne av firmaet at produktet samsvarer med følgende direktiver og normer.

Подписавшийся подтверждает от имени фирмы что настоящее изделие соответствует требованиям следующих нормативных документов.

Az aláíró kijelenti, a cég nevében a termék megegyezését a következő irányvonalakkal és normákkal.

Subsemnatul declară în numele firmei că produsul corespunde următoarelor directive și standarde.

Imzalyan kişi, firma adına ürünüň aşagyda anılan ýönetmeliklere we normlara uýgun olduşgunu beýan eder.

Ev onðmati της εταιρείας δηλώνει ο υπογεγραμμένος την συμφωνία του προϊόντος προς τους ακόλουθους κανονισμούς και τα ακόλουθα πρότυπα.

Il sottoscritto dichiara a nome della ditta la conformità del prodotto con le direttive e le norme seguenti.

På firmaets vegne erklærer undertegnede, at produktet imødekommer kravene i følgende direktiver og normer.

Niže podepsani jmenem firmy prohlašuje, že výrobek odpovídá následujícím směrnici a normám.

Az aláíró kijelenti, a cég nevében a termék megegyezését a következő irányvonalakkal és normákkal.

Podpisani izjavljam v imenu podjetja, da je proizvod v skladnosti s sledečimi smernicami in standardi.

Niżej podpisany oświadcza w imieniu firmy, że produkt jest zgodny z następującymi wytycznymi i normami.

Podpisující závazně prohlašuje v mene firmy, že tento výrobek je v súlade s nasledovnými smernicami a normami.

- | | | | | |
|-------------------------------------|-------------------|--------------------------|---|---|
| <input type="checkbox"/> | 98/37/EG | <input type="checkbox"/> | 89/686/EWG | Hans Einhell AG
Wiesenweg 22
D-94405 Landau/lsar |
| <input checked="" type="checkbox"/> | 73/23/EWG | <input type="checkbox"/> | 87/404/EWG | |
| <input type="checkbox"/> | 97/23/EG | <input type="checkbox"/> | R&TTED 1999/5/EG | |
| <input checked="" type="checkbox"/> | 89/336/EWG | <input type="checkbox"/> | 2000/14/EG: L_{WM}.....dB(A); L_{WA}.....dB(A) | |
| <input type="checkbox"/> | 90/396/EWG | | | |

EN 60335-1+A1+A2+A11-A16; EN 60335-2-40+A1; EN 55014-1+A1+A2; EN 55014-2+A1; EN 61000-3-2;
EN 61000-3-11

Landau/lsar, den 12.02.2003

Brunhölzl
 Leiter Produkt-Management

Stoiber
 Produkt-Management

Archivierung / For archives: 2365322-43-4155050-E

GARANTIEURKUNDE

Auf das in der Anleitung bezeichnete Gerät geben wir 2 Jahre Garantie, für den Fall, dass unser Produkt mangelhaft sein sollte. Die 2-Jahres-Frist beginnt mit dem Gefahrenübergang oder der Übernahme des Gerätes durch den Kunden. Voraussetzung für die Geltendmachung der Garantie ist eine ordnungsgemäße Wartung entsprechend der Bedienungsanleitung sowie die bestimmungsgemäße Benutzung unseres Gerätes.

Selbstverständlich bleiben Ihnen die gesetzlichen Gewährleistungsrechte innerhalb dieser 2 Jahre erhalten. Die Garantie gilt für den Bereich der Bundesrepublik Deutschland oder der jeweiligen Länder des regionalen Hauptvertriebspartners als Ergänzung der lokal gültigen gesetzlichen Vorschriften. Bitte beachten Sie Ihren Ansprechpartner des regional zuständigen Kundendienstes oder die unten aufgeführte Serviceadresse.

ISC GmbH · International Service Center
Eschenstraße 6 · D-94405 Landau/Isar (Germany)
Info-Tel. 0180-5 120 509 · Telefax 0180-5 835 830
Service- und Infoserver: <http://www.isc-gmbh.info>

WARRANTY CERTIFICATE

The product described in these instructions comes with a 2 year warranty covering defects. This 2-year warranty period begins with the passing of risk or when the customer receives the product.

For warranty claims to be accepted, the product has to receive the correct maintenance and be put to the proper use as described in the operating instructions.

Your statutory rights of warranty are naturally unaffected during these 2 years.

This warranty applies in Germany, or in the respective country of the manufacturer's main regional sales partner, as a supplement to local regulations. Please note the details for contacting the customer service center responsible for your region or the service address listed below.

 Technical changes subject to change

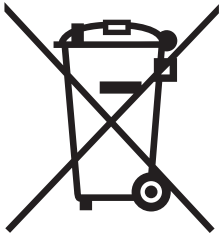

Ⓢ For EU countries only

Never place any electric tools in your household refuse.

To comply with European Directive 2002/96/EC concerning old electric and electronic equipment and its implementation in national laws, old electric tools have to be separated from other waste and disposed of in an environment-friendly fashion, e.g. by taking to a recycling depot.

Recycling alternative to the demand to return electrical devices:

As an alternative to returning the electrical device, the owner is obliged to cooperate in ensuring that the device is properly recycled if ownership is relinquished. This can also be done by handing over the used device to a returns center, which will dispose of it in accordance with national commercial and industrial waste management legislation. This does not apply to the accessories and auxiliary equipment without any electrical components which are included with the used device.



©

The reprinting or reproduction by any other means, in whole or in part, of documentation and papers accompanying products is permitted only with the express consent of ISC GmbH.

EH 01/2006

