

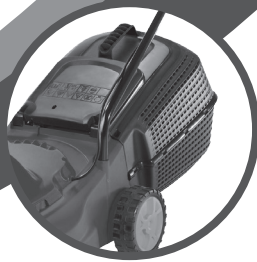

# GARDENLINE<sup>®</sup> ESSENTIALS 1000w Electric Lawn Mower

## User Guide



- 30cm cutting width
- 28 litre detachable grass collection box
- 3 adjustable cutting heights
- Integrated safety switch
- 8m cable

# Contents

---

- 03 Introduction
- 04 General Information & Safety Instructions
- 08 Assembly and Parts List
- 13 Features
- 14 Instructions
- 18 Other Useful Information
- 21 Warranty Card

## Packaging

The unit is supplied in packaging to prevent its contents being damaged in transit. This packaging is raw material and can therefore be reused or can be returned to the raw material system.



# Introduction

# 1

Congratulations on choosing to buy a Gardenline<sup>®</sup> Essentials product. By doing so you now have the assurance and peace of mind that comes with purchasing a product made by one of Europe's leading manufacturers.

All products brought to you by Gardenline<sup>®</sup> Essentials are manufactured to the highest standards of performance and safety, and, as part of our philosophy of customer service and satisfaction, are backed by our comprehensive 3 Year Warranty.

Great care has gone into the manufacture of this product and it should therefore provide you with years of good service when used properly. In the event of product failure within its intended use over the course of the first 3 years after date of purchase, we will remedy the problem as fast as possible once it has been brought to our attention. In the unlikely event of such an occurrence, or if you require any information about the product, please contact us via our helpline support services, details of which are to be found both in this manual and on the product itself.

We hope you will enjoy using your purchase for many years to come.

# General Information & Safety Instructions

# 2

## Safety information

### **General safety regulations for this electrical tool**

This equipment is not designed to be used by people (including children) with limited physical, sensory or mental capacities or those with no experience and/or knowledge unless they are supervised by a person who is responsible for their safety or they have received instructions from such a person in how to use the equipment safely.

Children must always be supervised in order to ensure that they do not play with the equipment.

### **Safety instructions for hand mower**

Before use, check the mains cable and extension cable for signs of damage and aging.

If the cable is damaged during operation, disconnect it immediately from the power supply.

Check the machine for signs of damage before use. If unusual vibrations occur during use, switch the machine off immediately and pull the plug. Check the cutters and clean them if necessary. If the machine continues to vibrate, switch it off, disconnect it from the mains supply and get it checked by a service engineer.

The machine must not be tipped whilst it is being started. Both hands must be on the handle when you start the machine.

### **WARNINGS**

Do not use the mower if the connection cable is damaged or worn.

Do not use a damaged cable to connect the machine to the mains supply and do not touch a damaged cable whilst it is connected to the mains. A damaged cable can result in contact with live parts.

Do not touch the cutters until the machine has been disconnected from the mains and the cutters have reached a complete standstill.

Keep extension cables away from the cutters. The cutters can damage the cables and result in contact with live parts.

Break the connection with the mains supply (in other words pull the plug out of the socket):

- whenever you leave the machine unattended;
- before releasing a blocked cutter;
- before inspecting or cleaning and before working on the machine;
- if a foreign body has been struck;
- whenever the machine starts to vibrate oddly.

Carefully read the instructions for how to operate the machine safely.

We recommend that the machine is only connected to a power supply protected by means of an earth-leakage circuit breaker (RCD) with a maximum trip current of 30 mA.

#### **Note**

a) Read the directions with due care. Familiarize yourself with the operator controls and proper operation of the machine.

b) Never allow children or other persons who are not familiar with the operating instructions to use the mower. Contact your local governmental agency for information regarding minimum age requirements for the user.

c) Never mow in the direct vicinity of persons - especially children - or animals.

d) Always keep in mind that the operator or user of the equipment is responsible for accidents involving other persons and/or their property.

#### **Preliminary measures**

a) Always wear sturdy, non-slip footwear and long trousers when mowing. Never mow barefoot or in sandals.

b) Check the ground on which the equipment will be used and remove all objects that could be caught up or violently flung out.

c) Before using the lawnmower, visually inspect it to ensure that the blade, mounting bolts and the entire cutting apparatus are in good working order (i.e. not worn out or damaged). To prevent any imbalance, replace worn out or damaged blades and mounting bolts as a set only (if applicable).

### **Handling**

- a) Only mow in broad daylight or in well-lit conditions.
- b) Do not use the machine on wet grass.
- c) Always maintain good footing on inclines.
- d) Only operate the machine at a walking pace.
- e) Always mow across hills i.e. never straight up or straight down.
- f) Be particularly careful when you change direction on a slope.
- g) Do not mow on overly steep inclines.
- h) Always be extra careful when turning the mower around and when pulling it towards you.
- i) Switch the mower off, pull the plug and wait until the cutters have reached a complete standstill if you need to tip the mower over, transport it over surfaces other than grass and if the mower has to be moved from and to the area you wish to mow.
- j) Never use the lawn mower if the guards are damaged or without the attached guards, e.g. deflectors and/or grass catching devices.
- k) Use the ON/OFF switch carefully as described in the manufacturer's instructions. Make sure that your feet are far enough away from the mower blade!
- l) The lawn mower should not be tilted when the motor is switch on unless it has to be raised for starting purposes. In this case, tilt it as little as absolutely necessary and only raise the side opposite to that of the user.
- m) Do not switch on the mower if you are positioned in front of the chute.

n) Never move your hands or feet toward or under any rotating parts. Keep clear of the chute opening at all times.

o) Never lift or carry a lawn mower with the engine running.

p) Switch off the motor and pull the power plug:

- before you dislodge any blockages or clogs in the chute.
- before carrying out any checks, cleaning, maintenance or other work on the lawn mower.
- if you have struck a foreign object. Examine the mower for signs of damage and carry out any necessary repairs before restarting and continuing to work with the mower.
- if the lawn mower begins to experience exceptionally strong vibrations, immediately switch it off and check it.

q) Switch off the mower and pull the plug whenever you leave the mower.

### **Maintenance and storage**

a) Make sure that all nuts, bolts and screws are tightened securely and that the machine is in safe working condition.

b) Allow the mower to cool before you put it into an enclosed area.

c) To avoid the risk of fire, keep the motor housing and ventilation slots clear of grass, leaves, oil and grease.

d) Routinely check the grass basket for signs of wear and impaired functionality.

e) For your own safety, have worn or damaged parts replaced without delay.

# Assembly & Parts List

# 3

## Layout (Fig. 1-2)

- 1 ON/OFF switch
- 2 Cable strain-relief clamp
- 3 Carry handle
- 4 Grass basket
- 5 Ejector flap
- 6 Power Cable
- 7 Top push bar
- 8 Bottom push bar
- 9 Fastening screws for bottom push bar
- 10 Fastening screws for top push bar
- 11 Cable clips
- 12 Grass box housing halves
- 13 Grass box handle

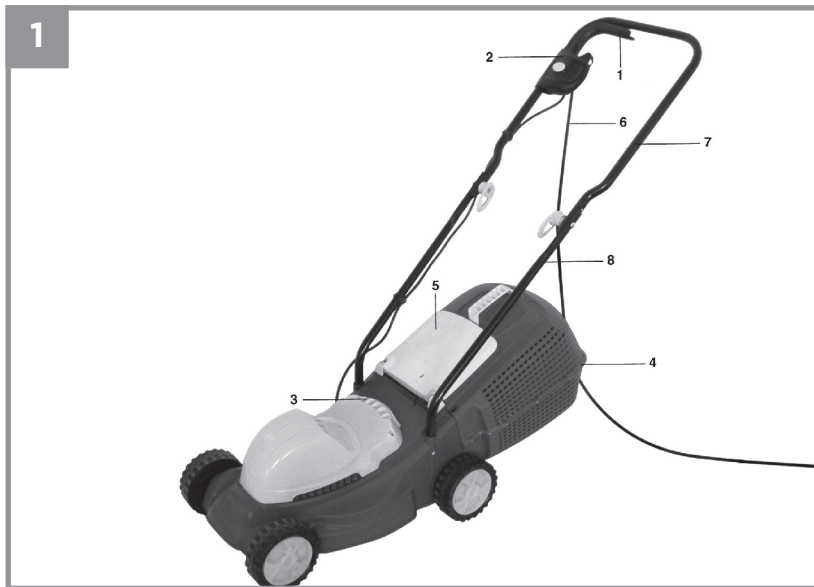

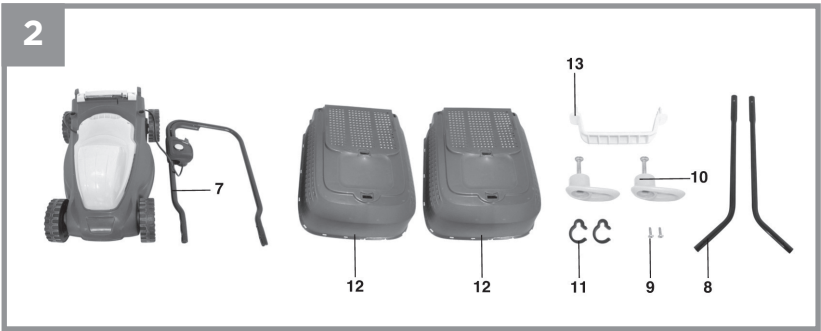

## Assembling the lawn mower

### Before starting the equipment

The lawn mower is delivered unassembled. The complete push bar and the grass collector must be assembled before using the lawn mower. Follow the operating instructions step-by-step and use the pictures provided as a visual guide to easily assemble the machine.

### Fitting the push bar (Fig. 3a to 3d)

Fit a bottom push bar (Fig. 3a / Item 8) into the opening provided for it (Fig. 3a) and secure it as shown in Fig. 3b with a screw (Fig. 3b / Item 9). Proceed in the same way on the other side. When you fit the top push bar you can decide the height of the push bar by selecting the appropriate fastening hole (Fig. 3c). Fasten the top push bar using either the holes L for a low position or H for a high position. Screw the top push bar to the bottom push bar as shown in Fig. 3d.

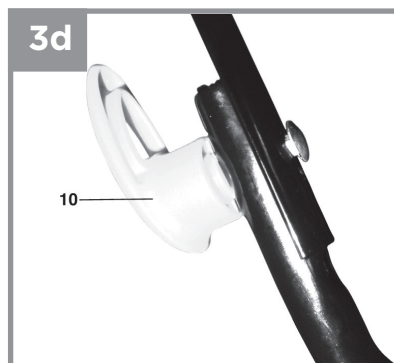
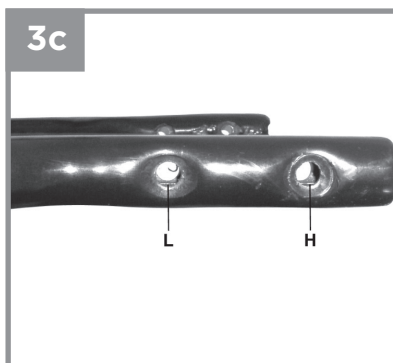
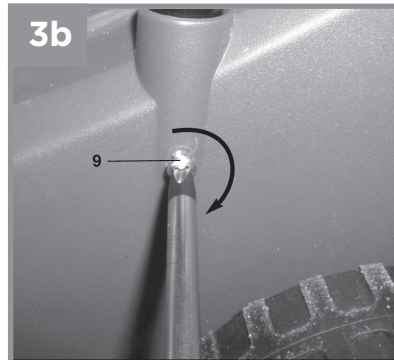



### Fitting the grass box (Fig. 4a to 4f)

Fit the two halves of the grass box together (Fig. 4a / Item 12). The two halves are identical. Ensure that all the plastic lugs engage correctly (Fig. 4b). Next push the grass box handle (Fig. 4c / Item 13) into the openings on the grass box. Check that the handle is secure and correctly positioned as shown in Fig. 4d. Before you fit the grass bag you must ensure that the motor is switched off and the blade is not rotating. The grass box must be attached to the two hooks on the mower (Fig. 4e / Item A). To do this, open the ejector flap with one hand (Fig. 4f / Item 5) and attach the grass box with the other hand as shown in Fig. 4f. The ejector flap is held against the grass box by a spring.

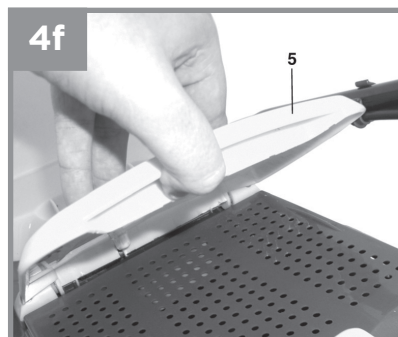
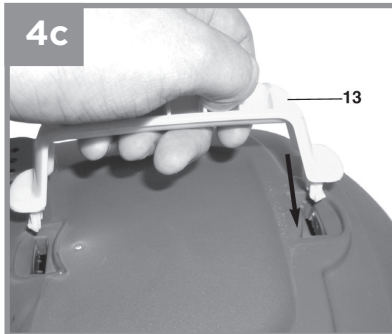
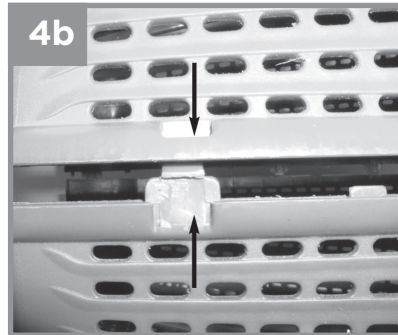
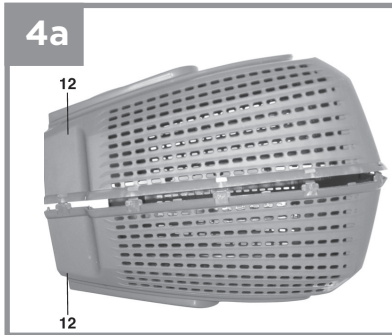

### Setting the cutting heights - Important!

Adjust the cutting height only when the engine is switched off and the power cable has been disconnected.

Before you begin to mow, check to ensure that the blade is not blunt and that none of the fasteners are damaged. To prevent any imbalance, replace blunt and/or damaged blades. To carry out this check, first switch off the motor and pull out the power plug.

The cutting height is adjusted as shown in Figs. 6a and 6b. To do this turn the hub cap clockwise to release the axle (Fig. 6a) and remove the hub cap with the screw and tire. The tires can now be fitted in position 1, 2 or 3 to suit the required cutting height. Fit all four tires at the same height so that the cutting blade runs parallel to the lawn.

Position	Cutting depth
1	60 mm
2	42.5 mm
3	25 mm

# Features

# 4

## Explanation of the warning signs on the equipment (see Fig. 8)

1 = Read the directions for use before operating the equipment.

2 = Wear ear guards and goggles.

3 = Keep all other persons away from the danger zone.

4 = Caution! -Sharp blades- Before carrying out any maintenance work or if you damage the cable, pull the plug out of the socket.

5 = Caution: The cutters continue to run after the motor is switched off.

6 = Do not expose the equipment to rain or moisture.

7 = Caution: Keep the power cable away from the cutters!

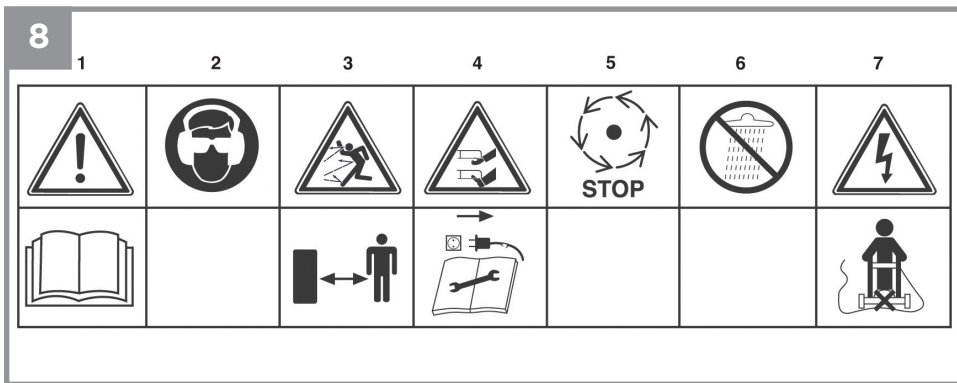

# Instructions

# 5

## Proper use

The lawn mower is designed for use in private gardens.

The machine is to be used only for its prescribed purpose. Any other use is deemed to be a case of misuse. The user / operator and not the manufacturer will be liable for any damage or injuries of any kind caused as a result of this.

Please note that our equipment has not been designed for use in commercial, trade or industrial applications. Our warranty will be voided if the machine is used in commercial, trade or industrial businesses or for equivalent purposes.

## Operation

Before you connect the equipment to the mains supply make sure that the data on the rating plate are identical to the mains data.

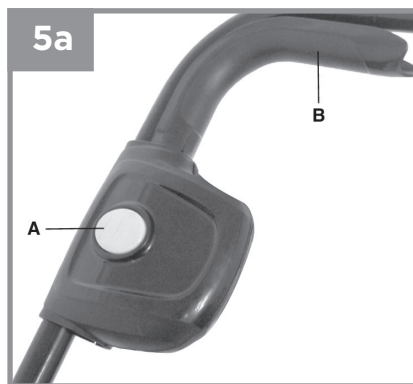

## Operation

### **Important!**

To prevent the machine switching on accidentally, the lawn mower is equipped with a safety lock-off (Fig. 5a/Item A) which must be pressed before the switching bar (Fig. 5a/Item B) can be activated. The lawn mower switches itself off when the switch is released.

Repeat this process several times so that you are sure that the machine functions properly. Before you perform any repair or maintenance work on the machine, ensure that the blade is not rotating and that the power supply is disconnected.

Repeat this process several times so that you are sure that the machine functions properly. Before you perform any repair or maintenance work on the machine, ensure that the blade is not rotating and that the power supply is disconnected.

### **Important!**

Never open the discharge flap if the grass box is being emptied and the motor is still running. The rotating blade can cause serious injuries.

Always secure the discharge flap and grass bag carefully. Always switch off the motor before you remove these items.

The safety distance between the blade casing and the user provided by the guide struts must be maintained at all times. Take special care when mowing and changing direction on embankments and slopes. Ensure that you have a secure surface to stand on, wear shoes with anti-slip soles that offer good grip, and long trousers. Always mow across the slope (not in up or down direction).

Do not use the mower on gradients exceeding 15° for safety reasons.

Take special care when moving backwards and pulling the lawn mower. Danger of stumbling.

## Information on correct mowing

We recommend that you mow in overlapping lines. Only mow with sharp, perfect blades so that the blades of grass do not fray, making the lawn turn yellow.

To achieve a good cut, guide the lawn mower in lines that are as straight as possible.

These lines should always overlap by a few centimeters so that you do not leave any strips. How often you should mow the lawn depends on how fast the lawn grows. During the main growth period (May - June), mow it twice a week, and once a week at other times. The cutting height should be between 4 and 6 cm and the growth before the next cut should be between 4 and 5 cm. If the lawn grows longer than this on occasion, do not make the mistake of cutting to normal length straight away since this will damage the lawn. Never cut the grass by more than half its height. Keep the underside of the mower casing clean and remove all grass deposits from it. Deposits make it more difficult to start the mower and also adversely affect the mowing quality and the grass discharge. On slopes mow across the slope (not in up or down direction). You can counteract the tendency of the mower to slide down the slope by setting it at an angle upwards. Select the cutting height to suit the actual length of the grass. Make several passes to ensure that you do not remove more than 4 cm of grass length in any one pass.

Switch off the motor before you carry out any inspections of the blade. Remember that the blade will continue to turn for a few seconds after the motor has been switched off. Never attempt to stop the blade.

Check regularly that the blade is correctly secured, in good condition and well ground. If not, grind or replace the blade. If the moving blade strikes an object, stop the mower and wait until the blade has come to a complete standstill. Then check the condition of the blade and the blade holder. If they are damaged, they must be replaced. Place the mains lead in loops on the ground in front of the socket. Mow away from the socket and cable and ensure that the mains lead is always on the section of lawn that you have already mowed so that you do not run over the mains lead with the mower. As soon as you see mown grass on the lawn whilst you are mowing, the grass bag will need emptying.

### **Important!**

Before you remove the grass bag switch off the motor and wait until the cutting tool reaches a standstill.

To remove the grass bag, raise the discharge flap with one hand and remove the grass bag using its handle with your other hand.

To maintain safety, the discharge flap will close when you remove the grass bag to seal the rear discharge opening. If any grass residues are caught in the opening, it is a good idea to pull the mower backwards around 1 m to make it easier to start the motor.

Do not remove grass cuttings in the mower casing or on the cutter by hand or with your feet. Instead use suitable tools such as a brush or broom. To ensure that it can collect the grass correctly the grass bag and in particular the net must be cleaned from the inside after use. Only attach the grass bag after switching off the motor and the cutting tool has reached a standstill. Raise the discharge flap with one hand and, holding the grass bag by its handle in your other hand, attach it from the top.

# Useful Information

# 6

## Cleaning, maintenance and ordering of spare parts

Always pull out the mains power plug before starting any cleaning work.

### Cleaning

- Keep all safety devices, air vents and the motor housing free of dirt and dust as far as possible. Wipe the equipment with a clean cloth or blow it with compressed air at low pressure.
- We recommend that you clean the device immediately each time you have finished using it.
- Clean the equipment regularly with a moist cloth and some soft soap. Do not use cleaning agents or solvents; these could attack the plastic parts of the equipment. Ensure that no water can seep into the device.

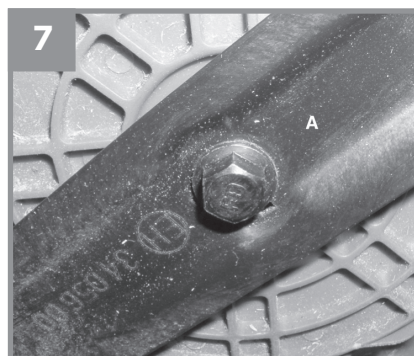
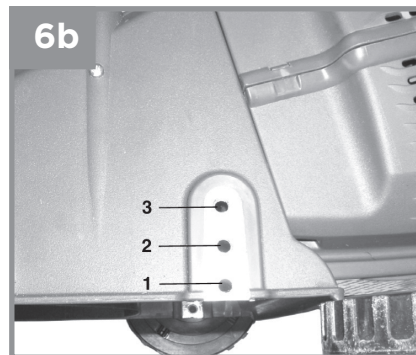
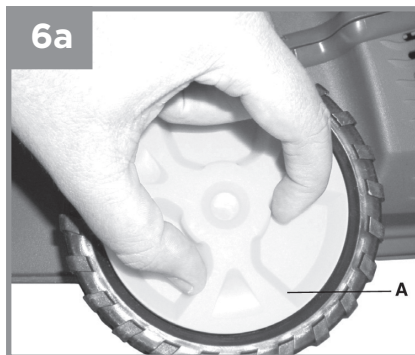



### **Replacing the blade**

For safety reasons, we recommend having the blade replaced by an authorized professional.

### **Important!**

Wear work gloves!

Only replace the blade with a genuine Einhell replacement blade, as this will ensure top performance and safety under all conditions.

Carry out the following steps to change the blade:

- Undo the fastening screw (Fig. 7).
- Remove the blade and replace with a new one.
- When fitting the blade, make sure it is installed in the right direction. The blade's air vanes must jut into the motor compartment.
- Then retighten the fastening screw. The tightening torque should be approx. 25 Nm.

### **Carbon brushes**

- In case of excessive sparking, have the carbon brushes checked only by a qualified electrician. Important! The carbon brushes should not be replaced by anyone but a qualified electrician.

### **Maintenance**

- There are no parts inside the equipment which require additional maintenance.

## **Ordering replacement parts**

Please quote the following data when ordering replacement parts:

- Type of machine
- Article number of the machine
- Identification number of the machine
- Replacement part number of the part required

For our latest prices and information please go to [www.isc-gmbh.info](http://www.isc-gmbh.info)

## Disposal and recycling

The unit is supplied in packaging to prevent its being damaged in transit. This packaging is raw material and can therefore be reused or can be returned to the raw material system.

The unit and its accessories are made of various types of material, such as metal and plastic. Defective components must be disposed of as special waste. Ask your dealer or your local council.

## Technical data

Voltage:	230 V ~ 50 Hz
Power input:	1000 watts
Motor speed:	3600 rpm
Cutting width:	30 cm
Cutting height adjustment:	25-60 mm; 3 levels
Volume of catch bag:	28 liters
L <sub>pA</sub> sound pressure level:	72,8 dB(A)
L <sub>WA</sub> sound power level:	96 dB(A)
Vibration at the handlebars a <sub>hv</sub> :	< 2,5 m/s <sup>2</sup>
Protection class	II/□

### Keep the noise emissions and vibrations to a minimum.

Only use appliances which are in perfect working order.

- Service and clean the appliance regularly.
- Adapt your working style to suit the appliance.
- Do not overload the appliance.
- Have the appliance serviced whenever necessary.
- Switch the appliance off when it is not in use.
- Wear protective gloves.

© Technical changes subject to change



### Declaration of Conformity

- |   |  |
|---|--|
| <p><b>(D)</b> erklärt folgende Konformität gemäß EU-Richtlinie und Normen für Artikel</p> <p><b>(E)</b> explains the following conformity according to EU directives and norms for the following product</p> <p><b>(F)</b> déclare la conformité suivante selon la directive CE et les normes concernant l'article</p> <p><b>(I)</b> dichiara la seguente conformità secondo la direttiva UE e le norme per l'articolo</p> <p><b>(NL)</b> verklaart de volgende overeenstemming conform EU richtlijn en normen voor het product</p> <p><b>(C)</b> declara la siguiente conformidad a tenor de la directiva y normas de la UE para el artículo</p> <p><b>(P)</b> declara a seguinte conformidade, de acordo com a directiva CE e normas para o artigo</p> <p><b>(B)</b> attesterer følgende overensstemmelse i medfør af EU-direktiv samt standarder for artikel</p> <p><b>(S)</b> förklarar följande överensstämmelse enl. EU-direktiv och standarder för artikeln</p> <p><b>(FI)</b> vakuuttaa, että tuote täyttää EU-direktiivin ja standardien vaatimukset</p> <p><b>(DK)</b> tænderab toote vastavust EL direktiivile ja standarditeile</p> <p><b>(CZ)</b> vydává následující prohlášení o shodě podle směrnice EU a norem pro výrobek</p> <p><b>(SK)</b> potvrduje sledečo skladnost s smernico EU in standardi za izdelek</p> <p><b>(HU)</b> vydáva nasledujúce prehlásenie o zhode podľa smernice EÚ a noriem pre výrobok</p> <p><b>(H)</b> a cikkekezh az EU-irányvonal és Normák szerint a következő konformitást jelenti ki</p> | <p><b>(PL)</b> deklaruje zgodność wymienionego poniżej artykułu z następującymi normami na podstawie dyrektywy WE.</p> <p><b>(BG)</b> декларира съответното съответствие съгласно Директива на ЕС и норми за артикул</p> <p><b>(LV)</b> paskaidro šādu atbilstību ES direktīvai un standartiem</p> <p><b>(LT)</b> apibūdina šį atitikimą EU reikalavimams ir prekės normoms</p> <p><b>(RO)</b> declară următoarea conformitate conform directivei UE și normelor pentru articolul</p> <p><b>(GR)</b> δηλώνει την ακόλουθη συμμόρφωση σύμφωνα με την Οδηγία ΕΚ και τα πρότυπα για το προϊόν</p> <p><b>(SL)</b> potvrdjuje sljedeću usklađenost prema smjernicama EU i normama za artikl</p> <p><b>(CZ)</b> potvrđuje sljedeću usklađenost prema smjernicama EU i normama za artikl</p> <p><b>(HU)</b> potvrdjuje sledeću usklađenost prema smernicama EZ i normama za artikl</p> <p><b>(SK)</b> следующим удостоверяется, что следующие продукты соответствуют директивам и нормам ЕС</p> <p><b>(HU)</b> проголошує про зазначену нижче відповідність виробу директивам та стандартам ЄС на виріб</p> <p><b>(SI)</b> ja izjavuva slednata soobraznost согласно EU-direktivata и нормите за артикли</p> <p><b>(IS)</b> Úrünü ile ilgili AB direktífferi ve normlari gereğince aşağıda açıklanan uygunluğú belirtir</p> <p><b>(NO)</b> erklærer følgende samsvar i henhold til EU-direktivet og standarder for artikkel</p> <p><b>(IS)</b> Lýsir uppfyllingu EU-reglna og annarra staðla vöru</p> |
|---|--|

### Electric Lawn Mower GLEM 1030 (Gardenline)

- |   |   |
|---|---|
| <input type="checkbox"/> 2009/105/EC            | <input checked="" type="checkbox"/> 2006/42/EC  |
| <input type="checkbox"/> 2006/95/EC             | <input type="checkbox"/> Annex IV<br>Notified Body:<br>Notified Body No.:<br>Reg. No.:  |
| <input type="checkbox"/> 2006/28/EC             | <input checked="" type="checkbox"/> 2000/14/EC_2005/88/EC   |
| <input type="checkbox"/> 2005/32/EC             | <input type="checkbox"/> Annex V  |
| <input checked="" type="checkbox"/> 2004/108/EC | <input checked="" type="checkbox"/> Annex VI<br>Noise: measured L <sub>WA</sub> = 93 dB (A); guaranteed L <sub>WA</sub> = 96 dB (A)<br>P = 1 KW; L/Ø = 30 cm<br>Notified Body: TÜV SÜD Industrie Service GmbH |
| <input type="checkbox"/> 2004/22/EC             | <input type="checkbox"/> 2004/26/EC<br>Emission No.:  |
| <input type="checkbox"/> 1999/5/EC              |   |
| <input type="checkbox"/> 97/23/EC               |   |
| <input type="checkbox"/> 90/396/EC              |   |
| <input type="checkbox"/> 89/686/EC_96/58/EC     |   |

Standard references: EN ISO 14121-1; EN 60335-1; EN 60335-2-77;  
EN 50366; EN 55014-1; EN 55014-2; EN 61000-3-2; EN 61000-3-3

Landau/Isar, den 23.10.2009

Weichselgartner/Gefner, Manager

Wang/Product-Management

First CE: 07  
Art.-No.: 34.002.47 I.-No.: 01019  
Subject to change without notice

Archive-File/Record: 3400240-32-4141750-07  
Documents registrar: Helmut Bauer  
Wiesenweg 22, D-94405 Landau/Isar



Ⓢ For EU countries only

Never place any electric tools in your household refuse.

To comply with European Directive 2002/96/EC concerning old electric and electronic equipment and its implementation in national laws, old electric tools have to be separated from other waste and disposed of in an environment-friendly fashion, e.g. by taking to a recycling depot.

Recycling alternative to the demand to return electrical devices:

As an alternative to returning the electrical device, the owner is obliged to cooperate in ensuring that the device is properly recycled if ownership is relinquished. This can also be done by handing over the used device to a returns center, which will dispose of it in accordance with national commercial and industrial waste management legislation. This does not apply to the accessories and auxiliary equipment without any electrical components which are included with the used device.

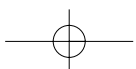
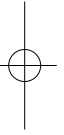
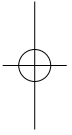
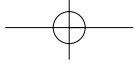

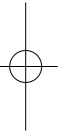
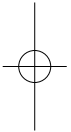
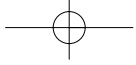

GLEM 1030

