

# MAINTENANCE



**WARNING!** BEFORE CLEANING OR CARRYING OUT ANY MAINTENANCE PROCEDURE, ENSURE THAT THE BATTERIES HAVE BEEN REMOVED.

## Cleaning

- Keep the ventilation slots of the tool clean at all times to ensure efficient operation.
- After each use, blow air through the tool housing to ensure it is free from all dust, dirt, etc. Build up of dust or dirt particles may cause the tool to overheat and shorten the life of the tool.
- If the housing of the tool requires cleaning, do not use solvents. Use of a cloth only is recommended.
- Never allow any liquid to get inside the tool, never immerse any part of the tool into liquid.

## Storage

- When not in use, the tool should be stored in a dry, frost free location, keep out of children's reach.

**Note:** Ozito Industries will not be responsible for any damage or injuries caused by repair of the tool by an unauthorised person or by mishandling.

# DESCRIPTION OF SYMBOLS

<b>V</b>	Volts	<b>Nm</b>	Newton metres
	Direct Current	<b>"</b>	inches
<b>/min</b>	Revolutions per minute	<b>n<sub>0</sub></b>	No load speed
	Regulatory Compliance Mark (RCM)	<b>mm</b>	Millimetres
	Do not dispose in general waste		Warning
	Read Instruction Manual		

# CARING FOR THE ENVIRONMENT



Power tools that are no longer usable should not be disposed of with household waste but in an environmentally friendly way. Please recycle where facilities exist. Check with your local council authority for recycling advice.



Recycling packaging reduces the need for landfill and raw materials. Reuse of recycled material decreases pollution in the environment. Please recycle packaging where facilities exist. Check with your local council authority for recycling advice.

# SPARE PARTS

Spare parts can be ordered from the Special Orders Desk at your local Bunnings Warehouse.

For further information, or any parts not listed here, visit [www.ozito.com.au](http://www.ozito.com.au) or contact Ozito Customer Service:

Australia 1800 069 486

New Zealand 0508 069 486

E-mail: [enquiries@ozito.com.au](mailto:enquiries@ozito.com.au)

# ELECTRICAL SAFETY

 **WARNING!** When using electric tools basic safety precautions should always be followed to reduce the risk of fire, electric shock and personal injury.

- Read the whole manual carefully and make sure you know how to switch the tool off in an emergency, before operating the tool. Save these instructions and other documents supplied with this tool for future reference.
- This appliance is not intended for use by persons (including children) with reduced physical, sensory or mental capabilities, or lack of experience and knowledge, unless they have been given supervision or instruction concerning use of the appliance by a person responsible for their safety. Children should be supervised to ensure that they do not play with the appliance.
- This appliance is compatible and only to be used with all batteries & chargers from the Ozito PXC range. Refer to the PXC battery and charger manuals for information regarding charging, use and storage.

-  **WARNING!** Always remove the battery from the tool:
- when the batteries are to be charged,
  - when the tool is left unattended,
  - when the tool is being checked, cleaned, or having maintenance work done,
  - when the tool is to be stored,
  - or if the tool vibrates abnormally.
- Do not combine different types of batteries or new and used batteries.
  - Do not use modified or damaged batteries.

# GENERAL POWER TOOL SAFETY WARNINGS

 **WARNING!** Read all safety warnings, instructions, illustrations and specifications provided with this power tool. Failure to follow all instructions listed below may result in electric shock, fire and/or serious injury.

Save all warnings and instructions for future reference.

The term "power tool" in the warnings refers to your mains-operated (corded) power tool or battery-operated (cordless) power tool.

## 1) Work area safety

- a) Keep work area clean and well lit. Cluttered or dark areas invite accidents.
- b) Do not operate power tools in explosive atmospheres, such as in the presence of flammable liquids, gases or dust. Power tools create sparks which may ignite the dust or fumes.
- c) Keep children and bystanders away while operating a power tool. Distractions can cause you to lose control.

## 2) Electrical safety

- a) Power tool plugs must match the outlet. Never modify the plug in any way. Do not use any adapter plugs with earthed (grounded) power tools. Unmodified plugs and matching outlets will reduce risk of electric shock.
- b) Avoid body contact with earthed or grounded surfaces, such as pipes, radiators, ranges and refrigerators. There is an increased risk of electric shock if your body is earthed or grounded.
- c) Do not expose power tools to rain or wet conditions. Water entering a power tool will increase the risk of electric shock.
- d) Do not abuse the cord. Never use the cord for carrying, pulling or unplugging the power tool. Keep cord away from heat, oil, sharp edges or moving parts. Damaged or entangled cords increase the risk of electric shock.
- e) When operating a power tool outdoors, use an extension cord suitable for outdoor use. Use of a cord suitable for outdoor use reduces the risk of electric shock.
- f) If operating a power tool in a damp location is unavoidable, use a residual current device (RCD) protected supply. Use of an RCD reduces the risk of electric shock.

## 3) Personal safety

- a) Stay alert, watch what you are doing and use common sense when operating a power tool. Do not use a power tool while you are tired or under the influence of drugs, alcohol or medication. A moment of inattention while operating power tools may result in serious personal injury.
- b) Use personal protective equipment. Always wear eye protection. Protective equipment such as a dust mask, non-skid safety shoes, hard hat or hearing protection used for appropriate conditions will reduce personal injuries.
- c) Prevent unintentional starting. Ensure the switch is in the off-position before connecting to power source and/or battery pack, picking up or carrying the tool. Carrying power tools with your finger on the switch or energising power tools that have the switch on invites accidents.
- d) Remove any adjusting key or wrench before turning the power tool on. A wrench or a key left attached to a rotating part of the power tool may result in personal injury.
- e) Do not overreach. Keep proper footing and balance at all times. This enables better control of the power tool in unexpected situations.
- f) Dress properly. Do not wear loose clothing or jewellery. Keep your hair and clothing away from moving parts. Loose clothes, jewellery or long hair can be caught in moving parts.
- g) If devices are provided for the connection of dust extraction and collection facilities, ensure these are connected and properly used. Use of dust collection can reduce dust-related hazards.
- h) Do not let familiarity gained from frequent use of tools allow you to become complacent and

ignore tool safety principles. A careless action can cause severe injury within a fraction of a second.

## 4) Power tool use and care

- a) Do not force the power tool. Use the correct power tool for your application. The correct power tool will do the job better and safer at the rate for which it was designed.
- b) Do not use the power tool if the switch does not turn it on and off. Any power tool that cannot be controlled with the switch is dangerous and must be repaired.
- c) Disconnect the plug from the power source and/or remove the battery pack, if detachable, from the power tool before making any adjustments, changing accessories, or storing power tools. Such preventive safety measures reduce the risk of starting the power tool accidentally.
- d) Store idle power tools out of the reach of children and do not allow persons unfamiliar with the power tool or these instructions to operate the power tool. Power tools are dangerous in the hands of untrained users.
- e) Maintain power tools and accessories. Check for misalignment or binding of moving parts, breakage of parts and any other condition that may affect the power tool's operation. If damaged, have the power tool repaired before use. Many accidents are caused by poorly maintained power tools.
- f) Keep cutting tools sharp and clean. Properly maintained cutting tools with sharp cutting edges are less likely to bind and are easier to control.
- g) Use the power tool, accessories and tool bits etc. in accordance with these instructions, taking into account the working conditions and the work to be performed. Use of the power tool for operations different from those intended could result in a hazardous situation.
- h) Keep handles and grasping surfaces dry, clean and free from oil and grease. Slippery handles and grasping surfaces do not allow for safe handling and control of the tool in unexpected situations.

## 5) Battery tool use and care

- a) Recharge only with the charger specified by the manufacturer. A charger that is suitable for one type of battery pack may create a risk of fire when used with another battery pack.
  - b) Use power tools only with specifically designated battery packs. Use of any other battery packs may create a risk of injury and fire.
  - c) When battery pack is not in use, keep it away from other metal objects, like paper clips, coins, keys, nails, screws or other small metal objects, that can make a connection from one terminal to another. Shorting the battery terminals together may cause burns or a fire.
  - d) Under abusive conditions, liquid may be ejected from the battery; avoid contact. If contact accidentally occurs, flush with water. If liquid contacts eyes, additionally seek medical help. Liquid ejected from the battery may cause irritation or burns.
  - e) Do not use a battery pack or tool that is damaged or modified. Damaged or modified batteries may exhibit unpredictable behaviour resulting in fire, explosion or risk of injury.
  - f) Do not expose a battery pack or tool to fire or excessive temperature. Exposure to fire or temperature above 130 °C may cause explosion.
  - g) Follow all charging instructions and do not charge the battery pack or tool outside the temperature range specified in the instructions. Charging improperly or at temperatures outside the specified range may damage the battery and increase the risk of fire.
- ## 6) Service
- a) Have your power tool serviced by a qualified repair person using only identical replacement parts. This will ensure that the safety of the power tool is maintained.
  - b) Never service damaged battery packs. Service of battery packs should only be performed by the manufacturer or authorized service providers.

# IMPACT WRENCH SAFETY WARNINGS

- Avoid using power tools and machines for long periods of time without breaks. Vibration from tools and machines can be transmitted into your hands and arms.
- Use auxiliary handle(s), if supplied with the tool. Loss of control can cause personal injury.
- Hold the power tool by insulated gripping surfaces, when performing an operation where the fastener may contact hidden wiring. Fasteners contacting a "live" wire may make exposed metal parts of the power tool "live" and could give the operator an electric shock. Before drilling into walls, ceilings etc, ensure that there are no concealed power cables or pipes in the cavity.
- Bits, sockets and tools get hot during operation, it's recommended to wear gloves when handling them.
- Do not overreach while operating the tool. Maintain a balanced working stance at all times.
- Do not use this tool for prolonged periods of time. Take regular breaks. Use gloves to provide extra cushioning in order to avoid any injury from the vibrations of the tool.
- Always use safety glasses.

- Do not point LED at eyes of persons or animals.

 **WARNING!** Some dust created by power sanding, sawing, grinding, drilling and other construction activities contains chemicals known to cause cancer, birth defects or other reproductive harm. Some examples of these chemicals are:

- Lead from lead-based paints
- Crystalline silica from bricks and cement and other masonry products
- Arsenic and chromium from chemically treated timber

Your risk from exposure to these chemicals varies, depending on how often you do this type of work. To reduce your exposure to these chemicals: work in a well ventilated area and work with approved safety equipment, such as dust masks that are specially designed to filter out microscopic particles.



18V BRUSHLESS

# 1/2" IMPACT WRENCH

## INSTRUCTION MANUAL

### SPECIFICATIONS

Voltage:	18V
No Load Speed:	0-2,900/min
Drive Shaft:	12.7mm (1/2")
Impact Rate:	0-3000bpm
Max. Torque:	230Nm
Weight:	1.2kg

[ozito.com.au](http://ozito.com.au)

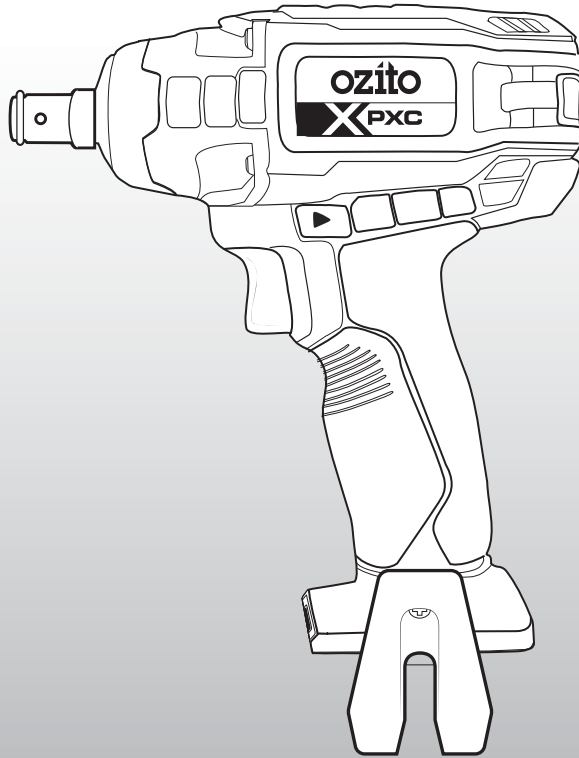

### STANDARD EQUIPMENT

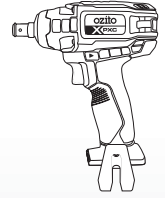

1/2" Brushless Impact Wrench

**5 YEAR**  
REPLACEMENT WARRANTY

**PXBWS-230**

## WARRANTY

IN ORDER TO MAKE A CLAIM UNDER THIS WARRANTY YOU MUST RETURN THE PRODUCT TO YOUR NEAREST BUNNINGS WAREHOUSE WITH YOUR BUNNINGS REGISTER RECEIPT. PRIOR TO RETURNING YOUR PRODUCT FOR WARRANTY PLEASE TELEPHONE OUR CUSTOMER SERVICE HELPLINE:

**Australia 1800 069 486**  
**New Zealand 0508 069 486**

TO ENSURE A SPEEDY RESPONSE PLEASE HAVE THE MODEL NUMBER AND DATE OF PURCHASE AVAILABLE. A CUSTOMER SERVICE REPRESENTATIVE WILL TAKE YOUR CALL AND ANSWER ANY QUESTIONS YOU MAY HAVE RELATING TO THE WARRANTY POLICY OR PROCEDURE.

### WARNING

**The following actions will result in the warranty being void.**

- If the tool has been operated on a supply voltage other than that specified on the tool.
- If the tool shows signs of damage or defects caused by or resulting from abuse, accidents or alterations.
- Failure to perform maintenance as set out within the instruction manual.
- If the tool is disassembled or tampered with in any way.

The benefits provided under this warranty are in addition to other rights and remedies which are available to you at law.

Our goods come with guarantees that cannot be excluded at law. You are entitled to a replacement or refund for a major failure and for compensation for any other reasonably foreseeable loss or damage. You are also entitled to have the goods repaired or replaced if the goods fail to be of acceptable quality and the failure does not amount to a major failure.

Generally you will be responsible for all costs associated with a claim under this warranty, however, where you have suffered any additional direct loss as a result of a defective product you may be able to claim such expenses by contacting our customer service helpline above.

### 5 YEAR REPLACEMENT WARRANTY

Your Product is guaranteed for a period of 60 months from the original date of purchase and is intended for DIY (Do It Yourself) use only. If a product is defective it will be replaced in accordance with the terms of this warranty. **Lithium Ion batteries and chargers are covered by a 36 month warranty** and are excluded from the warranty extension. Warranty excludes consumable parts.

# KNOW YOUR PRODUCT

## 1/2" BRUSHLESS IMPACT WRENCH

1. 1/2" Drive Shaft
2. Forward/Reverse Lever
3. Variable Speed Trigger
4. LED Light
5. Battery Seating
6. Belt Clip

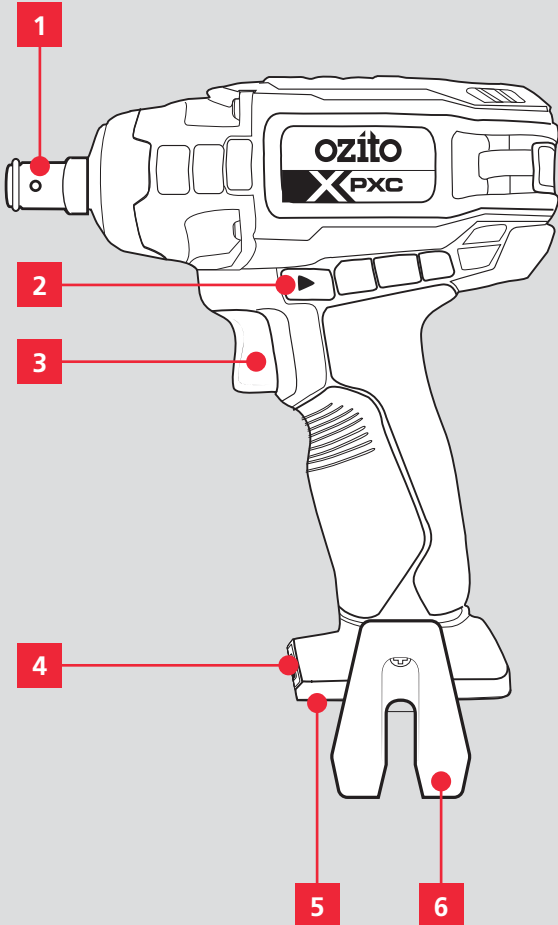

## BATTERY & CHARGER

This tool is compatible with all batteries & chargers from the Ozito PXC range.

### ONLINE MANUAL

Scan this QR Code with your mobile device to take you to the online manual.



# SETUP & PREPARATION

## 1. ASSEMBLY

**WARNING!** ENSURE THE TOOL IS SWITCHED OFF AND THE BATTERY IS REMOVED BEFORE PERFORMING ANY OF THE FOLLOWING TASKS.

### Inserting & Removing Drive Socket

1. Align the square end of a 1/2" drive socket with the drive shaft

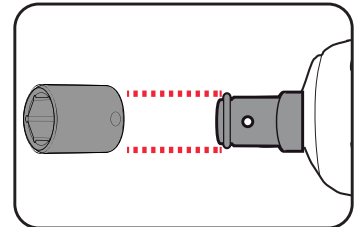

2. Push it on until it clicks into place.

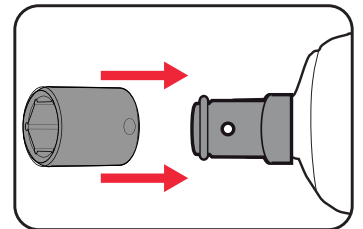

3. Pull the socket off the drive shaft to remove it.

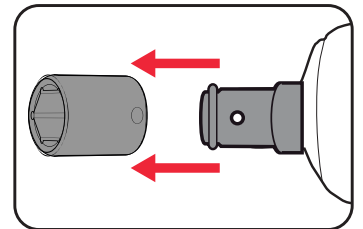

**WARNING!** DO NOT HANDLE ACCESSORIES WITHOUT GLOVES AS THEY CAN BECOME HOT AFTER USE, POTENTIALLY CAUSING PERSONAL INJURY.

**WARNING!** USE THE IMPACT WRENCH ONLY FOR TIGHTENING AND LOOSENING SCREWS AND NUTS. IF YOU WANT TO USE THE IMPACT WRENCH TO TIGHTEN SCREWS AND NUTS TO A SPECIFIC TORQUE, A TORQUE LIMIT MUST BE USED.

**5 YEAR**  
REPLACEMENT WARRANTY

# OPERATION

## 2. BATTERY FITMENT

### Inserting & Removing the Battery

1. Align the ribs of the battery with the recess at the base of the wrench handle and push in until it clicks into place.

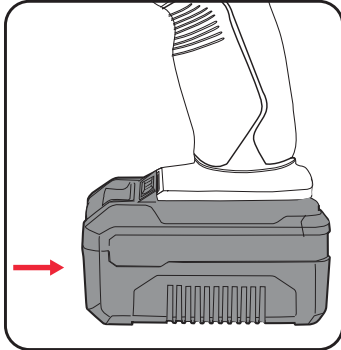

2. To remove, (a) press and hold the battery release button (b) release tab and then slide out.

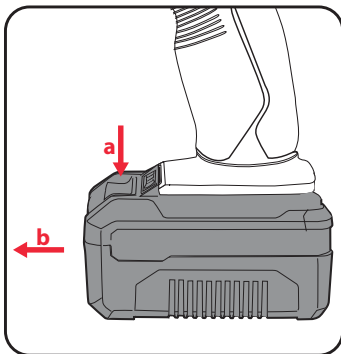

## 3. CONTROLS

### Switching The Tool On/Off

1. To start the wrench, squeeze the variable speed trigger.

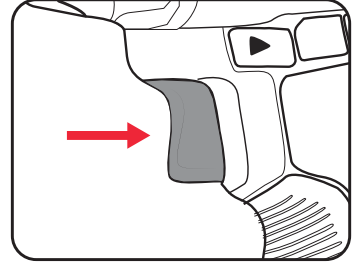

2. Release the variable speed trigger to stop the wrench.

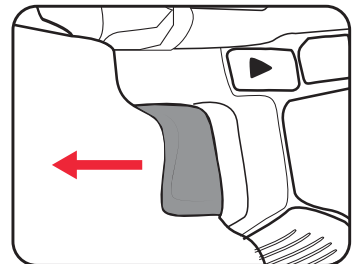

### Adjusting The Speed

1. Control the speed by adjusting the amount of pressure applied to the trigger.

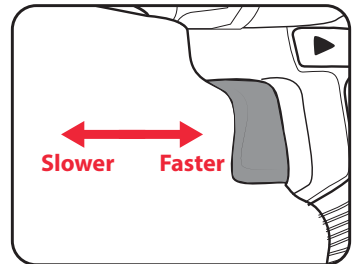

### Forward / Reverse Lever

1. To tighten and drive bolts, push the forward/reverse lever hard left.

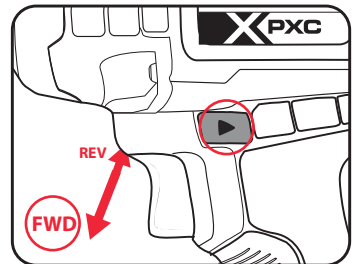

2. To loosen or remove bolts, push the forward/reverse lever hard right

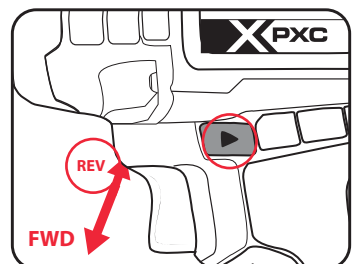

### NOTE

Push the lever into the centre position to lock the variable speed trigger and prevent accidental starting

# TROUBLESHOOTING

**WARNING!** ENSURE THE TOOL IS SWITCHED OFF AND THE BATTERY IS REMOVED BEFORE PERFORMING ANY OF THE FOLLOWING TASKS.

## 4. USAGE

### Driving Procedure

1. Depress and release the on/off trigger to ensure it is not locked.

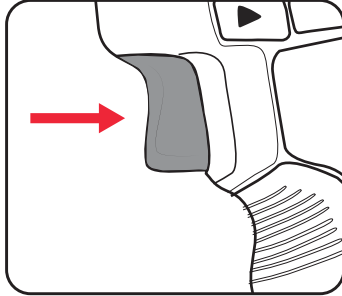

2. Check the forward/reverse lever is on desired setting.

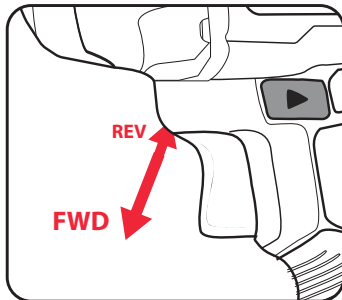

3. Ensure the work piece is secured to stop it turning whilst driving.

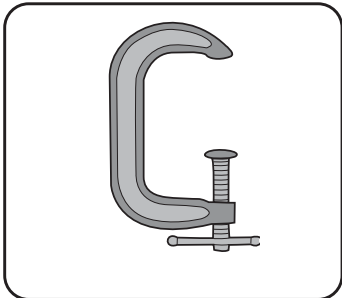

4. Hold the socket firmly against the bolt to stop it slipping.

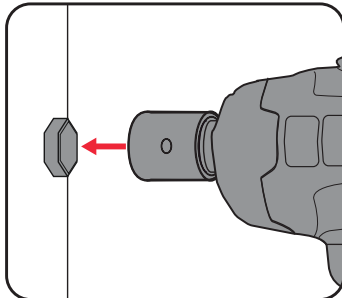

5. Slowly increase pressure on trigger to appropriate torque for circumstances until bolt is tightened.

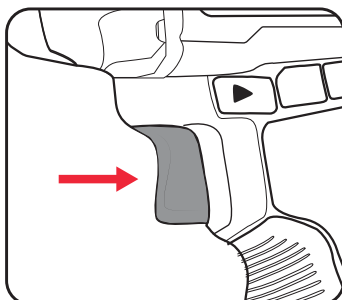

### LED lights do not illuminate on charger

Check the charging adaptor is securely plugged into the wall outlet.  
Check the battery is firmly connected to the charging cradle.

Check that the charging jack is securely connected to the charging cradle.

### The battery has a short run time

Ensure the battery is properly charged. It will take 4-5 charging cycles before the battery reaches optimum charge and run time. On the initial charge, the battery requires 5 hours of charging. Subsequent charging only requires 3-5 hours.

### Variable speed trigger is locked

Ensure that the forward / reverse lever is in the correct position; pressed left for forwards direction, pressed right for backwards direction. If it is in between the two settings the variable speed trigger will be locked.

### The Brushless Impact Wrench is stripping the bolt head

Ensure the correct size socket is being used and placed over the bolt head securely before attempting to fasten or loosen.