

# ozito

## DRILL BIT SHARPENER

95W

### INSTRUCTION MANUAL

#### SPECIFICATIONS

Voltage:	220-240V ~ 50Hz
Input Power:	95W
No Load Speed:	1,350/min
Working Capacity:	3mm-12mm (1/8"-15/32")
Weight:	1kg

ozito.com.au

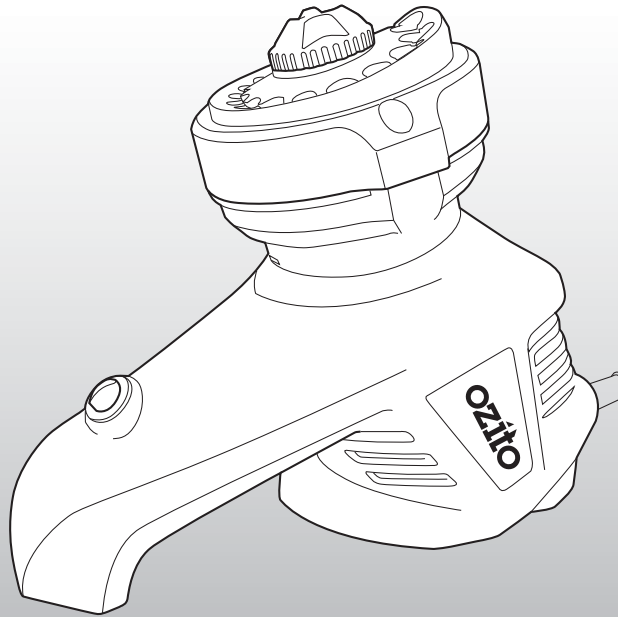

#### WHAT'S IN THE BOX

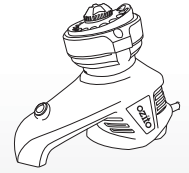

Drill Bit Sharpener

**3** YEAR REPLACEMENT WARRANTY

**DBS-095**

## WARRANTY

IN ORDER TO MAKE A CLAIM UNDER THIS WARRANTY YOU MUST RETURN THE PRODUCT TO YOUR NEAREST BUNNINGS WAREHOUSE WITH YOUR BUNNINGS REGISTER RECEIPT. PRIOR TO RETURNING YOUR PRODUCT FOR WARRANTY PLEASE TELEPHONE OUR CUSTOMER SERVICE HELPLINE:

**Australia 1800 069 486**

**New Zealand 0508 069 486**

TO ENSURE A SPEEDY RESPONSE PLEASE HAVE THE MODEL NUMBER AND DATE OF PURCHASE AVAILABLE. A CUSTOMER SERVICE REPRESENTATIVE WILL TAKE YOUR CALL AND ANSWER ANY QUESTIONS YOU MAY HAVE RELATING TO THE WARRANTY POLICY OR PROCEDURE.

The benefits provided under this warranty are in addition to other rights and remedies which are available to you at law.

Our goods come with guarantees that cannot be excluded at law. You are entitled to a replacement or refund for a major failure and for compensation for any other reasonably foreseeable loss or damage. You are also entitled to have the goods repaired or replaced if the goods fail to be of acceptable quality and the failure does not amount to a major failure.

Generally you will be responsible for all costs associated with a claim under this warranty, however, where you have suffered any additional direct loss as a result of a defective product you may be able to claim such expenses by contacting our customer service helpline above.

### 3 YEAR REPLACEMENT WARRANTY

Your product is guaranteed for a period of **36 months from the original date of purchase** and is intended for DIY (Do It Yourself) use only. If a product is defective it will be replaced in accordance with the terms of this warranty. Warranty excludes consumable parts, for example: carbon brushes.

### WARNING

**The following actions will result in the warranty being void.**

- If the tool has been operated on a supply voltage other than that specified on the tool.
- If the tool shows signs of damage or defects caused by or resulting from abuse, accidents or alterations.
- Failure to perform maintenance as set out within the instruction manual.
- If the tool is disassembled or tampered with in any way.
- Professional, industrial or high frequency use.

# KNOW YOUR PRODUCT

## DRILL BIT SHARPENER

- 1 On/off Switch
- 2 Drill Bit Template Guide
- 3 Grinding Stone Adjustment Dial

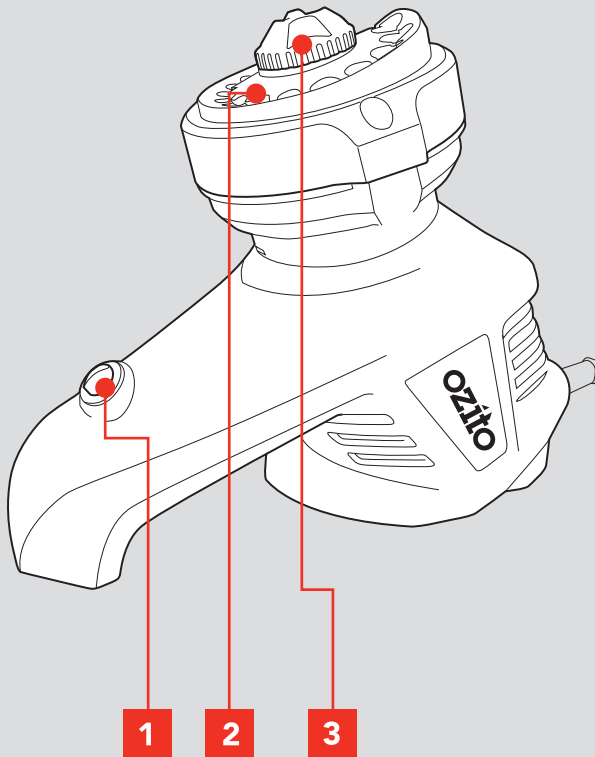

### ONLINE MANUAL

Scan this QR Code with your mobile device to take you to the online manual.



# SETUP & PREPARATION

## 1. ADJUSTING THE GRINDING STONE

The tool is recommended for use with a residual current device with a rated residual current of 30mA or less.

1. Lower the grinding stone as far as possible by turning the grinding stone adjustment knob anticlockwise.

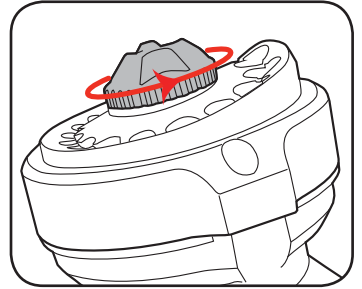

2. Insert the drill bit into the same sized template guide hole.

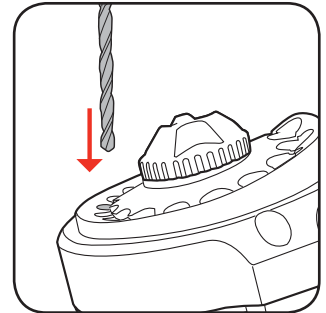

3. Turn the drill bit sharpener on.

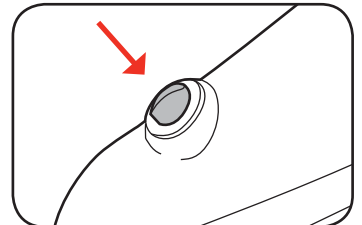

4. Raise the grinding stone by turning the grinding stone adjustment knob clockwise until it can be heard touching the drill bit.

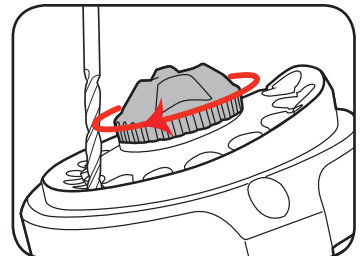

**NOTE:** RAISING THE GRINDING STONE WILL PRODUCE AN AGGRESSIVE GRIND AND ROUGH EDGE. LOWERING THE GRINDING STONE WILL PRODUCE A FINER GROUND EDGE.

**3** YEAR REPLACEMENT WARRANTY

# OPERATION

## 2. CONTROLS

### Turning on/off

1. To turn on, press the on/off switch into the "I" position.
2. To turn off, press the on/off switch into the "O" position.

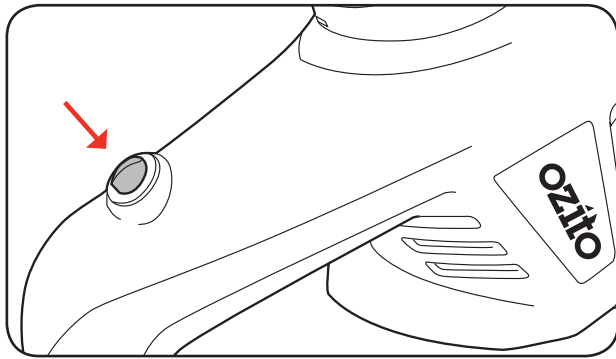

### Grinding Stone Adjustment Dial

Turn the grinding stone adjustment dial anti-clockwise to lower the grinding stone.

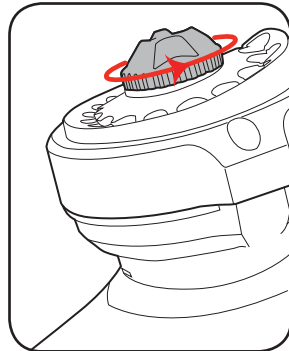

Turn the grinding stone adjustment dial clockwise to raise the grinding stone.

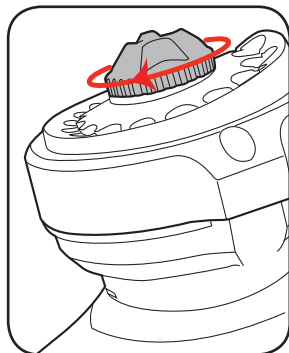

## 3. SHARPENING PROCEDURE

1. Ensure the drill bit that requires sharpening is in the smallest template guide it fits.

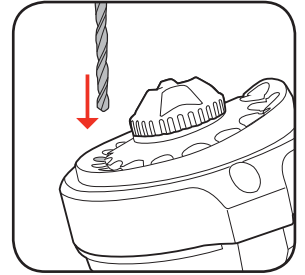

2. Turn the drill bit sharpener on.

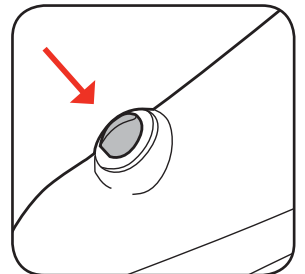

3. Press down slightly on the drill bit while rotating the bit back and forth between your fingers.

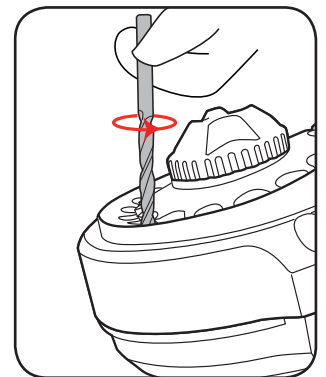

4. Turn the drill bit sharpener off, remove the drill bit and examine the cutting edge is sharp.

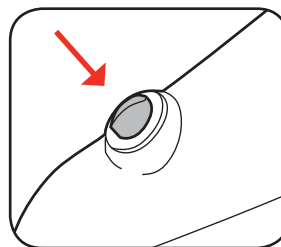

5. Rotate the drill bit 180° and reinsert into the drill bit sharpener.

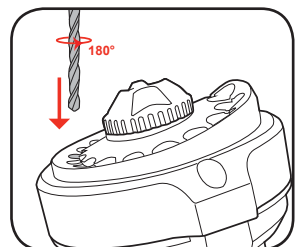

6. Repeat steps 2-5. Ensure that both sides of the drill bit are sharpened for the same amount of time, using the same amount of pressure.

## 4. MAINTENANCE

### Changing the Grinding Stone

The grinding stone will need to be changed when grooves or ridges mar the evenness of the grinding surface.

1. Raise the grinding stone.

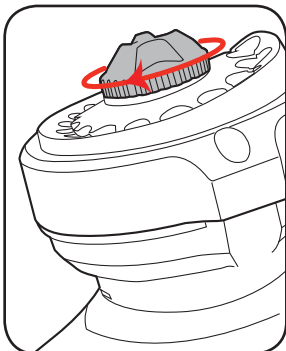

2. Loosen the two screws on the top of the drill bit sharpener.

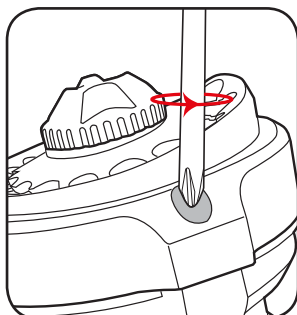

3. Remove the Index head assembly.

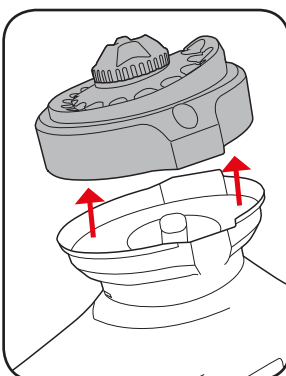

4. Remove the stone assembly, ensuring the spring stays in place.

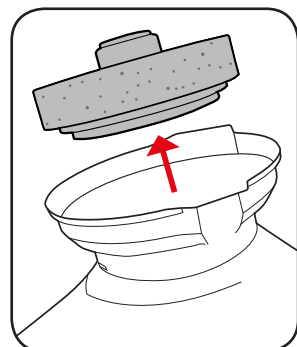

5. Insert a new grinding wheel assembly onto the drive shaft. Rotate until it locates into place.

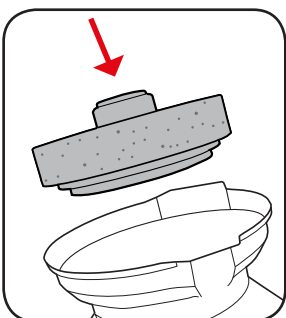

6. Replace the index head assembly, fasten by tightening the two screws.

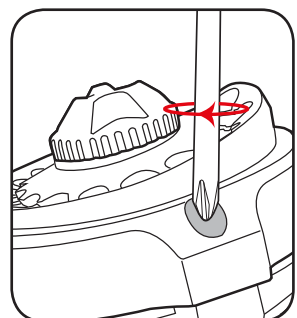

# MAINTENANCE

- Keep the ventilation vents of the drill bit sharpener clean at all times, if possible, prevent foreign matter from entering the vents.
- After each use, blow air through the drill bit sharpener housing to ensure it is free from all dust particles which may build up. Build up of dust particles may cause the drill bit sharpener to overheat and fail.
- If the enclosure of the drill bit sharpener requires cleaning, do not use solvents but a moist soft cloth only. Never let any liquid get inside the drill bit sharpener; never immerse any part of the drill bit sharpener into a liquid.

## Carbon Brushes



When the carbon brushes wear out, the drill bit sharpener will spark and/or stop. Discontinue use as soon as this happens. They should be replaced prior to recommencing use of the drill bit sharpener. Carbon brushes are a wearing component of the drill bit sharpener therefore not covered under warranty. Continuing to use the drill bit sharpener when carbon brushes need to be replaced may cause permanent

damage to the drill bit sharpener. Carbon brushes will wear out after many uses but when the carbon brushes need to be replaced, take the drill bit sharpener to an electrician or a power tool repairer for a quick and low cost replacement. Always replace both carbon brushes at the same time.

*Note: Ozito Industries will not be responsible for any damage or injuries caused by the repair of the drill bit sharpener by an unauthorised person or by mishandling of the drill bit sharpener.*

# TROUBLESHOOTING

## Sparking visible through the housing air vents

A small amount of sparking may be visible through the housing vents. This is normal and does not indicate a problem.



## Excessive sparking visible through the housing air vents and/or the drill bit sharpener failing to operate

May indicate the carbon brushes have worn out and need to be replaced. Carbon brushes should only be replaced by a qualified electrician or power tool repairer.

## The tip of my drill bit is turning blue

This is because the drill bit is overheating. You will need to reduce the amount of pressure and sharpening time, cool the drill bit in water in between sharpening.

## One edge of my drill bit is longer than the other (the centre point is therefore not centred)

One side of the drill bit has been sharpened for longer than the other. You will need to sharpen the shorter side for more time and ensure that both sides are always sharpened for the same amount of time using the same amount of pressure.

## My drill bit is broken (rather than blunt)

The DBS-3100 is not suitable for sharpening broken drill bits. A drill bit in this condition will take a substantial amount of time to sharpen. Rough the drill bit into shape first using a bench grinder.

## The motor turns on but the grinding stone does not spin

For this to happen the grinding stone assembly may not be aligned with the flats on the shaft. Check that the grinding stone assembly is aligned with the flats on the shaft (see maintenance section).

## The drill bit sharpener does not start

The grinder stone may not be moving freely. Turn the grinding stone adjustment knob anticlockwise to move the grinding stone downwards, this will allow the grinding stone to turn freely.

# DESCRIPTION OF SYMBOLS

V	Volts	Hz	Hertz
~	Alternating current	W	Watts
/min	Revolutions or reciprocation per minute	n <sub>o</sub>	No load speed
	Double insulated		Regulator compliance mark
	Warning		

# SPARE PARTS

Spare parts can be ordered from the Special Orders Desk at your local Bunnings Warehouse.

For further information, or any parts not listed here, visit

[www.ozito.com.au](http://www.ozito.com.au) or contact Ozito Customer Service:

**Australia 1800 069 486**

**New Zealand 0508 069 486**

**E-mail: [enquiries@ozito.com.au](mailto:enquiries@ozito.com.au)**

# CARING FOR THE ENVIRONMENT



Power tools that are no longer usable should not be disposed of with household waste but in an environmentally friendly way. Please recycle where facilities exist. Check with your local council authority for recycling advice.



Recycling packaging reduces the need for landfill and raw materials. Reuse of recycled material decreases pollution in the environment. Please recycle packaging where facilities exist. Check with your local council authority for recycling advice.



# ELECTRICAL SAFETY

The electric motor has been designed for 230V and 240V only. Always check that the power supply corresponds to the voltage on the rating plate.

Note: The supply of 230V and 240V on Ozito tools are interchangeable for Australia and New Zealand.



This tool is double insulated; therefore no earth wire is required.

If the supply cord is damaged, it must be replaced by an electrician or a power tool repairer in order to avoid a hazard.

Note: Double insulation does not take the place of normal safety precautions when operating this tool. The insulation system is for added protection against injury resulting from a possible electrical insulation failure within the tool.

Using an Extension Lead

Always use an approved extension lead suitable for the power input of this tool. Before use, inspect the extension lead for signs of damage, wear and ageing. Replace the extension lead if damaged or defective.

When using an extension lead on a reel, always unwind the lead completely. Use of an extension lead not suitable for the power input of the tool or which is damaged or defective may result in a risk of fire and electric shock.



# GENERAL POWER TOOL SAFETY WARNINGS



**WARNING!** Read all safety warnings and all instructions. Failure to follow the warnings and instructions may result in electric shock, fire and/or serious injury.

Save all warnings and instructions for future reference. The term "power tool" in the warnings refers to your mains-operated (corded) power tool or battery-operated (cordless) power tool.

## 1. Work area safety

- Keep work area clean and well lit. Cluttered or dark areas invite accidents.
- Do not operate power tools in explosive atmospheres, such as in the presence of flammable liquids, gases or dust. Power tools create sparks which may ignite the dust or fumes.
- Keep children and bystanders away while operating a power tool. Distractions can cause you to lose control.

## 2. Electrical safety

- Power tool plugs must match the outlet. Never modify the plug in any way. Do not use any adapter plugs with earthed (grounded) power tools. Unmodified plugs and matching outlets will reduce risk of electric shock.
- Avoid body contact with earthed or grounded surfaces, such as pipes, radiators, ranges and refrigerators. There is an increased risk of electric shock if your body is earthed or grounded.
- Do not expose power tools to rain or wet conditions. Water entering a power tool will increase the risk of electric shock.
- Do not abuse the cord. Never use the cord for carrying, pulling or unplugging the power tool. Keep cord away from heat, oil, sharp edges or moving parts. Damaged or entangled cords increase the risk of electric shock.
- When operating a power tool outdoors, use an extension cord suitable for outdoor use. Use of a cord suitable for outdoor use reduces the risk of electric shock.
- If operating a power tool in a damp location is unavoidable, use a residual current device (RCD) protected supply. Use of an RCD reduces the risk of electric shock.

## 3. Personal safety

- Stay alert, watch what you are doing and use common sense when operating a power tool. Do not use a power tool while you are tired or under the influence of drugs, alcohol or medication. A moment of inattention while operating power tools may result in serious personal injury.
- Use personal protective equipment. Always wear eye protection. Protective equipment such as dust mask, non-skid safety shoes, hard hat, or hearing protection used for appropriate conditions will reduce personal injuries.
- Prevent unintentional starting. Ensure the switch is in the off-position before connecting to power source and/or battery pack, picking up or carrying the tool. Carrying power tools with your finger on the switch or energising power tools that have the switch on invites accidents.

- Remove any adjusting key or wrench before turning the power tool on. A wrench or a key left attached to a rotating part of the power tool may result in personal injury.
- Do not overreach. Keep proper footing and balance at all times. This enables better control of the power tool in unexpected situations.
- Dress properly. Do not wear loose clothing or jewellery. Keep your hair, clothing and gloves away from moving parts. Loose clothes, jewellery or long hair can be caught in moving parts.
- If devices are provided for the connection of dust extraction and collection facilities, ensure these are connected and properly used. Use of dust collection can reduce dust-related hazards.
- Do not let familiarity gained from frequent use of tools allow you to become complacent and ignore tool safety principles. A careless action can cause severe injury within a fraction of a second.

## 4. Power tool use and care

- Do not force the power tool. Use the correct power tool for your application. The correct power tool will do the job better and safer at the rate for which it was designed.
- Do not use the power tool if the switch does not turn it on and off. Any power tool that cannot be controlled with the switch is dangerous and must be repaired.
- Disconnect the plug from the power source and/or the battery pack from the power tool before making any adjustments, changing accessories, or storing power tools. Such preventive safety measures reduce the risk of starting the power tool accidentally.
- Store idle power tools out of the reach of children and do not allow persons unfamiliar with the power tool or these instructions to operate the power tool. Power tools are dangerous in the hands of untrained users.
- Maintain power tools. Check for misalignment or binding of moving parts, breakage of parts and any other condition that may affect the power tool's operation. If damaged, have the power tool repaired before use. Many accidents are caused by poorly maintained power tools.
- Keep cutting tools sharp and clean. Properly maintained cutting tools with sharp cutting edges are less likely to bind and are easier to control.
- Use the power tool, accessories and tool bits etc. in accordance with these instructions, taking into account the working conditions and the work to be performed. Use of the power tool for operations different from those intended could result in a hazardous situation.
- Keep handles and grasping surfaces dry, clean and free from oil and grease. Slippery handles and grasping surfaces do not allow for safe handling and control of the tool in unexpected situations.

## 5. Service

- Have your power tool serviced by a qualified repair person using only identical replacement parts. This will ensure that the safety of the power tool is maintained.



# DRILL BIT SHARPENER SAFETY WARNINGS

This appliance is not intended for use by persons (including children) with reduced physical, sensory or mental capabilities, or lack of experience and knowledge, unless they have been given supervision or instruction concerning use of the appliance by a person responsible for their safety.

Recommendations for the use of a residual current device with a rated residual current of 30mA or less.

This appliance is not intended for use by young or infirm persons unless supervised by a responsible person to ensure that they can use the appliance safely.

Young children should be supervised to ensure that they do not play with the appliance.

- Always wear eye, ear and breathing protection.
- Never operate the drill bit sharpener with cracked or damaged grinding stones. Always replace cracked or damaged grinding stones immediately.
- Always disconnect the drill bit sharpener from the power supply prior to making any adjustments.
- Always use safety equipment including earmuffs, goggles, gloves, hat and clothing when operating the drill bit sharpener.
- Check and ensure that all the fastening screws, bolts and nuts are securely tightened prior to operating the drill bit sharpener.
- Never use an object to slow or stop the grinding stone whilst in motion.
- Ensure the eye shields and tool rests are properly adjusted.
- Always use the eye shields and tool rests.
- Don't use grinding wheels for cutting purposes.
- Ensure the drill bit sharpener speed doesn't exceed the operating speed marked on replacement grinding stones.
- Wear protective glasses.
- Do not use damaged or misshaped stones.
- The adjustment of the spark arrestor shall be made frequently, so as to compensate the wear of the stone, keeping the distance between the guard and the stone as small as possible, but in any case not greater than 2mm.