

SLIDING COMPOUND MITRE SAW & STAND

210mm (8¼")

ORIGINAL INSTRUCTIONS

STAND ASSEMBLY

STAND

- | | |
|------------------------------|-----------------------------|
| 1 Short Upper Support - 2 pc | 4 Long Lower Support - 2 pc |
| 2 Short Lower Support - 2 pc | 5 Upper Leg - 4 pc |
| 3 Long Upper Support - 2 pc | 6 Lower Leg - 4 pc |

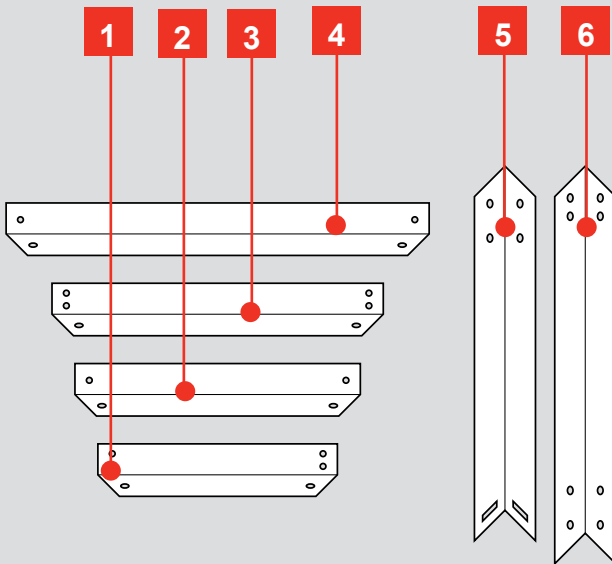

FASTENERS

- | | |
|------------------------|--|
| 7 Bolt Small - 36 pc | 11 Bolt Large with Rubber Stopper - 4 pc |
| 8 Washer Small - 36 pc | 12 Saw Mounting Bolts - 4 pc |
| 9 Nut Small - 36 pc | |
| 10 Rubber Foot - 4 pc | |

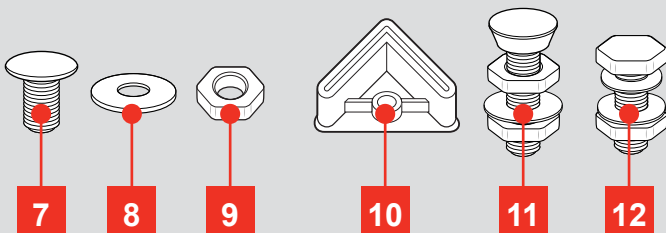

ASSEMBLY OF STAND

The stand is constructed by assembling each half of the structure and then joining them together.

- 1 Remove the stand components from the box and group matching pieces together. Check that you have all the contents listed to the left.

Note: All upper members can be identified by the 2 holes very close together.

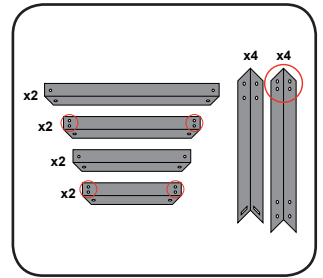

- 2 Lay two upper and lower legs on the ground aligning 2 of the bolt holes, parallel to each other. The upper leg sits outside the lower leg.

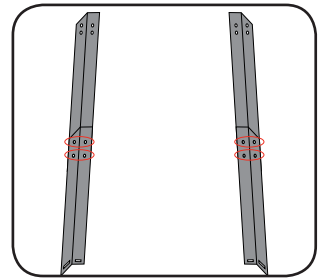

- 3 Place one long lower support in between the legs and align the bolt holes. The side support should have its lip on the high side (facing up) and should sit inside the legs. Ensure the lip with the lengthened bolt holes is facing upwards.

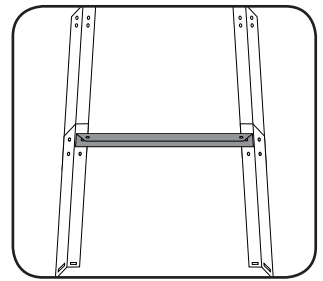

- 4 Once aligned, insert small bolts into the 2 aligned holes at both sides of the lower support. Insert the bolt from the outside and screw a small washer and nut onto each bolt to secure (only hand tight at this initial stage).

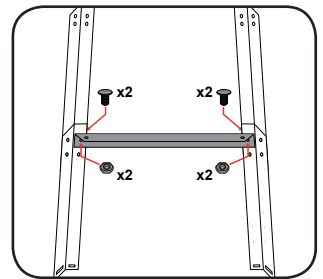

- 5 Place one long upper support on the **outside** of the legs at the top (This will ensure the mounting holes will align correctly once assembled). Insert a bolt from the outside into the 2 aligned holes at either side of the upper support and hand tighten a small washer and nut onto each.

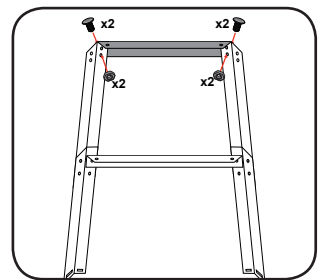

- 6 At this stage your frame should look like this.

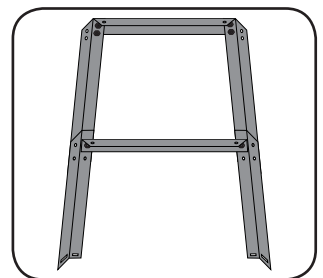

- 7 Align one short lower support inside the legs at the same height as the long lower support. Ensure that the lip of the side support is facing up. Insert 2 small bolts in the aligned holes from the outside and attaching a small washer and nut (only hand tight at this initial stage).

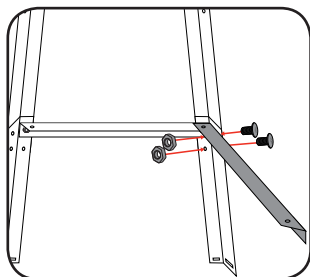

- 8 On the same side as Step 7, assemble one short upper support to the top of the upper leg using 2 small bolts, washers and nuts. One half of the frame is now complete.

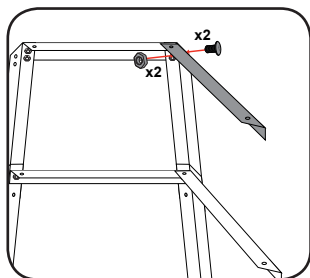

- 9 Repeat the same process for the other side, which should leave you with 2 identical halves.

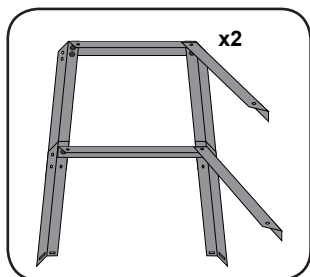

- 10 These halves can now be aligned together to complete the frame.

Note: Nuts & bolts should only be finger tight at this stage.

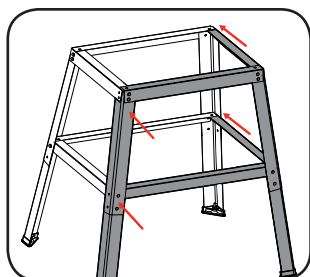

- 11 Align the holes of each opposing member. Bolts, washers and nuts can be inserted & tightened with hand force only.

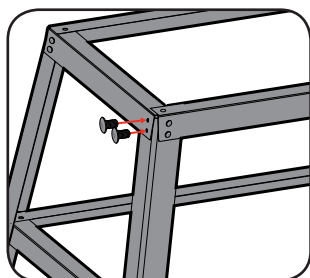

- 12 Insert a bolt into the 4 overlapping lower support holes and attach a washer and nut onto each.

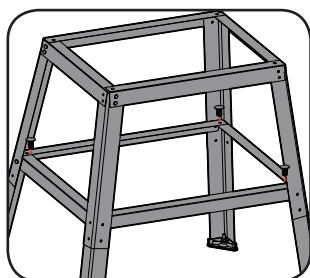

- 12 Once all of the members are joined together and all fasteners are assembled, place the 4 mounting bolts into the holes at the top of the stand. This will ensure the mounting holes align correctly while the stand is tightened. Tighten all nuts and bolts firmly.

Note: We recommend that the stand is mounted to a stable surface for additional stability.

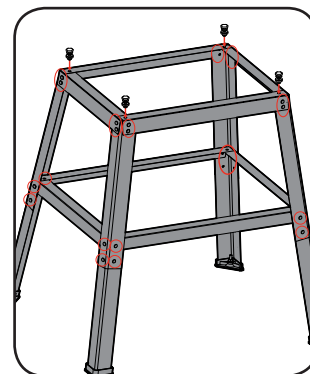

- 13 The Rubber Feet can now be fitted and the large bolts with rubber stops inserted into the rubber feet. These bolts can be adjusted to level the stand.

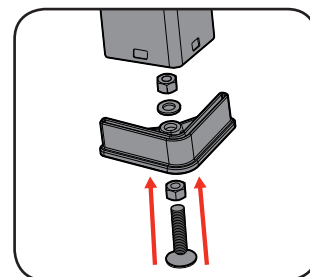

- 14 Remove the mounting bolts that you inserted prior to tightening the stand, then place the saw on the stand. The supplied mounting bolts, washers and nuts should be used to secure the saw to the top of the stand.

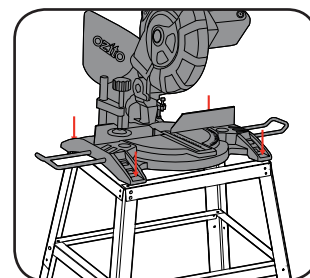

WARNING! ONLY USE THIS STAND WITH THE PROVIDED MITRE SAW. THE STAND MUST NOT BE USED WITH OTHER PRODUCTS OR FOR OTHER APPLICATIONS.

