

# ozito

## CORDLESS GRASS TRIMMER KIT

**18V Lithium Ion**

### INSTRUCTION MANUAL

#### SPECIFICATIONS

Voltage:	18V
Max. Width of Cut:	240mm
Battery:	1.5Ah Li-ion
Charge Time:	4-5 Hours
No Load Speed:	8,500/min
Weight:	1.9kg

[ozito.com.au](http://ozito.com.au)

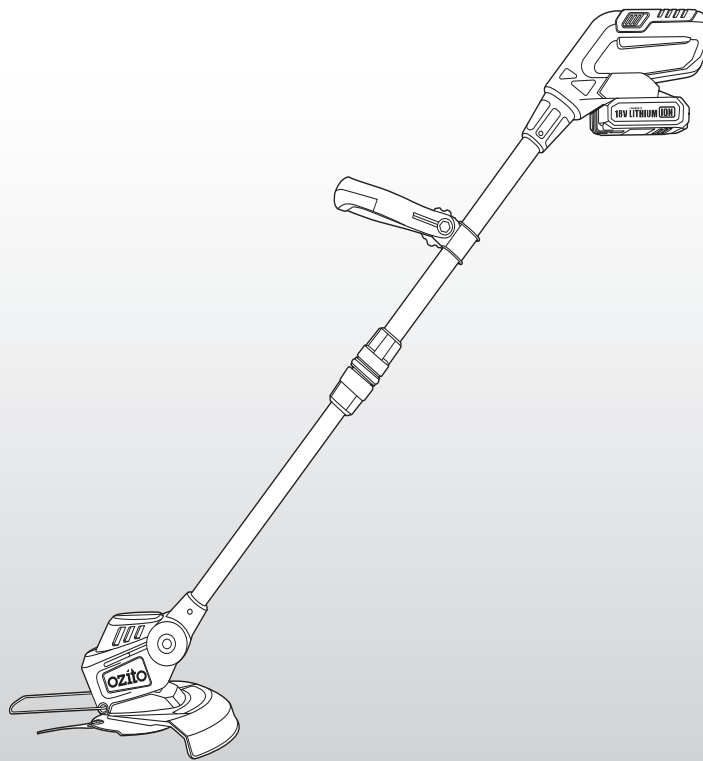

#### STANDARD EQUIPMENT

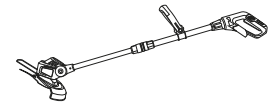

Grass Trimmer



Safety Guard



Replacement Blade

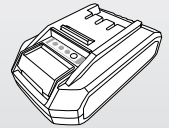

1.5Ah Battery Pack

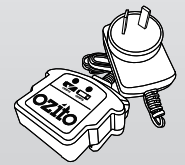

Battery Charger

**3** YEAR REPLACEMENT WARRANTY

**OGT-0185**

## WARRANTY

IN ORDER TO MAKE A CLAIM UNDER THIS WARRANTY YOU MUST RETURN THE PRODUCT TO YOUR NEAREST BUNNINGS WAREHOUSE WITH YOUR BUNNINGS REGISTER RECEIPT. PRIOR TO RETURNING YOUR PRODUCT FOR WARRANTY PLEASE TELEPHONE OUR CUSTOMER SERVICE HELPLINE:

**Australia 1800 069 486**

**New Zealand 0508 069 486**

TO ENSURE A SPEEDY RESPONSE PLEASE HAVE THE MODEL NUMBER AND DATE OF PURCHASE AVAILABLE. A CUSTOMER SERVICE REPRESENTATIVE WILL TAKE YOUR CALL AND ANSWER ANY QUESTIONS YOU MAY HAVE RELATING TO THE WARRANTY POLICY OR PROCEDURE.

The benefits provided under this warranty are in addition to other rights and remedies which are available to you at law.

Our goods come with guarantees that cannot be excluded at law. You are entitled to a replacement or refund for a major failure and for compensation for any other reasonably foreseeable loss or damage. You are also entitled to have the goods repaired or replaced if the goods fail to be of acceptable quality and the failure does not amount to a major failure.

Generally you will be responsible for all costs associated with a claim under this warranty, however, where you have suffered any additional direct loss as a result of a defective product you may be able to claim such expenses by contacting our customer service helpline above.

### 3 YEAR REPLACEMENT WARRANTY

Your product is guaranteed for a period of **36 months from the original date of purchase** and is intended for DIY (Do It Yourself) use only. If a product is defective it will be replaced in accordance with the terms of this warranty. **Lithium Ion batteries are covered by a 12 month warranty.** Warranty excludes consumable parts, for example: blades.

### WARNING

**The following actions will result in the warranty being void.**

- If the tool has been operated on a supply voltage other than that specified on the tool.
- If the tool shows signs of damage or defects caused by or resulting from abuse, accidents or alterations.
- Failure to perform maintenance as set out within the instruction manual.
- If the tool is disassembled or tampered with in any way.
- Professional, industrial or high frequency use

# KNOW YOUR PRODUCT

## CORDLESS GRASS TRIMMER

- |                            |                     |
|----------------------------|---------------------|
| 1. Tree/flower guard       | 7. Lock-off switch  |
| 2. Motor housing           | 8. Sure grip handle |
| 3. Telescopic shaft        | 9. Blade            |
| 4. Shaft adjustment collar | 10. Spindle plate   |
| 5. Adjustable handle       | 11. Safety guard    |
| 6. On/off trigger          | 12. Battery seating |

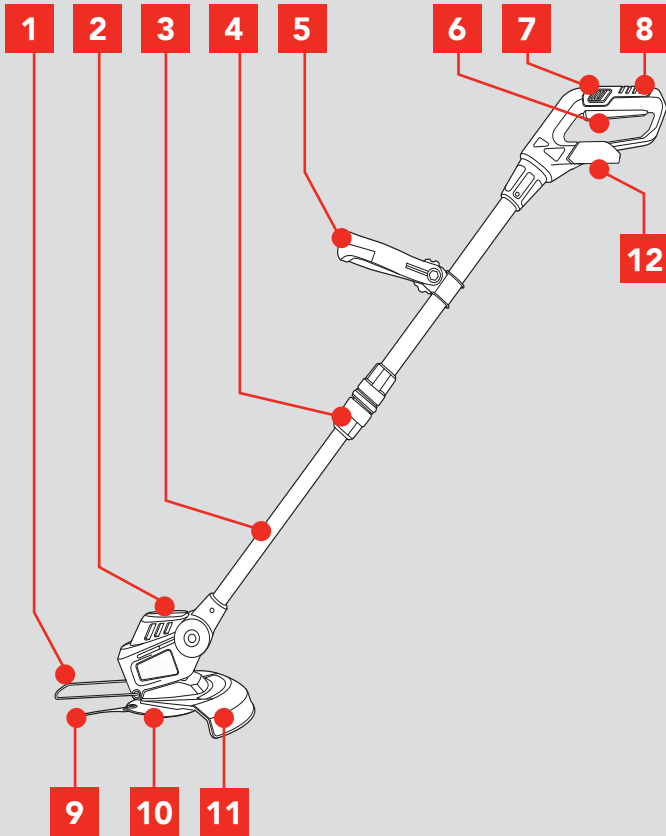

## ACCESSORIES

- |                               |                            |
|-------------------------------|----------------------------|
| 13. Battery release button    | 17. Charger LED indicators |
| 14. Battery charge indicators | 18. Charger adaptor        |
| 15. Charger indicator button  | 19. Replacement blade      |
| 16. Charging cradle           |                            |

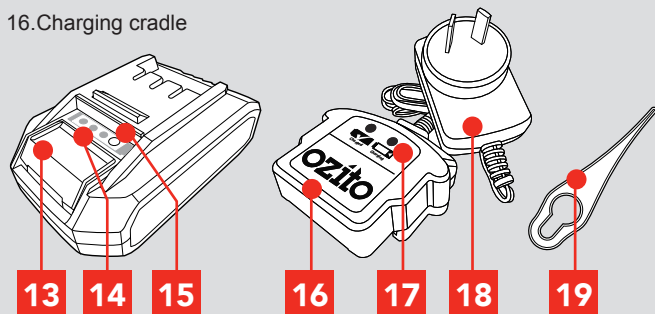

## ONLINE MANUAL

Scan this QR Code with your mobile device to take you to the online manual.



# SETUP & PREPARATION

## 1. ASSEMBLY

**CAUTION!** ENSURE THE TOOL IS OFF & THE BATTERY REMOVED BEFORE PERFORMING ANY OF THE FOLLOWING OPERATIONS.

### Fitting the Safety Guard

Turn the grass trimmer upside down. Align the recess in the safety guard with the tabs of the cutter head. Slide in until it clicks into place.

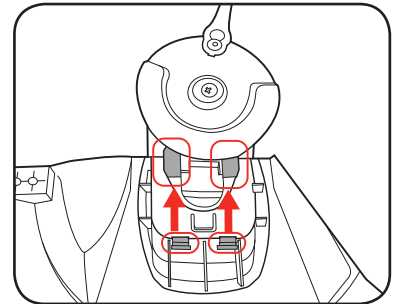

**WARNING!** NEVER USE THE GRASS TRIMMER UNLESS THE SAFETY GUARD IS PROPERLY FITTED.

### Attaching and Replacing Blade

1. Place the big hole in the blade onto the blade mount on the bottom of the spindle plate.

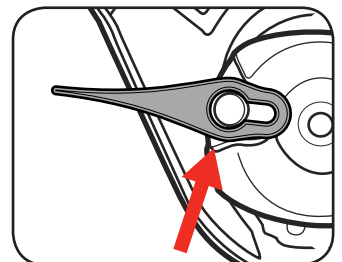

2. Pull the blade outwards so that the small hole is fitted into the mount.

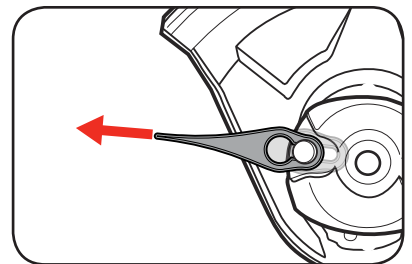

3. To remove the blade push the blade towards the centre of the spindle and then slide off.

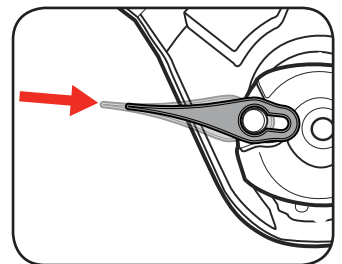

**WARNING!** STONES, PIECES OF METAL AND OTHER OBJECTS CAN BE THROWN OUT AT HIGH SPEED BY THE BLADES.

**3** YEAR REPLACEMENT WARRANTY

## 2. BATTERY CHARGING

### Charging the Li-Ion Battery

**CAUTION:** TO REDUCE THE RISK OF ELECTRICAL SHOCK, WE RECOMMEND THE USE OF A RESIDUAL CURRENT DEVICE (RATED 30mA OR LESS).

Allow at least 3 hours of charge time before initial use of the battery. Charge the battery pack only with the charger provided. The battery should be charged in a cool dry place. It will take 2 to 3 charging/discharging cycles before the battery achieves maximum run time capacity.

**Note:** The battery will not develop a memory, it does not have to be fully discharged before recharging.

1. Connect the charging adaptor into the mains power outlet.
2. The charger LED will flash green showing power is being supplied to the charger.
3. With the battery sitting on a flat surface, align the raised ribs on the battery with the recess in the charger cradle and slide onto the battery ensuring a firm connection.

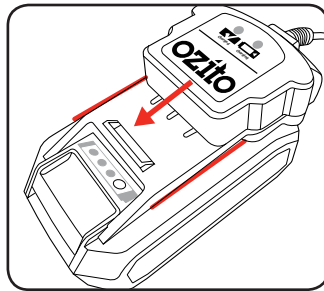
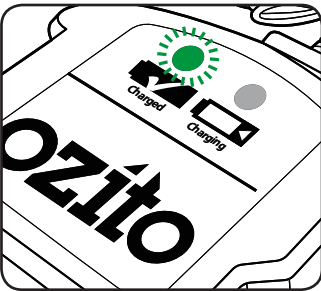

4. The charger LED will illuminate red signifying that the battery is charging. Battery is fully charged after 4-5 hours, green LED will turn on.
5. When removing the charger from the battery, first press the battery release tab, then slide the cradle from its position.

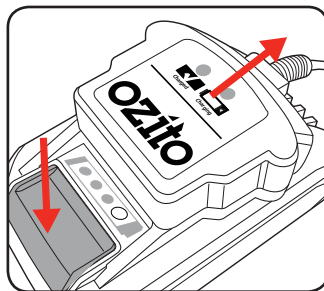

Charger LED Indicator	
LED Indicator	Situation
GREEN (Flashing)	Stand By (no battery pack is inserted)
RED (Illuminated)	Battery is charging (low charge)
GREEN (Illuminated)	Battery is fully charged.
GREEN & RED (Flashing)	Battery is faulty.
GREEN & RED (Illuminated)	Battery is too hot. Remove battery from charger a let cool. Insert battery again when at room temperature.

### Battery Charge Indicator

The included battery is equipped with a battery charge indicator to show the state of the battery charge.

Press the charge indicator button and check to see which LED light is on.

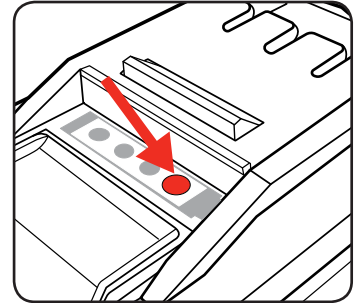

**1 GREEN LED** indicates that the battery has only a low charge and requires charging.



**2 GREEN LEDs** indicate that the battery has mid state of charge.



**3 GREEN LEDs** indicate that the battery is fully charged.



**Note:** The battery needs to be removed from the tool to check the state of charge.

### Battery Protection System

The tool is equipped with the battery protection system, which helps to ensure a long service life.

The output power automatically cuts off during operation when the tool and battery are placed under the following situations:

- **When tool is overloaded:**

If this occurs, turn off the tool and let it cool down for 10 mins, remove the cause of overload, then resume operation.

- **When the remaining battery capacity becomes low:**

Recharge the battery pack.

**Note:** The battery protection system does not in any way damage the tool.

**Note:** The indicated capacity may be lower than the actual level during use or immediately after using the tool.

# OPERATION

## 3. ADJUSTMENTS

### Adjustable Handle

1. Loosen the locking knob.

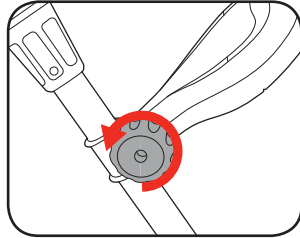

2. Rotate the handle into the desired position and then tighten the locking knob.

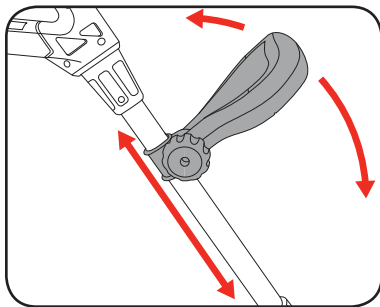

### Adjusting the Height

The Telescopic Shaft can be adjusted to suit different user heights.

1. Loosen the shaft adjustment collar.

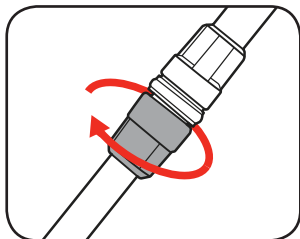

2. Extend to the desired height and retighten the adjustment collar to secure in place.

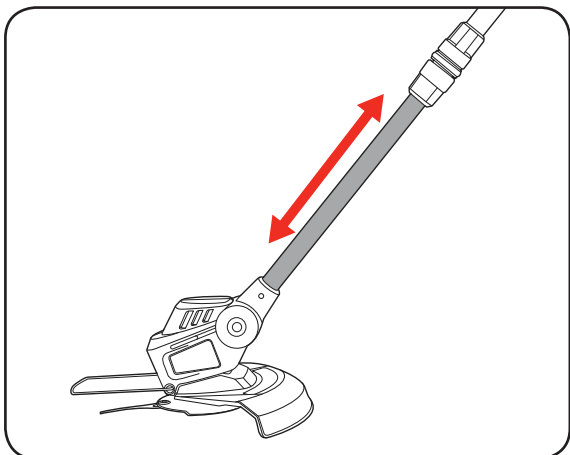

## 4. INSERTING & REMOVING THE BATTERY

### Inserting the Battery into the Grass Trimmer

1. Align the ribs of the battery and the recess behind the handle.
2. Slide the battery in so that it clicks into place.

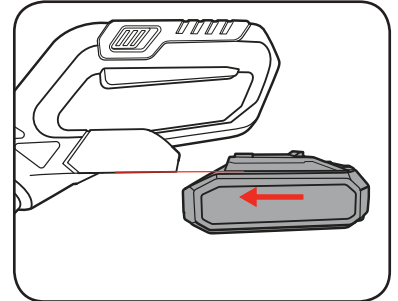

### Removing the Battery from the Grass Trimmer

1. Press and hold the battery release button (a) to release the battery.
2. Slide the battery (b) out.

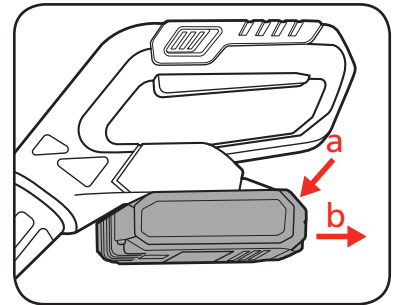

## 5. CONTROLS

### Switching On and Off

For your safety this Grass Trimmer is designed with a safety lock off mechanism. This prevents accidental starting. If you only squeeze the on/off trigger the Grass Trimmer will not start.

**CAUTION!** BEFORE YOU START THE UNIT, MAKE SURE THAT THE GRASS TRIMMER IS NOT MAKING CONTACT WITH ANY OBJECTS.

1. Slide and hold the lock-off switch with your thumb.

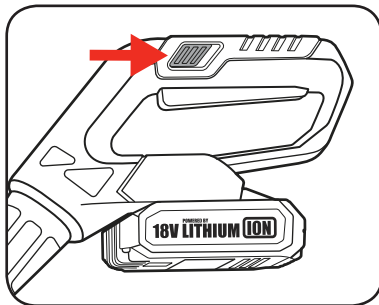

2. Squeeze the on/off trigger to start the grass trimmer.

**Note:** Once started the lock-off switch can be release

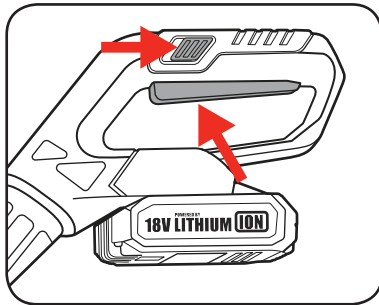

3. To stop the grass trimmer, release the on/off trigger.

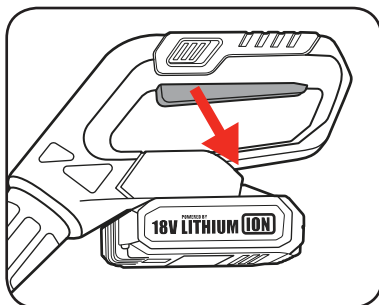

**WARNING!** THE CUTTING ELEMENTS CONTINUE TO ROTATE FOR A FEW SECONDS AFTER THE MOTOR IS SWITCHED OFF.

## 6. USING THE GRASS TRIMMER

### Trimming

- Before inserting the battery, extend the tree/flower guide to prevent the cutting head from getting too close to an object such as a tree trunk or wall.

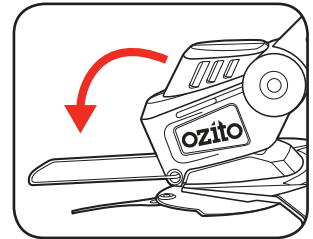

**WARNING!** INSPECT THE AREA TO BE TRIMMED AND REMOVE ANY WIRE, CORD OR STRING-LIKE OBJECTS WHICH COULD BECOME ENTANGLED IN THE ROTATING SPINDLE PLATE.

- Start the grass trimmer before approaching the grass to be cut.

**Note:** The best results will be achieved by cutting dry grass.

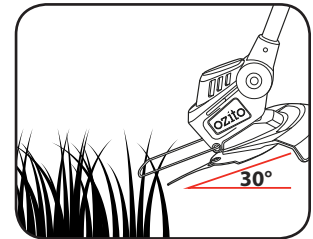

- Stand with the cutting head tipped down at an 30° angle in front, guiding the grass trimmer in a semi-circular motion around you.

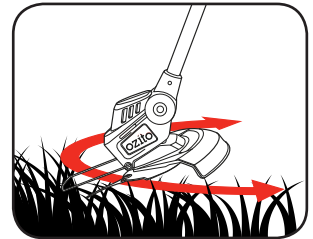

- When cutting long grass, cut in stages from the top of the grass to the bottom of the grass.

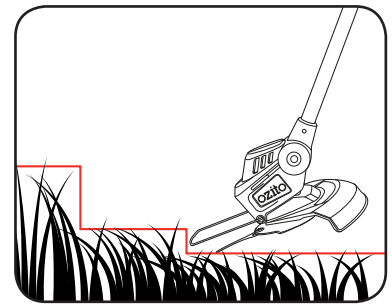

- Use only the tip of the cutting blade to do the trimming especially near walls and fences. Trimming with the side of the cutting blade may overload the motor, wear out the blades faster, and break the blades more often.

**Note:** If the motor starts to slow down, reduce the cutting load.

- If the grass trimmer is not cutting correctly, the blade will need to be replaced, refer to the assembly section of this manual.
- After finishing the cutting operation, keep the head close to ground level, release the trigger switch and allow the motor to come to a complete standstill. Place the grass trimmer on the ground, and remove the battery.

**CAUTION!** BYSTANDERS MUST KEEP A MINIMUM SAFE DISTANCE OF 10M AWAY FROM THE GRASS TRIMMER WHILE IT IS OPERATING.

# MAINTENANCE

**WARNING!** ALWAYS ENSURE THE TOOL HAS COMPLETELY STOPPED AND THE BATTERY IS REMOVED PRIOR TO ANY MAINTENANCE.

## Replacing the Spindle Plate

1. Unscrew the countersunk head screw in the centre of the spindle plate, rotate anti-clockwise to remove. Once removed put aside for re-assembly.

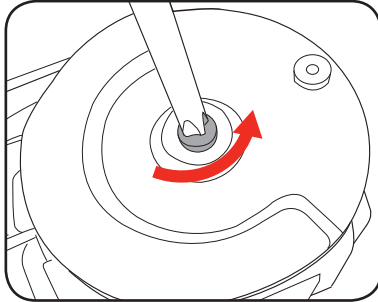

2. Lift off the spindle plate.

3. Mount and fasten the new spindle plate.

- Keep ventilation slots of the trimmer clean at all times. Periodically clean out the grass from the spindle plate and the rim of the safety guard to ensure efficient operation at all times.
- After each use, blow air through the tool housing to ensure it is free from all dust, dirt, etc. Build up of dust, dirt particles may cause the tool to overheat and shorten the life of the tool.
- If the housing of the grass trimmer requires cleaning, do not use solvents but a moist soft cloth or soft brush only.
- Never let any liquid get inside the tool, never immerse any part of the tool into liquid.
- No lubrication is necessary as the tool has sealed bearings.
- When not in use, the grass trimmer should be stored in a dry, frost free location not within the reach of children.

*Note: Ozito Industries will not be responsible for any damage or injuries caused by the repair of the grass trimmer by an unauthorised person or by mishandling of the grass trimmer. This tool is designed for DIY use - use in commercial or industrial environments will void the warranty.*

# TROUBLESHOOTING

Problem	Cause	Remedy
Trimmer is not starting	Possible clogging	Clean the cutter head of any grass.
	Battery is low in charge	Charge battery
	Battery not inserted properly	Insert battery pack correctly
Trimmer is not operating at full capacity	Possible clogging	Clean the cutter head of any grass.
	Cutting tall grass at ground level.	Make several passes from top down.
Motor stops while operating	Battery has no power	Charge battery
Grass wraps around the shaft and spindle plate	Cutting tall grass at ground level.	Make several passes from top down.

# SPARE PARTS

Spare Part	Part No.
Blades (20 pack)	PXCLTA-020
Blades (50 pack)	PXCLTA-050

Spare parts can be ordered from the Special Orders Desk at your local Bunnings Warehouse. For further information, or any parts not listed here, visit [www.ozito.com.au](http://www.ozito.com.au) or contact Ozito Customer Service: Australia 1800 069 486 New Zealand 0508 069 486 E-mail: [enquiries@ozito.com.au](mailto:enquiries@ozito.com.au)

# CARING FOR THE ENVIRONMENT



Power tools that are no longer usable should not be disposed of with household waste but in an environmentally friendly way. Please recycle where facilities exist. Check with your local council authority for recycling advice.



Recycling packaging reduces the need for landfill and raw materials. Reuse of recycled material decreases pollution in the environment. Please recycle packaging where facilities exist. Check with your local council authority for recycling advice.

# DESCRIPTION OF SYMBOLS

<b>V</b>	Volts	<b>Hz</b>	Hertz
<b>~</b>	Alternating current	<b>W</b>	Watts
<b>dc/—</b>	Direct current	$\emptyset$	Diameter
<b>mA</b>	Milliamperes	<b>No</b>	No load speed
<b>/min</b>	Revolutions or reciprocation per minute		Double insulated
	Regulator compliance mark		Transformer Energy Rating (MEPS)
	Wear hearing protection		Wear safety glasses
	Thermal cut-out protection		Do not expose to rain.
	Indoor use only		Warning
	Lithium Ion- battery		Do not use or store battery in temperatures exceeding 50°C
	Recycle battery		Do not put in the rubbish
	Do not incinerate		Do not get battery wet
	Read instruction manual		Sound power level
	Keep bystanders away. Do not operate whilst people especially children or pets are in the area.		

# BATTERY AND CHARGER SAFETY WARNINGS

THIS MANUAL CONTAINS IMPORTANT SAFETY AND OPERATING INSTRUCTIONS FOR YOUR BATTERY CHARGER.

- Before using the charger read all instructions and cautionary markings on the charger, battery pack and the product using the battery pack.
- This charger is not intended for any uses other than charging rechargeable batteries. Any other use may result in risk of fire, electric shock or electrocution.
- Do not place any object on top of the charger or place the charger on a soft surface that may result in excessive internal heat. Place the charger in a position away from any heat source.
- To reduce risk of damage to the electric plug and cord, pull by the plug rather than the cord when disconnecting the charger.
- Make sure the cord is located so that it will not be stepped on, tripped over, or otherwise subjected to damage or stress.
- An extension cord should not be used unless absolutely necessary. Use of an improper extension cord could result in the risk of fire, electric shock or electrocution.
- Do not operate the charger if it has received a sharp blow, been dropped or otherwise damaged in any way. Have it checked by an electrician or power tool repairer.
- Do not disassemble charger. Take it to an electrician or power tool repairer when service or repair is required. Incorrect reassembly may result in a risk of electric shock, electrocution or fire.
- To reduce risk of electric shock, unplug the charger from the outlet before attempting any cleaning. Removing the battery pack will not reduce this risk. Never attempt to connect 2 chargers together.
- DO NOT store or use the tool and battery pack in locations where the temperature may reach or exceed 40°C (such as inside sheds or metal buildings in summer).
- The charger is designed to operate on standard household electrical power (240 volts). Do not attempt to use it on any other voltage!
- The battery pack is not fully charged out of the carton. First read the safety instructions and then follow the charging notes and procedures.
- The longest life and best performance can be obtained if the battery pack is charged when the air temperature is between 18 - 24°C. Do not charge the battery pack in an air temperature below 10°C or above 40°C. This is important and will prevent damage to the battery pack.
- Do not incinerate the battery pack even if it is seriously damaged or is completely worn out. The battery can explode in a fire.
- Never attempt to open the battery pack for any reason. If the plastic housing of the battery pack breaks or cracks, immediately discontinue use and do not recharge.
- During charging, the battery must be placed in a well ventilated area.

# ELECTRICAL SAFETY

 **WARNING!** When using mains-powered tools, basic safety precautions, including the following, should always be followed to reduce risk of fire, electric shock, personal injury and material damage.

Read the whole manual carefully and make sure you know how to switch the tool off in an emergency, before operating the tool.

Save these instructions and other documents supplied with this tool for future reference.

The charger has been designed for 230V and 240V only. Always check that the power supply corresponds to the voltage on the rating plate.

**Note:** The supply of 230V and 240V on Ozito tools are interchangeable for Australia and New Zealand.



This tool's charger is double insulated therefore no earth wire is required.

The power supply for this product's charger should be protected by a residual current device (rated at 30mA or less). A residual current device reduces the risk of electric shock.

If the supply cord is damaged, it must be replaced by the manufacturer, its service agent or similarly qualified persons in order to avoid a hazard.

**Note:** Double insulation does not take the place of normal safety precautions when operating this tool. The insulation system is for added protection against injury resulting from a possible electrical insulation failure within the tool.

# GENERAL POWER TOOL SAFETY WARNINGS

 **WARNING!** Read all safety warnings and all instructions. Failure to follow the warnings and instructions may result in electric shock, fire and/or serious injury.

Save all warnings and instructions for future reference. The term "power tool" in the warnings refers to your mains-operated (corded) power tool or battery-operated (cordless) power tool.

## 1. Work area safety

- Keep work area clean and well lit. Cluttered or dark areas invite accidents.
- Do not operate power tools in explosive atmospheres, such as in the presence of flammable liquids, gases or dust. Power tools create sparks which may ignite the dust or fumes.
- Keep children and bystanders away while operating a power tool. Distractions can cause you to lose control.

## 2. Electrical safety

- Power tool plugs must match the outlet. Never modify the plug in any way. Do not use any adapter plugs with earthed (grounded) power tools. Unmodified plugs and matching outlets will reduce risk of electric shock.
- Avoid body contact with earthed or grounded surfaces, such as pipes, radiators, ranges and refrigerators. There is an increased risk of electric shock if your body is earthed or grounded.
- Do not expose power tools to rain or wet conditions. Water entering a power tool will increase the risk of electric shock.
- Do not abuse the cord. Never use the cord for carrying, pulling or unplugging the power tool. Keep cord away from heat, oil, sharp edges or moving parts. Damaged or entangled cords increase the risk of electric shock.
- When operating a power tool outdoors, use an extension cord suitable for outdoor use. Use of a cord suitable for outdoor use reduces the risk of electric shock.
- If operating a power tool in a damp location is unavoidable, use a residual current device (RCD) protected supply. Use of an RCD reduces the risk of electric shock.

## 3. Personal safety

- Stay alert, watch what you are doing and use common sense when operating a power tool. Do not use a power tool while you are tired or under the influence of drugs, alcohol or medication. A moment of inattention while operating power tools may result in serious personal injury.
- Use personal protective equipment. Always wear eye protection. Protective equipment such as dust mask, non-skid safety shoes, hard hat, or hearing protection used for appropriate conditions will reduce personal injuries.
- Prevent unintentional starting. Ensure the switch is in the off-position before connecting to power source and/or battery pack, picking up or carrying the tool. Carrying power tools with your finger on the switch or energising power tools that have the switch on invites accidents.
- Remove any adjusting key or wrench before turning the power tool on. A wrench or a key left attached to a rotating part of the power tool may result in personal injury.
- Do not overreach. Keep proper footing and balance at all times. This enables better control of the

power tool in unexpected situations.

- Dress properly. Do not wear loose clothing or jewellery. Keep your hair, clothing and gloves away from moving parts. Loose clothes, jewellery or long hair can be caught in moving parts.
  - If devices are provided for the connection of dust extraction and collection facilities, ensure these are connected and properly used. Use of dust collection can reduce dust-related hazards.
- ## 4. Power tool use and care
- Do not force the power tool. Use the correct power tool for your application. The correct power tool will do the job better and safer at the rate for which it was designed.
  - Do not use the power tool if the switch does not turn it on and off. Any power tool that cannot be controlled with the switch is dangerous and must be repaired.
  - Disconnect the plug from the power source and/or the battery pack from the power tool before making any adjustments, changing accessories, or storing power tools. Such preventive safety measures reduce the risk of starting the power tool accidentally.
  - Store idle power tools out of the reach of children and do not allow persons unfamiliar with the power tool or these instructions to operate the power tool. Power tools are dangerous in the hands of untrained users.
  - Maintain power tools. Check for misalignment or binding of moving parts, breakage of parts and any other condition that may affect the power tool's operation. If damaged, have the power tool repaired before use. Many accidents are caused by poorly maintained power tools.
  - Keep cutting tools sharp and clean. Properly maintained cutting tools with sharp cutting edges are less likely to bind and are easier to control.
  - Use the power tool, accessories and tool bits etc. in accordance with these instructions, taking into account the working conditions and the work to be performed. Use of the power tool for operations different from those intended could result in a hazardous situation.
- ## 5. Battery tool use and care
- Recharge only with the charger specified by the manufacturer. A charger that is suitable for one type of battery pack may create a risk of fire when used with another battery pack.
  - Use power tools only with specifically designated battery packs. Use of any other battery packs may create a risk of injury and fire.
  - When battery pack is not in use, keep it away from other metal objects, like paper clips, coins, keys, nails, screws or other small metal objects, that can make a connection from one terminal to another. Shorting the battery terminals together may cause burns or a fire.
  - Under abusive conditions, liquid may be ejected from the battery; avoid contact. If contact accidentally occurs, flush with water. If liquid contacts eyes, additionally seek medical help. Liquid ejected from the battery may cause irritation or burns.
- ## 6. Service
- Have your power tool serviced by a qualified repair person using only identical replacement parts. This will ensure that the safety of the power tool is maintained.

# GRASS TRIMMER SAFETY WARNINGS

Hold power tool by insulated gripping surfaces, when performing an operation where the cutting accessory may contact hidden wiring. Cutting accessory contacting a "live" wire may make exposed metal parts of the power tool "live" and could give the operator an electric shock.

This appliance is not intended for use by persons (including children) with reduced physical, sensory or mental capabilities, or lack of experience and knowledge, unless they have been given supervision or instruction concerning use of the appliance by a person responsible for their safety.

- Never allow children or people unfamiliar with these instructions to use the line trimmer.
- Avoid using the line trimmer, while people, especially children or pets, are nearby.
- Use the line trimmer only in daylight or good artificial light.
- Never operate the line trimmer with damaged guards or without guards in place.
- Switch on the line trimmer only when the hands and feet are away from the cutting head.
- Never fit metal cutting blades.
- Use only the manufacturer's recommended replacement parts and accessories.
- Always remove the battery from the line trimmer when leaving the line trimmer unattended.
- Always remove the battery from the line trimmer before carrying out maintenance or cleaning work.
- Inspect and maintain the line trimmer regularly. Have the line trimmer repaired only by an authorized repairer.

- Take care against injury from the blade(s) fitted for trimming the cutting line length. After extending new cutting line, always return the line trimmer to its normal operating position before switching on.
- When not in use, store the line trimmer out of the reach of children.
- Face the cutting head away from yourself, other people and animals while the power is connected to the line trimmer (especially during operation).
- Remove the battery when changing spools or clearing grass from under the guard.
- Remove the battery from the line trimmer before making any adjustments.
- Use both handles.
- Keep ventilation openings clear of debris. Keep handles dry, clean and free of oil and grease.
- Never reach underneath the line trimmer (the cutting line area) until it has completely stopped and the battery has been removed.

 **WARNING!** When servicing, use only identical replacement parts. Use of any other parts may create a hazard or cause product damage. To ensure safety and reliability, all repairs should be performed by a qualified service technician.

 **WARNING!** This appliance is not intended for use by young or infirm persons unless supervised by a responsible person to ensure that they can use the appliance safely. Children should be supervised to ensure that they do not play with the appliance.