

# ozito

## CROSS LINE LASER LEVEL

**8m Working Range**

### INSTRUCTION MANUAL

#### SPECIFICATIONS

Battery:	3V DC (2 x AA Battery)
Laser Power:	Class 2, <1mW
Working Range:	8m
Laser Diode:	635nm
Accuracy:	±0.5mm/m
Self-Levelling Range:	±4°
Weight:	0.2kg

[ozito.com.au](http://ozito.com.au)

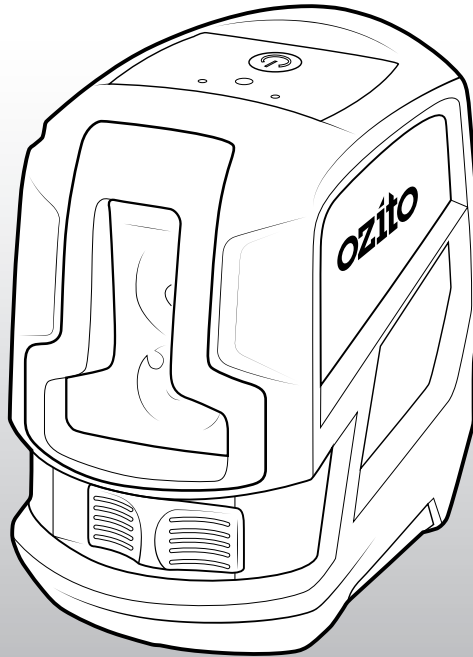

#### WHAT'S IN THE BOX



Cross Line Laser Level

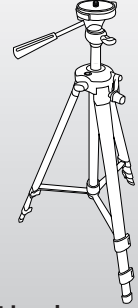

Tripod

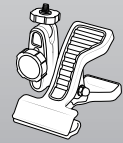

Mounting Clamp

# 3 YEAR REPLACEMENT WARRANTY

**LCT-1805**

## WARRANTY

IN ORDER TO MAKE A CLAIM UNDER THIS WARRANTY YOU MUST RETURN THE PRODUCT TO YOUR NEAREST BUNNINGS WAREHOUSE WITH YOUR BUNNINGS REGISTER RECEIPT. PRIOR TO RETURNING YOUR PRODUCT FOR WARRANTY PLEASE TELEPHONE OUR CUSTOMER SERVICE HELPLINE:

**Australia 1800 069 486**

**New Zealand 0508 069 486**

TO ENSURE A SPEEDY RESPONSE PLEASE HAVE THE MODEL NUMBER AND DATE OF PURCHASE AVAILABLE. A CUSTOMER SERVICE REPRESENTATIVE WILL TAKE YOUR CALL AND ANSWER ANY QUESTIONS YOU MAY HAVE RELATING TO THE WARRANTY POLICY OR PROCEDURE.

The benefits provided under this warranty are in addition to other rights and remedies which are available to you at law. Our goods come with guarantees that cannot be excluded at law. You are entitled to a replacement or refund for a major failure and for compensation for any other reasonably foreseeable loss or damage. You are also entitled to have the goods repaired or replaced if the goods fail to be of acceptable quality and the failure does not amount to a major failure.

Generally you will be responsible for all costs associated with a claim under this warranty, however, where you have suffered any additional direct loss as a result of a defective product you may be able to claim such expenses by contacting our customer service helpline above.

### 3 YEAR REPLACEMENT WARRANTY

Your product is guaranteed for a period of **36 months from the original date of purchase** and is intended for DIY (Do It Yourself) use only. If a product is defective it will be replaced in accordance with the terms of this warranty. **Lithium Ion batteries are covered by a 12 month warranty.** Warranty excludes consumable parts.

### WARNING

**The following actions will result in the warranty being void.**

- If the tool has been operated on a supply voltage other than that specified on the tool.
- If the tool shows signs of damage or defects caused by or resulting from abuse, accidents or alterations.
- Failure to perform maintenance as set out within the instruction manual.
- If the tool is disassembled or tampered with in any way.

# KNOW YOUR PRODUCT

## CROSS LINE LASER LEVEL WITH TRIPOD

- |                                  |                              |
|----------------------------------|------------------------------|
| 1 On/Off & Operating Mode Button | 3 Laser Window               |
| 2 Auto Levelling Indicator Light | 4 Automatic Levelling Switch |
|                                  | 5 Battery Compartment        |

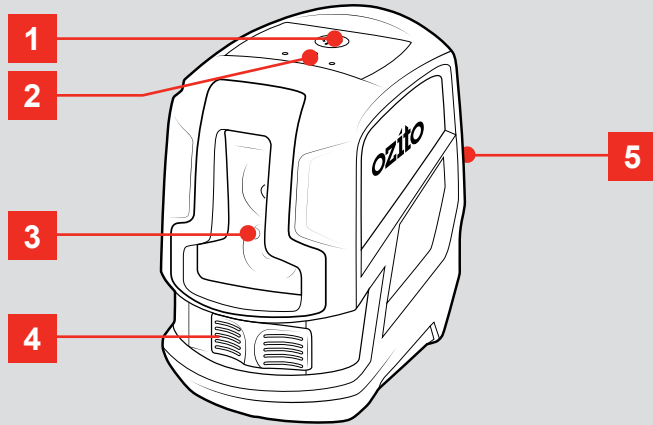

- |                              |                             |
|------------------------------|-----------------------------|
| 6 1/4" Tripod Mounting Plate | 11 Leg Locking Levers       |
| 7 Spirit Level               | 12 Tilt Locking Knob        |
| 8 Angle Adjusting Handle     | 13 Rotation Locking Knob    |
| 9 Height Locking Knob        | 14 Height Adjustment Handle |
| 10 Tripod Legs               |                             |

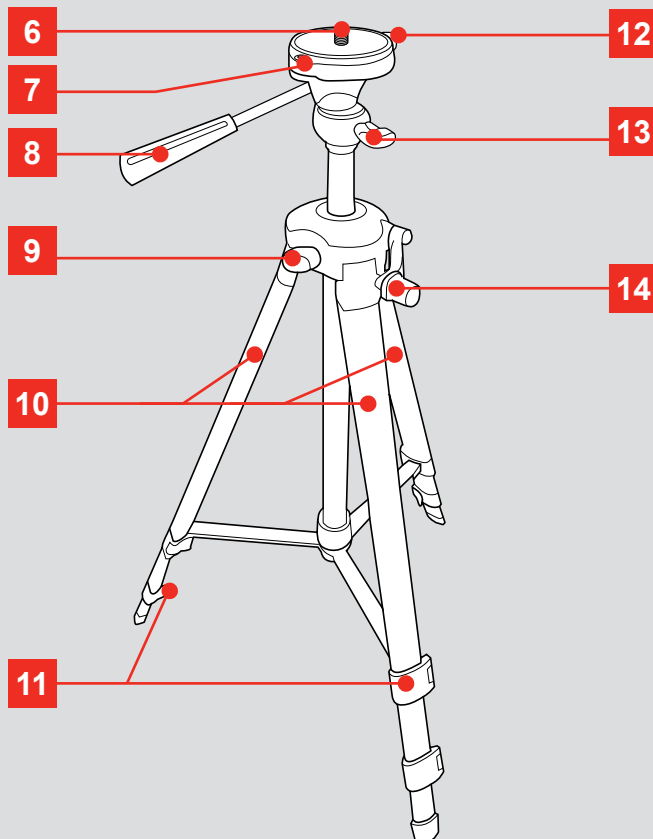

### ONLINE MANUAL

Scan this QR Code with your mobile device to take you to the online manual.



# SETUP & PREPARATION

## 1. INSTALLING BATTERIES

The Cross Line Laser Level unit requires 2 x AA batteries to operate.



**WARNING!** BEFORE INSTALLING BATTERIES, ENSURE THE UNIT IS SWITCHED OFF, INCLUDING AUTOMATIC LEVELLING SWITCH, TO PREVENT THE LASER FROM OPERATING.

- 1 Remove the battery compartment lid from the laser unit using the tab at the top.

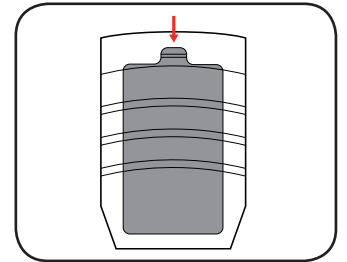

- 2 Insert 2 x AA batteries in the correct direction indicated by the embossing inside the battery compartment.

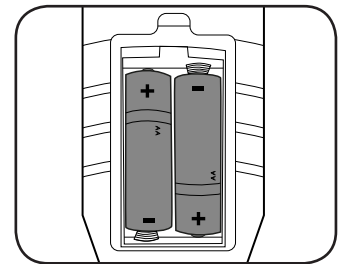

- 3 Place the bottom of the battery lid into the recess in the laser unit and push the lid tab down to secure in place.

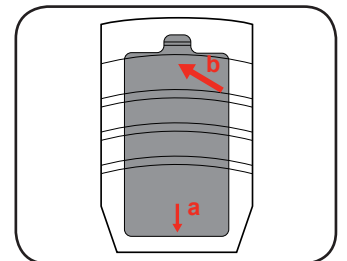

# 3 YEAR REPLACEMENT WARRANTY

## 2. USING THE TRIPOD

### Attaching the Laser to the Tripod

The tripod allows you to set up the laser in a specific position and easily make adjustments to the height, angle and tilt of the unit.

- 1 Open up the 3 legs of the tripod to stabilise the platform.

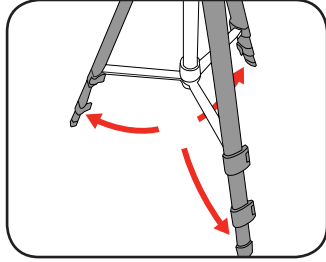

- 2 Align the 1/4" mount at the base of the laser unit with the 1/4" screw at the top of the tripod.

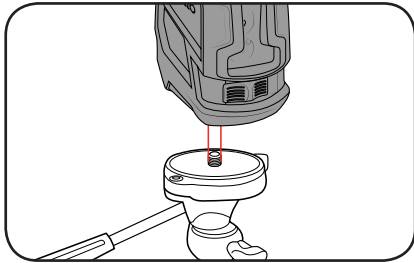

- 3 Rotate the laser unit clockwise to fasten the unit to the mounting plate securely.

**Note:** Make sure the laser is pointing perpendicular to the angle adjusting handle.

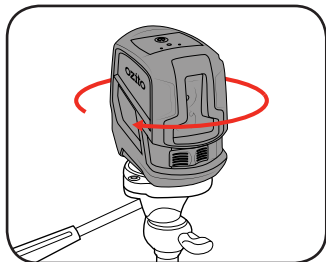

- 4 To remove the laser unit from the mounting plate, rotate the unit anti-clockwise.

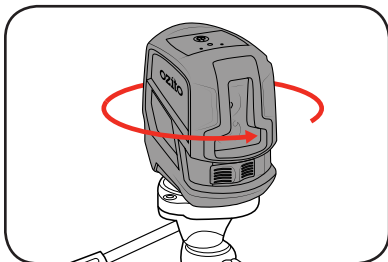

### Rotating the Laser

- 1 Loosen the rotation locking knob by rotating anti-clockwise. Adjust unit by using the angle adjusting handle.

**Note:** Secure in place after adjusting, by turning the rotation locking knob clockwise.

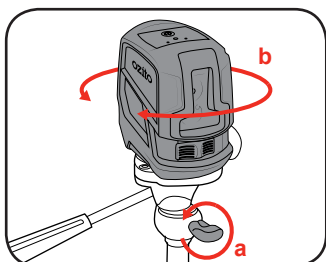

## 3. ADJUSTING THE TRIPOD

### Adjusting the Height of the Laser

- 1 Extend the 3 legs of the tripod by unlocking the leg locking levers and raising the legs.

**Note:** Ensure the locking levers are locked once desired height is achieved to secure the tripod.

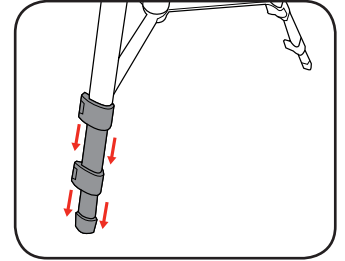

- 2 To raise the laser further, wind the height locking knob anti-clockwise to loosen, then raise the laser by winding the height adjustment handle.

**Note:** Ensure the height locking knob is secured after adjusting, by rotating clockwise.

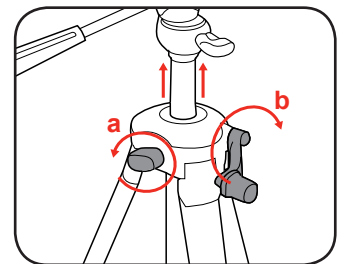

### Adjusting the Angle of the Laser

- 1 Rotate the angle adjusting handle anti-clockwise to allow the handle to move.

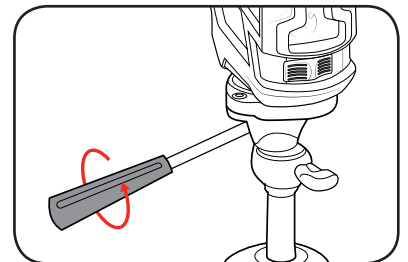

- 2 Adjust unit to the desired angle using the handle, then secure in place by rotating the handle clockwise.

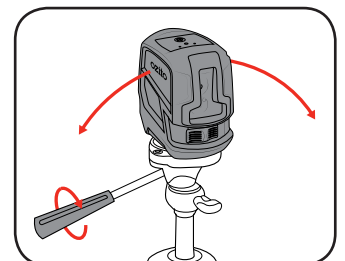

### Adjusting the Tilt of the Laser

- 1 Loosen the tilt locking knob by rotating anti-clockwise. Then adjust the tilt angle and secure in place again.

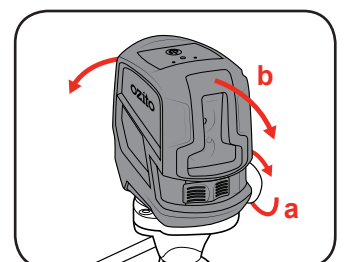

# OPERATION

## 4. USING THE MOUNTING CLAMP

### Attaching the Laser to the Mounting Clamp

The mounting clamp allows you to attach the laser to a table or shelf by clamping it in position.

- 1 Screw the laser clockwise onto the mounting clamp threaded rod.

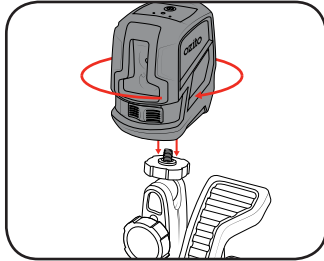

- 2 Squeeze the 2 tabs together to open the clamp. Place the clamp onto the table or shelf and release.

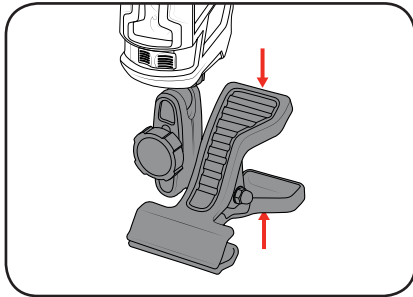

### Adjusting the Mounting Clamp

- 1 Unlock the adjustment by rotating the locking screw anti-clockwise

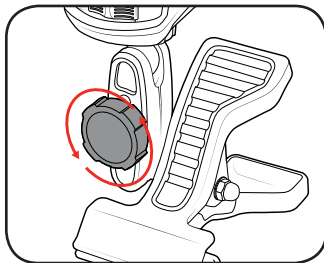

- 2 Adjust the laser into the desired orientation.

**Note:** Ensure you lock in the desired position by rotating the locking screw clockwise.

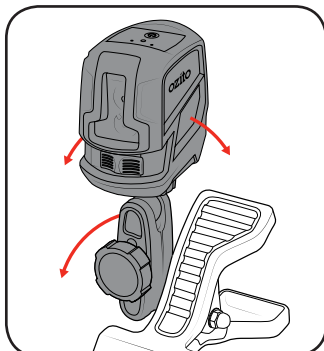

## 5. OPERATING THE LASER

### Switching the Laser On and Off

**WARNING!** ENSURE LASER WINDOW IS NOT AT EYE LEVEL WHEN OPERATING.

- 1 Turn laser on or off by pressing the on/off button at the top of the unit.

**Note:** Laser can also be turned on, in auto levelling mode by using the auto levelling switch.

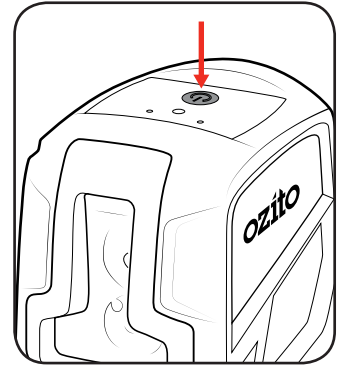

### Laser Operating Mode

The laser has 3 operating modes to assist in levelling as shown below.

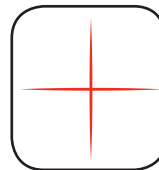

Cross Line

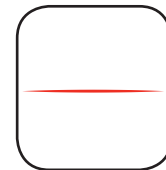

Horizontal Line

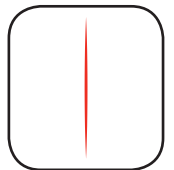

Vertical Line

- 1 To switch between these modes, simply press the on/off operating mode button until the desired mode is reached.

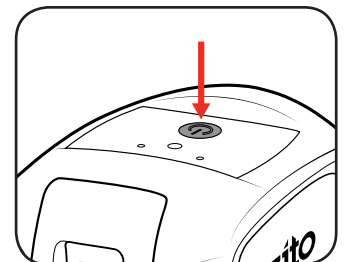

## Using the Auto-Levelling Function

A red flashing light shown at the top of the unit will indicate that the auto-levelling feature is turned off

A solid red light indicates that the unit is at an angle out of self auto-levelling range.

A green light indicates the auto-levelling switch is turned on and operating correctly.

- 1 Turn laser on or off by pressing the on/off button at the top of the unit.

**Note:** Laser can also be turned on, in auto-levelling mode by using the auto-levelling switch.

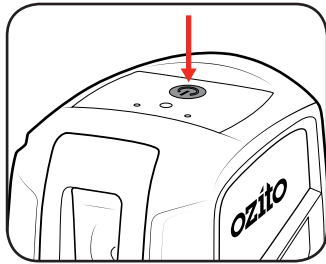

- 2 Press the auto-levelling switch left, into the unlocked position and then press the operating mode button to achieve the desired mode.

**Note:** Ensure the laser is level on tripod.

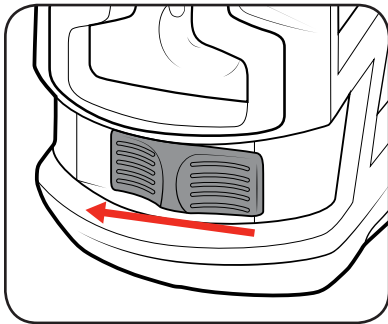

- 3 If the laser is at an angle greater than 4 degrees, the red light at the top of the laser will turn red and the laser line will flash. This indicates that the unit is at an angle out of self auto-levelling range.

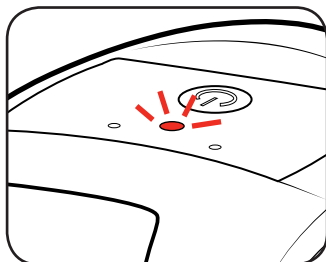

## Disabling Auto-Levelling feature to Create an Angled Line

- 1 Attach the laser to the tripod and adjust the tripod to the desired height, angle and tilt.

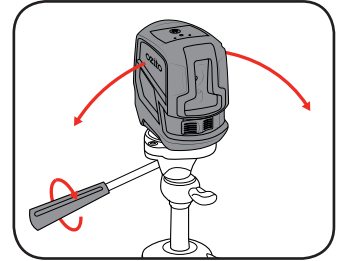





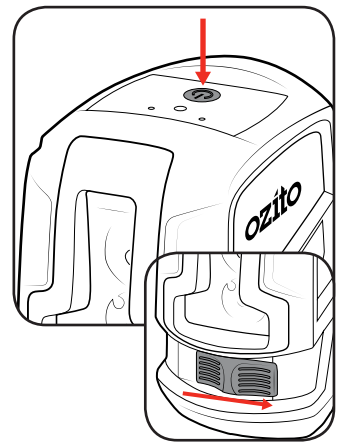

- 2 Turn the unit on using the on/off switch, ensuring that the auto-levelling switch is in off position. Press the on/off operating mode button until desired laser mode is achieved.

**Note:** The indicator light will glow red, indicating the auto-levelling feature is in-active.



# DESCRIPTION OF SYMBOLS

V	Volts	W	Watts
	Direct current		Read instruction manual
mW	Milliwatt		Regulatory Compliance Mark (RCM)
	Warning		Indoor use only
	Laser Light Laser Radiation		Do not put in the rubbish

# TROUBLESHOOTING

## Laser does not turn on

The batteries may be depleted. Ensure you have inserted 2 x AA batteries with a full charge.

Make sure the batteries are in the correct direction as indicated by the engraving on the bottom metal plate inside the battery compartment.

## The indicator light is glowing red

This indicates that the auto-levelling feature is not in use. This is desired if you require a line at an angle that is not level.

If this occurs when attempting to produce a level line, it means the angle of the unit is outside the auto-levelling range. You will need to reset the tripod to obtain a closer angle to level.

If this continues to occur even when placed on a level surface, it means that the batteries need replacing.

## Laser line is flashing

This indicates that the product is outside of auto-levelling range. This is desired if you require a line at an angle that is not level. To produce a level line, straighten the product on the tripod until green indicator light shows on top of the product.

# CARING FOR THE ENVIRONMENT



Power tools that are no longer usable should not be disposed of with household waste but in an environmentally friendly way. Please recycle where facilities exist. Check with your local council authority for recycling advice.



Recycling packaging reduces the need for landfill and raw materials. Reuse of recycled material decreases pollution in the environment. Please recycle packaging where facilities exist. Check with your local council authority for recycling advice.

# MAINTENANCE

**Note:** The LED light is not replaceable.

- When not in use, the tool should be stored in a dry, frost free location, keep out of children's reach.
- If the housing of the tool requires cleaning, do not use solvents but cloth only.

**Note:** Ozito Industries will not be responsible for any damage or injuries caused by repair of the tool by an unauthorised person or by mishandling of the tool.

# SPARE PARTS

Spare parts can be ordered from the Special Orders Desk at your local Bunnings Warehouse.

For further information, or any parts not listed here, visit [www.ozito.com.au](http://www.ozito.com.au) or contact Ozito Customer Service:

Australia 1800 069 486

New Zealand 0508 069 486

E-mail: [enquiries@ozito.com.au](mailto:enquiries@ozito.com.au)

# GENERAL POWER TOOL SAFETY WARNINGS



**WARNING!** Read all safety warnings and all instructions. Failure to follow the warnings and instructions may result in electric shock, fire and/or serious injury.

Save all warnings and instructions for future reference. The term “power tool” in the warnings refers to your mains-operated (corded) power tool or battery-operated (cordless) power tool.

## 1. Work area safety

- a. **Keep work area clean and well lit.** Cluttered or dark areas invite accidents.
- b. **Do not operate power tools in explosive atmospheres, such as in the presence of flammable liquids, gases or dust.** Power tools create sparks which may ignite the dust or fumes.
- c. **Keep children and bystanders away while operating a power tool.** Distractions can cause you to lose control.

## 2. Electrical safety

- a. **Power tool plugs must match the outlet. Never modify the plug in any way. Do not use any adapter plugs with earthed (grounded) power tools.** Unmodified plugs and matching outlets will reduce risk of electric shock.
- b. **Avoid body contact with earthed or grounded surfaces, such as pipes, radiators, ranges and refrigerators.** There is an increased risk of electric shock if your body is earthed or grounded.
- c. **Do not expose power tools to rain or wet conditions.** Water entering a power tool will increase the risk of electric shock.
- d. **Do not abuse the cord. Never use the cord for carrying, pulling or unplugging the power tool. Keep cord away from heat, oil, sharp edges or moving parts.** Damaged or entangled cords increase the risk of electric shock.
- e. **When operating a power tool outdoors, use an extension cord suitable for outdoor use.** Use of a cord suitable for outdoor use reduces the risk of electric shock.
- f. **If operating a power tool in a damp location is unavoidable, use a residual current device (RCD) protected supply.** Use of an RCD reduces the risk of electric shock.

## 3. Personal safety

- a. **Stay alert, watch what you are doing and use common sense when operating a power tool. Do not use a power tool while you are tired or under the influence of drugs, alcohol or medication.** A moment of inattention while operating power tools may result in serious personal injury.
- b. **Use personal protective equipment. Always wear eye protection.** Protective equipment such as dust mask, non-skid safety shoes, hard hat, or hearing protection used for appropriate conditions will reduce personal injuries.
- c. **Prevent unintentional starting. Ensure the switch is in the off-position before connecting to power source and/or battery pack, picking up or carrying the tool.** Carrying power tools with your finger on the switch or energising power tools that have the switch on invites accidents.
- d. **Remove any adjusting key or wrench before turning the power tool on.** A wrench or a key left attached to a rotating part of the power tool may result in personal injury.
- e. **Do not overreach. Keep proper footing and balance at all times.** This enables better control of the power tool in unexpected situations.

- f. **Dress properly. Do not wear loose clothing or jewellery. Keep your hair, clothing and gloves away from moving parts.** Loose clothes, jewellery or long hair can be caught in moving parts.
- g. **If devices are provided for the connection of dust extraction and collection facilities, ensure these are connected and properly used.** Use of dust collection can reduce dust-related hazards.

## 4. Power tool use and care

- a. **Do not force the power tool. Use the correct power tool for your application.** The correct power tool will do the job better and safer at the rate for which it was designed.
- b. **Do not use the power tool if the switch does not turn it on and off.** Any power tool that cannot be controlled with the switch is dangerous and must be repaired.
- c. **Disconnect the plug from the power source and/or the battery pack from the power tool before making any adjustments, changing accessories, or storing power tools.** Such preventive safety measures reduce the risk of starting the power tool accidentally.
- d. **Store idle power tools out of the reach of children and do not allow persons unfamiliar with the power tool or these instructions to operate the power tool.** Power tools are dangerous in the hands of untrained users.
- e. **Maintain power tools. Check for misalignment or binding of moving parts, breakage of parts and any other condition that may affect the power tool's operation. If damaged, have the power tool repaired before use.** Many accidents are caused by poorly maintained power tools.
- f. **Keep cutting tools sharp and clean.** Properly maintained cutting tools with sharp cutting edges are less likely to bind and are easier to control.
- g. **Use the power tool, accessories and tool bits etc. in accordance with these instructions, taking into account the working conditions and the work to be performed.** Use of the power tool for operations different from those intended could result in a hazardous situation.

## 5. Battery tool use and care

- a. **Recharge only with the charger specified by the manufacturer.** A charger that is suitable for one type of battery pack may create a risk of fire when used with another battery pack.
- b. **Use power tools only with specifically designated battery packs.** Use of any other battery packs may create a risk of injury and fire.
- c. **When battery pack is not in use, keep it away from other metal objects, like paper clips, coins, keys, nails, screws or other small metal objects, that can make a connection from one terminal to another.** Shorting the battery terminals together may cause burns or a fire.
- d. **Under abusive conditions, liquid may be ejected from the battery; avoid contact. If contact accidentally occurs, flush with water. If liquid contacts eyes, additionally seek medical help.** Liquid ejected from the battery may cause irritation or burns.

## 6. Service

- a. **Have your power tool serviced by a qualified repair person using only identical replacement parts.** This will ensure that the safety of the power tool is maintained.

# BATTERY & LASER LINE SAFETY WARNINGS

THIS MANUAL CONTAINS IMPORTANT SAFETY AND OPERATING INSTRUCTIONS FOR YOUR TOOL AND BATTERY

- DO NOT store or use the tool and battery pack in locations where the temperature may reach or exceed 40°C (such as inside sheds or metal buildings in summer).
- Do not incinerate the battery pack even if it is seriously damaged or is completely worn out. The battery can explode in a fire.

## Additional safety instructions for laser lights

The laser light/laser radiation used in the Ozito Cross Line Laser LCT-1805 laser is Class 2 with maximum 1mW and 650nm wavelengths. These lasers do not normally present an optical hazard, although staring at the beam may cause flash blindness.



**WARNING!** Do not stare directly at the laser beam. A hazard may exist if you deliberately stare into the beam. Please observe all safety rules as follows:

- The laser shall be used and maintained in accordance with the manufacturer's instructions.
- Never aim the beam at any person or an object other than the work piece.
- The laser beam shall not be deliberately aimed at personnel and shall be prevented from being directed towards the eye of a person for longer than 0.25s.
- Always ensure the laser beam is aimed at a sturdy work piece without reflective surface', i.e. wood or rough coated surfaces are acceptable. Bright shiny reflective sheet steel or the like is not suitable for laser use as the reflective surface could direct the beam back at the operator.
- Do not change the laser light assembly with a different type. Repairs must only be carried out by a power tool repairer.

**Caution:** Use of controls or adjustments or performance of procedures other than those specified herein may result in hazardous radiation exposure. Please refer to the relevant Australian standards, AS 2397 and AS/NZS2211 for more information on Lasers.