



# **FULL BOAR**

# **WET & DRY VACUUM**

- **40L STAINLESS STEEL TANK**
- **1150W MOTOR**
- **TRANSPORT TROLLEY**
- **3M SUCTION HOSE**



# **INSTRUCTION MANUAL**



**WARNING:** Read all safety warnings and instructions before use. Failure to follow the warnings and instructions may result in electric shock, fire and/or serious injury. Save these instructions for future reference.

## SPECIFICATIONS - MODEL NO. FBWDV-40PTU

<b>Mains voltage:</b>	220 - 240V ~ 50Hz
<b>Input power:</b>	1150W
<b>Power outlet max.:</b>	1450W
<b>Psum:</b>	2600W
<b>Suction power max.:</b>	230 mbar
<b>Tank capacity:</b>	40 l
<b>IP rating:</b>	IP24
<b>Weight:</b>	11 kg

## KNOW YOUR PRODUCT

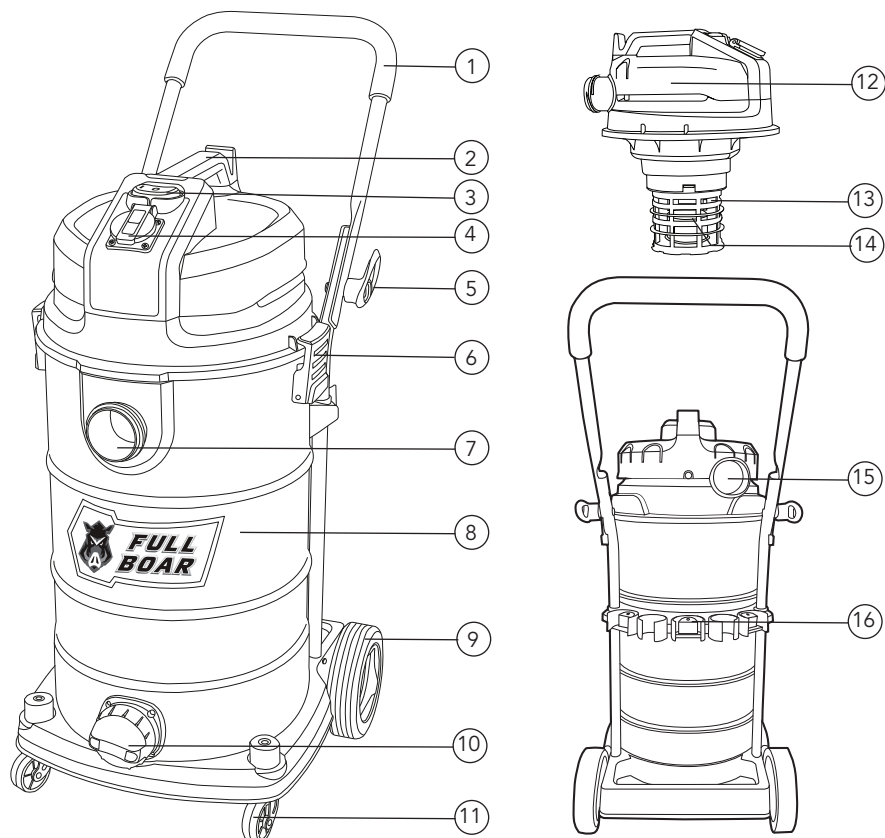

## KNOW YOUR PRODUCT (cont.)

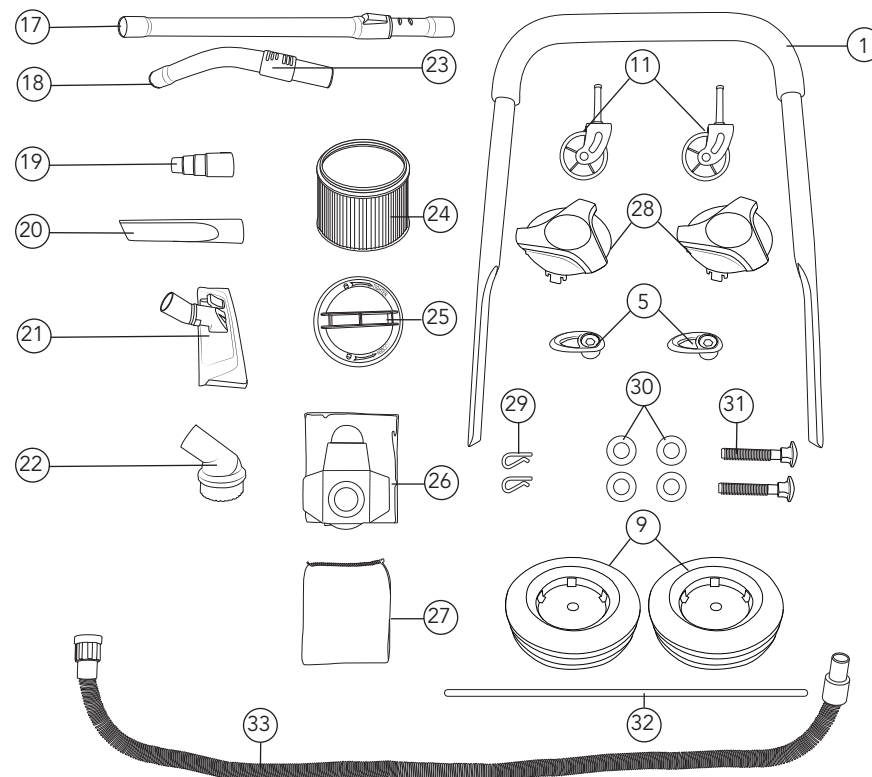

- |                            |  |   |
|----------------------------|--|---|
| 1. Main handle             | 15. Blow outlet                        | 30. 4 x washers for fitting the wheels    |
| 2. Carry handle            | 16. Accessory holder                   | 31. 2 x bolts for fitting the main handle |
| 3. ON/OFF/Automatic switch | 17. Suction tube                       | 32. Axle for fitting the wheels           |
| 4. Automatic power outlet  | 18. Tube handle                        | 33. Suction hose                          |
| 5. Cable hook              | 19. Hose adaptor                       |   |
| 6. Motor securing clip     | 20. Crevice tool                       |   |
| 7. Suction hose connection | 21. Floor tool                         |   |
| 8. Tank                    | 22. Upholstery tool                    |   |
| 9. Wheels                  | 23. Air regulator                      |   |
| 10. Water drain outlet     | 24. Pleated filter (dry)               |   |
| 11. Castors                | 25. Cap                                |   |
| 12. Motor                  | 26. Dust bag                           |   |
| 13. Filter cage            | 27. Foam filter (wet)                  |   |
| 14. Safety float valve     | 28. 2 x covers for fitting the wheels  |   |
|                            | 29. 2 x R-clips for fitting the wheels |   |

## TABLE OF CONTENTS

SPECIFICATIONS.....	Page 02
KNOW YOUR PRODUCT.....	Page 02
INTRODUCTION.....	Page 05
SAFETY INSTRUCTIONS.....	Page 05
ASSEMBLY.....	Page 09
SUCTION TOOLS.....	Page 12
OPERATION.....	Page 13
MAINTENANCE.....	Page 15
DESCRIPTION OF SYMBOLS.....	Page 16
CONTENTS.....	Page 17
WARRANTY.....	Page 20

## INTRODUCTION

Congratulations on purchasing a Full Boar wet and dry vac.

It has been designed for wet and dry vacuuming using the appropriate filter. The appliance is not suitable for the vacuuming of combustible, explosive or harmful substances.

## SAFETY INSTRUCTIONS



**WARNING!** When using mains-powered equipment, basic safety precautions, including the following, should always be followed to reduce risk of fire, electric shock, personal injury and material damage.

Read and understand the manual prior to operating this appliance.

Save these instructions and other documents supplied with this appliance for future reference.

## ELECTRICAL SAFETY

Read the whole manual carefully and make sure you know how to switch the appliance off in an emergency, before operating.

Save these instructions and other documents supplied with this appliance for future reference.

Before you connect the equipment to the mains supply make sure that the data on the rating plate is identical to the mains data.

If the supply cord is damaged, it must be replaced by an electrician or an appliance service centre, in order to avoid a hazard.

### Using an extension lead

Always use an approved extension lead suitable for the power input of this appliance. Before use, inspect the extension lead for signs of damage, wear and ageing. Replace the extension lead if damaged or defective. When using an extension lead on a reel, always unwind the lead completely. Use of an extension lead not suitable for the power input of the appliance, or which is damaged or defective may result in a risk of fire and electric shock.

## GENERAL SAFETY WARNINGS

### SAVE THESE INSTRUCTIONS

- Important: Read the operating instructions before assembling and using the appliance for the first time.
- Check that the mains voltage is the same as the mains voltage specified on the rating plate.
- Pull out the power plug in the following circumstances: Whenever the appliance is not in use, before opening the appliance and before all cleaning and maintenance work.
- Never clean the appliance with solvents.
- Never pull the plug out of the socket by pulling the cable.
- Never leave the appliance unattended when operational.
- Keep away from children.
- Take care to ensure that the power cable does not get damaged by being run over, crushed, pulled or suchlike.
- Do not use the machine if the power cable is in a less than perfect condition.
- If the power cable has to be replaced, the replacement must comply with the design specifications of the manufacturer. Power cable: H 05 VV - F 3 x 1.5 mm<sup>2</sup>.
- Never vacuum the following: Burning matches, smoldering ash and cigarette butts, combustible, caustic, inflammable or explosive substances, vapour or liquids.
- This appliance is not suitable for vacuuming dust which can be harmful to health.
- Store the appliance in a dry indoor location.
- Never use the appliance if it is damaged.
- Only allow the appliance to be serviced by an authorised after sales service outlet.
- Only use the appliance to carry out work for which it has been designed.
- Take extra care when cleaning steps.
- Use only genuine accessories and spare parts.

This appliance is not intended for use by persons (including children) with reduced physical, sensory or mental capabilities, or lack of experience and knowledge, unless they have been given supervision or instruction concerning use of the appliance by a person responsible for their safety. Children should be supervised to ensure that they do not play with the appliance.

## WET AND DRY VACUUM SAFETY WARNINGS



**IMPORTANT!** When using the equipment, a few safety precautions must be observed to avoid injuries and damage. Please read the complete operating manual with due care. Keep this manual in a safe place so that the information is available at all times. If you give the equipment to any other person, give them these operating instructions as well.

The manufacturer cannot accept any liability for damage or accidents which arise due to a failure to follow these instructions and the safety information.

- **Do not leave the appliance unattended when plugged in.** Unplug from the outlet when not in use and before servicing and cleaning.
- **To avoid electric shock, do not expose to rain.** Store indoors.
- **Never use in the presence of explosive liquids, vapours or explosive dust** - such as coal.
- **Never pick up asbestos or asbestos dust.**
- **Wood dust and chips in a confined area can give risk to fire or an explosion.** Guard against possible ignition sources.
- **Do not pick up anything that is burning or smoldering** – such as metal grinding dust, cigarette ends, hot coals, matches or similar.
- **The appliance is not intended for use by young children or infirm persons without supervision.** Young children should be supervised to ensure they do not play with the appliance.
- **Use only manufacturer's recommended attachments and consumables.**
- **Never modify the cleaner in any way** - this is dangerous and will invalidate the warranty.
- **Do not use the appliance without the filter in place.**
- **If the motor sound becomes higher pitched always check for the following:** - a blocked hose or accessory, a blocked filter or a full container.
- **Never try to move the appliance by pulling with the mains lead.**
- **Always check that the filter is clear and not blocked.** Keep all openings clear of any blockages.
- **When lifting the appliance, always lift it with the handle or under the rim of the bucket.**  
Beware of excess weight.
- **Always switch the unit off before changing attachments or connecting different devices.**
- **If the cord is damaged have it repaired by an authorised service centre.**

## WET & DRY VACUUM SAFETY WARNINGS (cont.)

- **This appliance is not intended for use by persons (including children) with reduced physical, sensory or mental capabilities, or lack of experience and knowledge,** unless they have been given supervision or instruction concerning use of the appliance by a person responsible for their safety.
- **Children should be supervised to ensure that they do not play with the appliance.**
- **The equipment is to be used only for its prescribed purpose.** Any other use is deemed to be a case of misuse. The user / operator and not the manufacturer will be liable for any damage or injuries caused as a result of this.

## ASSEMBLY

**WARNING!** During assembly ensure the wet and dry vac is switched OFF and disconnected from the power supply.

### Fitting the wheels (9):

1. Place an R-clip (29) for fitting the wheels through the appropriate hole in the axle (32), (fig. 1).
2. First fit a washer (30) and a wheel (9), then another washer (30) to the axle (32), (fig. 2).
3. Now slide the axle (32) through the guides provided for it on the underside of the tank (8), (fig. 3).

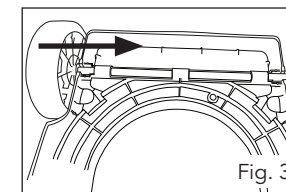
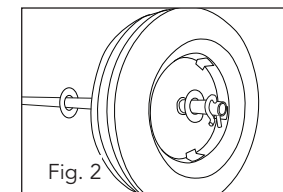
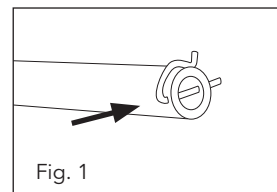

4. Fit a washer (30) and second wheel (9) to the empty end of the axle (32), and secure it with the remaining washer (30) and the R-clip (29).
5. Push the covers (28) on to the outside of the wheels (9) so that the hooks on the covers (28) clip into the slots in the wheel (9), (fig. 4).

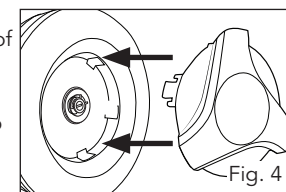

### Fitting the castors (11):

1. Fit the castors (11) into the appropriate mountings on the underside of the tank (8). Push the castors (11) firmly into the mounting until they engage with a clicking noise, (fig. 5).

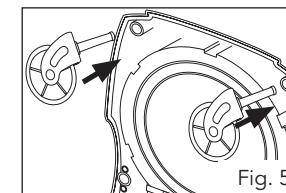

### Fitting the main handle (1):

1. Place the main handle (1) onto handle mounts. Secure in place with bolts (31) and cable hooks (5), (fig. 6).

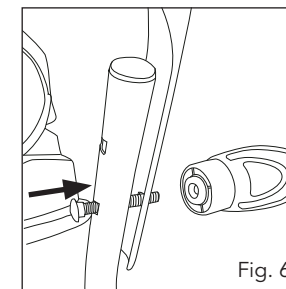

## ASSEMBLY (cont.)

### Fitting the motor head (12):

1. The motor head (12) is fastened to the tank (8) by the motor securing clips (6), (fig. 7).

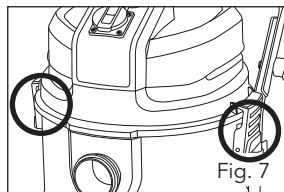

2. To remove the motor head (12), open the securing clips (6), (fig. 8) and lift the motor head (12) by the carry handle (2).

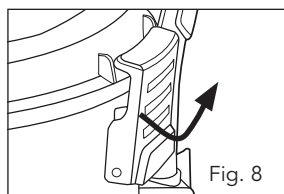

3. When fitting the motor head (12), make sure that the securing clips (6) lock into place correctly.

### Fitting the filter

**!** **IMPORTANT!** Never use the wet and dry vacuum cleaner without a filter. Check that the filter is securely fitted at all times.

### Fitting the foam filter (27) - vacuuming liquid:

1. For wet vacuuming, slip the supplied foam filter (27) over the filter cage (13), (fig. 9).

**Note.** The pleated filter (24), already fitted upon delivery is not suitable for wet vacuuming.

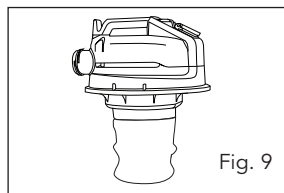

### Fitting the pleated filter (24) - vacuuming dry matter:

1. For dry vacuum cleaning always use the pleated filter. If it is not fitted, slip it over the filter cage (13), (fig. 10). Place the cap (25) on the base of the pleated filter (24), turn in a clockwise direction to lock in position (fig. 11). The pleated filter (24) is suitable for dry-vacuuming only.

**Note:** Do not use the **foam filter (27)** when vacuuming dry mater.

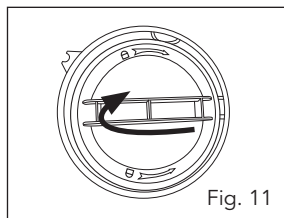
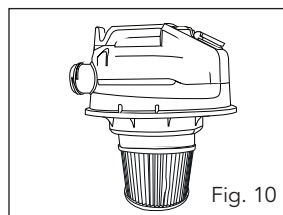

## ASSEMBLY (cont.)

### Fitting the dust bag (26) - vacuuming dry matter:

Place the dust bag (26) inside the tank (8), then slip the opening over the vacuum inlet, (fig. 12).

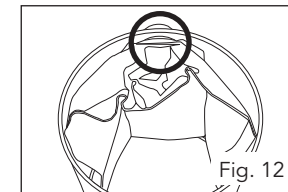

### Fitting the suction hose (33):

Connect the suction hose (33) to the corresponding connector on the wet and dry vacuum cleaner, depending on the application required.

### Vacuuming

Connect the suction hose (33) to the suction hose connector (7), (fig. 13).

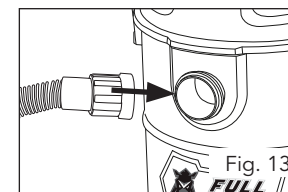

### Blowing

Connect the suction hose (33) to the blow connector (15), (fig. 14).

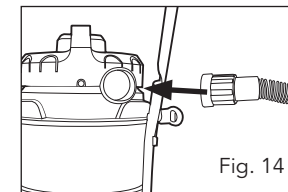

### Air regulator (23):

The air regulator (23) on the tube handle (18) can be fitted between the suction hose (33) and the suction tube (17), (fig. 15). The suction power of the nozzle can be adjusted by using the air regulator (23).

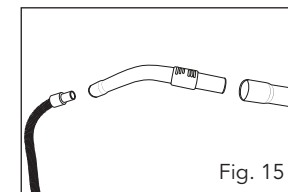

When wet vacuuming, make selective use of the air regulator to suck in air as well as liquids. This will help to take some strain off the equipment when vacuuming liquids.

## SUCTION TOOLS

### Floor tool (21):

The floor tool (21) is for vacuuming solids and liquids over medium to large areas (fig. 16).

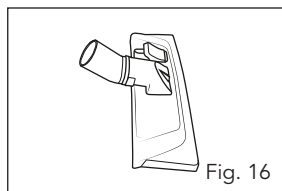

Fig. 16

### Crevice tool (20):

The crevice tool (20) is designed for vacuuming solids and liquids in corners, edges and other areas that are difficult to access (fig. 17).

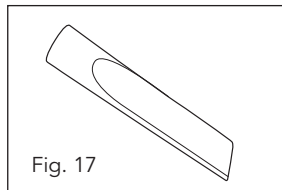

Fig. 17

### Upholstery tool (22):

The upholstery tool (22) is specially designed for vacuuming solids on upholstery and carpets (fig. 18).

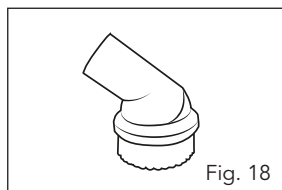

Fig. 18

## OPERATION

**This vacuum must be used with a residual current device with a rated residual current of 30mA or less.**

### ON/OFF/AUTO switch (3) (fig. 19)

Switch position 0: Off

Switch position I: Normal operation

Switch position AUTO: Automatic mode

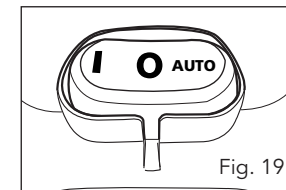

Fig. 19

### Dry vacuuming (fig. 20 & 21)

Use the pleated filter (24) for dry vacuuming (see **Fitting the pleated filter**).

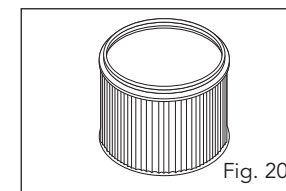

Fig. 20

The dust bag (26) can also be fitted for removal of particularly heavy dirt (see **Fitting the dust bag**).

Always ensure that the filters are perfectly secure.

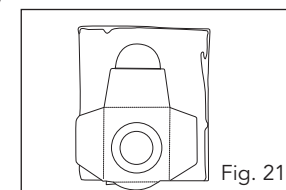

Fig. 21

### Wet vacuuming (fig. 22)

For wet-vacuuming, use the foam filter (27), (see **Fitting the foam filter**).

Check that the filter is securely fitted at all times.

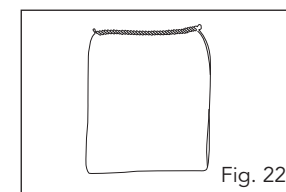

Fig. 22

### Water drain outlet (10)

To make the tank (8) easier to empty after wet vacuuming, it is fitted with a water drain outlet (10).

Open the water drain outlet (10) by turning it anti-clockwise (fig. 23) and drain the liquid.

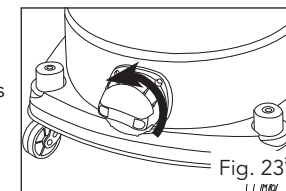

Fig. 23

**! IMPORTANT!** When wet vacuuming, the floating safety valve (14) turns off the wet and dry vacuum cleaner automatically when the maximum level is reached.

**! IMPORTANT!** The wet and dry vacuum cleaner is not suitable for the vacuuming of combustible liquids. For wet vacuuming, use only the supplied foam filter.

## OPERATION (cont.)

### Automatic mode (1450W max.)

Connect the power cable on your device to the automatic power outlet (4) and connect the suction hose (33) to the extractor connector on your device (fig. 24). Check that the connections are secure and airtight.

You can use the supplied hose adaptor (19) to connect the suction hose (33) to the device. To do so, fit it between the suction hose and the extractor port on the device.

Set the switch (3) on the wet and dry vacuum cleaner to position AUTO, automatic mode (fig. 25). The moment you switch on the device, the wet and dry vacuum cleaner switches on as well. When you switch off the device, the wet and dry vacuum cleaner switches off as well, after a preset delay.

### Blowing

Connect the suction hose (33) to the blow connector (15) on the wet and dry vacuum cleaner (fig. 26).

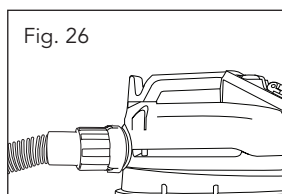
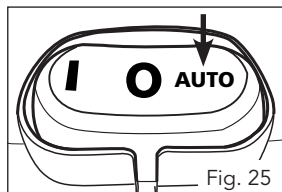
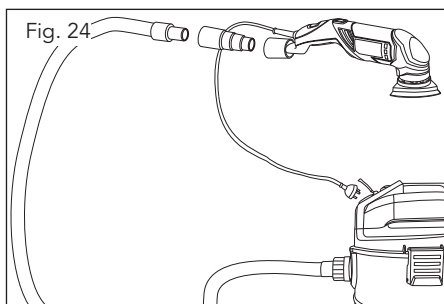

## MAINTENANCE



**IMPORTANT!** Before cleaning your wet & dry vac or carrying out any maintenance procedures, make sure that the motor is off and the vac is disconnected from the power supply to prevent accidental starting.

### Cleaning

Keep all safety devices, air vents and the motor housing free of dirt and dust as much as possible.

We recommend that you clean the appliance immediately after you use it.

### Cleaning the motor head (12)

Clean the appliance regularly with a damp cloth and some liquid soap. Do not use cleaning agents or solvents; these may be aggressive to the plastic parts in the appliance.

### Cleaning the tank (8)

The container can be cleaned with a damp cloth and some liquid soap or under running water, depending on the amount of dirt.

### Cleaning the filters

#### Cleaning the pleated filter (24)

Clean the pleated filter (24) regularly by carefully patting it and cleaning it with a fine brush or hand brush.

#### Cleaning the foam filter (27)



Clean the foam filter (27) with a little liquid soap under running water and allow it to air-dry.

### Maintenance

At regular intervals and before each use, check that the filters in the wet and dry vacuum cleaner are securely fitted.



## DESCRIPTION OF SYMBOLS

<b>V</b>	Volts	<b>Hz</b>	Hertz
~	Alternating current	<b>W</b>	Watts
<b>/min</b>	Revolutions or reciprocation per minute	<b>n<sub>o</sub></b>	No load speed
l	Litres		Regulator compliance mark
	Read instruction manual		Warning
<b>IP24</b>	Ingress protection from water	<b>mbar</b>	Pressure rating (millibar)

## CONTENTS

1 x FBWDV-40PTU Wet & dry vac  
 1 x Main handle  
 2 x Wheels  
 2 x Castors  
 2 x Wheel covers  
 2 x Securing R-clips for wheels  
 4 x Washers for fitting the wheels  
 1 x Axle  
 2 x Bolts for fitting the main handle  
 2 x Cable hooks  
 1 x Suction tube  
 1 x Tube handle (air regulator)  
 1 x Hose adaptor  
 1 x Crevice tool  
 1 x Upholstery tool  
 1 x Floor tool  
 1 x Pleated filter  
 1 x Cap for pleated filter  
 1 x Dust bag  
 1 x Foam filter  
 1 x Suction hose  
 1 x Instruction manual



# WARRANTY

All of our products undergo strict quality checks to ensure that they reach you in perfect condition. In the unlikely event that your appliance develops a fault, please contact our service department at the address shown on this guarantee card. You can also contact us by telephone using the customer service number shown. Please note the following terms under which guarantee claims can be made:

1. These warranty terms regulate additional warranty services, which the manufacturer (mentioned below) promises to buyers of its new products. In addition to their statutory guarantee, claims are not affected by this guarantee. Our guarantee is free of charge to you.
2. The warranty services only cover defects due to material or manufacturing faults on this product which you have bought from the manufacturer (mentioned below) and are limited to either the rectification of said defects on the product or the replacement of the product, whichever we prefer.
3. The following are not covered by our guarantee:
  - Damage to the appliance caused by a failure to follow the assembly instructions or due to incorrect installation; a failure to follow the operating instructions (for example, connecting it to an incorrect mains voltage or current type) or a failure to follow the maintenance and safety instructions; or by exposing the appliance to abnormal environmental conditions, or by lack of care and maintenance.
  - Damage to the appliance caused by abuse or incorrect use (for example, overloading the appliance, or the use of unapproved tools or accessories), ingress of foreign bodies into the appliance (such as sand, stones or dust, transport damage), the use of force or damage caused by external forces (for example, by dropping it).
  - Damage to the appliance or parts of the appliance caused by normal or natural wear or tear, or by normal use of the appliance.
4. Your product is guaranteed for a period of 12 months from the original date of purchase. Warranty excludes consumable parts. Guarantee claims should be submitted before the end of the guarantee period and within two weeks of the defect being noticed. No guarantee claims will be accepted after the end of the guarantee period. The original guarantee period remains applicable to the appliance even if repairs are carried out or parts are replaced. In such cases, the work performed or parts fitted will not result in an extension of the guarantee period, and no new guarantee will become active for the work performed or parts fitted. This also applies if an on-site service is used.

Your statutory rights remain unaffected, in particular, any rights you have under the Consumer Rights Act 2015.

**IN ORDER TO MAKE A CLAIM UNDER THIS WARRANTY, YOU MUST RETURN THE PRODUCT TO THE PLACE OF PURCHASE WITH YOUR RECEIPT.**

Please refer to the restrictions of this warranty concerning wearing parts, consumables and missing parts, as set out in the service information in these operating instructions.

**CUSTOMER SERVICE HELPLINE**

GB: 0151 294 4488

IRL: 1850 882711

**OZITO UK**

Unit 9 Stadium Court, Wirral International Business Park, Plantation Road,  
Bromborough, Wirral, CH62 3QG