

# ozito

## PLUNGE PRO™

**600W**

### INSTRUCTION MANUAL

### SPECIFICATIONS

Motor:	600W
Rated Speed:	6000/min
Blade Diameter:	89mm
Max Cut:	28.5mm 23mm with base
Weight:	2kg

[ozito.com.au](http://ozito.com.au)

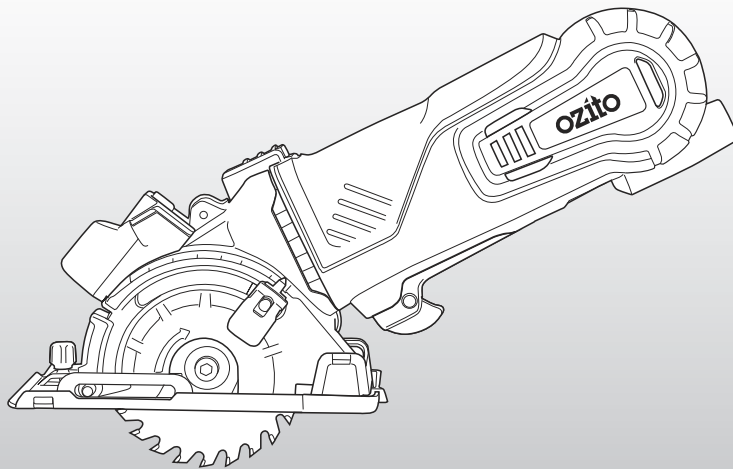

### WHAT'S IN THE BOX

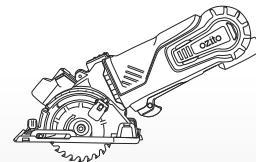

**Mini Plunge Cutter**

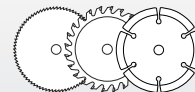

**Blades x 3**

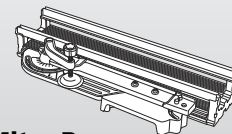

**Mitre Base**

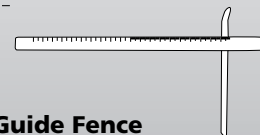

**Guide Fence**

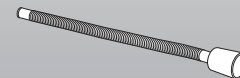

**Vacuum Adaptor**

**3** YEAR REPLACEMENT WARRANTY

PCR-2100

# KNOW YOUR PRODUCT

## MINI PLUNGE CUTTER

- |                            |                         |
|----------------------------|-------------------------|
| 1 Guide Fence Locking Knob | 5 Plunge Release Button |
| 2 Laser                    | 6 Lock-off Trigger      |
| 3 Laser On/off Switch      | 7 Sure Grip Body        |
| 4 Cutting Depth Clamp      | 8 Power Indicator Light |

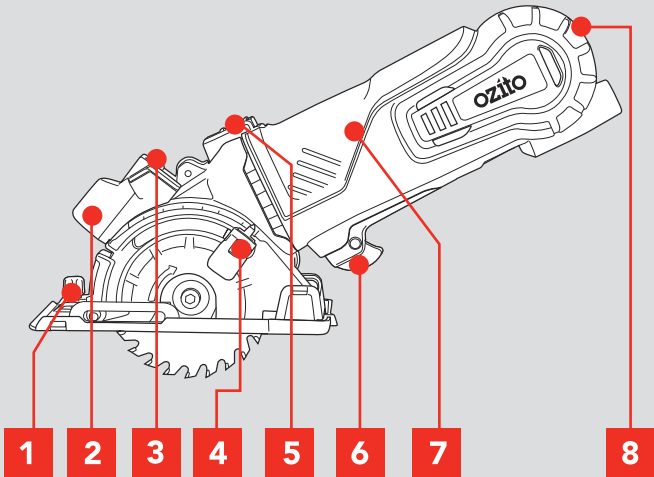

## ACCESSORIES

- |                            |                  |
|----------------------------|------------------|
| 9 Mitre Angle Scale & Base | 15 Diamond Blade |
| 10 Clamp                   | 16 TCT Blade     |
| 11 Fence Locking Lever     | 17 HSS Blade     |
| 12 Extension Base          | 18 Guide Fence   |
| 13 Extendable Fence        | 19 Hex Key       |
| 14 Vacuum Adaptor          |                  |

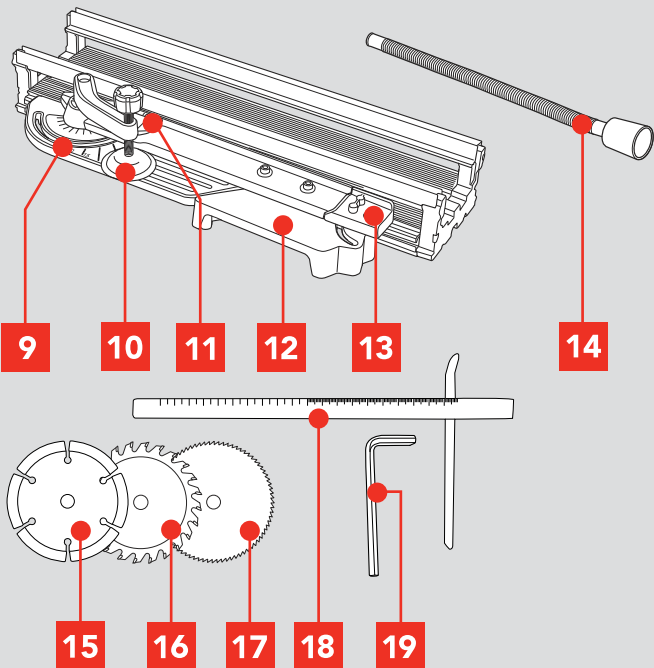

## ONLINE MANUAL

Scan this QR Code with your mobile device to take you to the online manual.



# SETUP & PREPARATION

## 1. CHANGING BLADES

Ensure the tool is disconnected from the power supply before performing any of the following operations.

1. Set cutting depth to maximum.

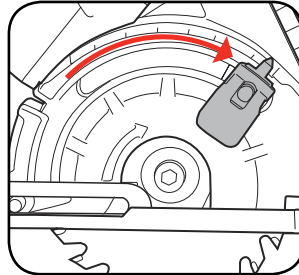

2. Press and hold the spindle lock button.

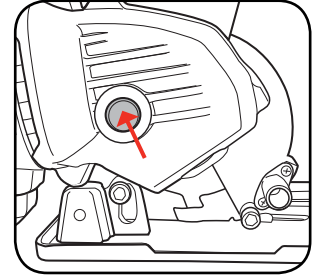

3. Use hex key to loosen & remove the clamping screw.

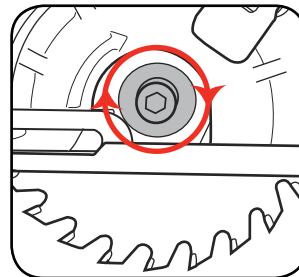

4. Press plunge release button to lift up the base plate.

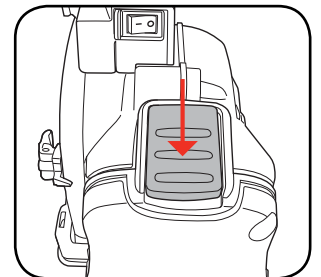

5. Lift blade up off spindle then pull from the tool to remove blade.

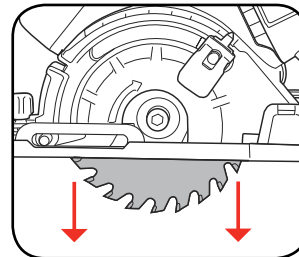

6. Install the new saw blade.

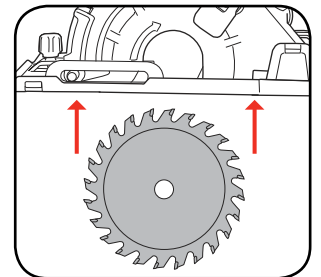

7. Press the spindle lock button and tighten the clamping screw.

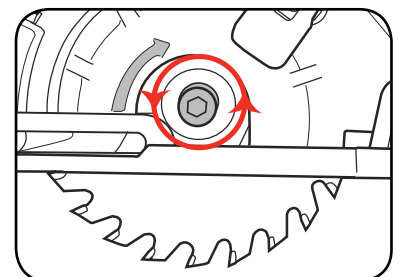

**Note:** The arrow on the saw blade must match the arrow showing direction of rotation on the guard.

**3** YEAR REPLACEMENT WARRANTY

## 2. FITTING ATTACHEMENTS

### Guide Fence

1. Ensure the guide fence locking knob is loose.
2. Slide the guide fence through the holes in the base plate.

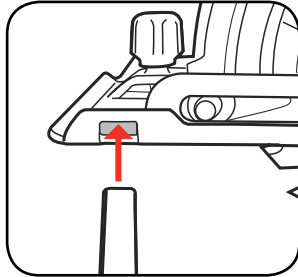
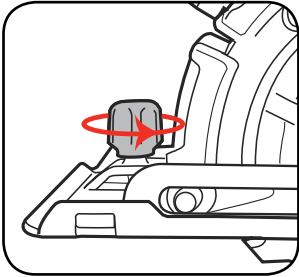

3. Tighten the guide fence locking knob to secure in place.

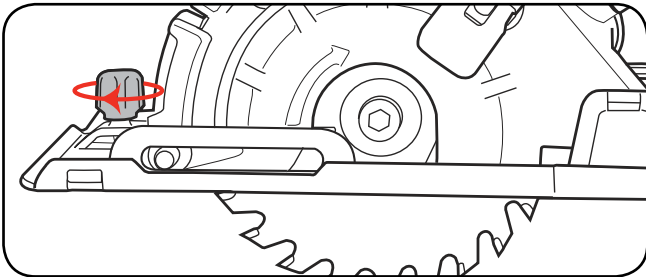

### Vacuum Adaptor

A vacuum adaptor hose has been supplied with the tool. When used correctly it can help remove dust, chips and cutting debris away from the cutting area.

1. Connect the small end of the vacuum adaptor to the dust extraction port on the tool.

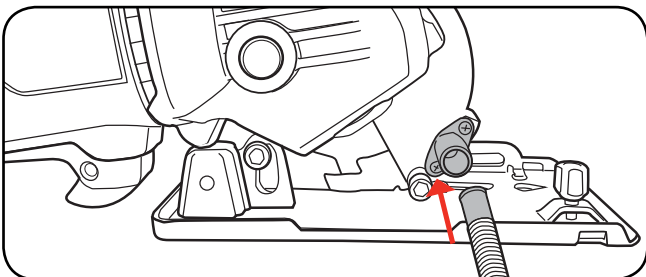

2. Connect the other end of the vacuum adaptor to the end of a vacuum hose.

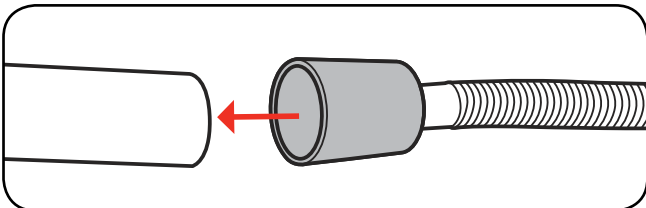

3. Leave the vacuum switched on while cutting.

## 3. SETTING UP THE CUT

### Depth of Cut

1. Release the cutting depth clamp.
2. Move indicator to the desired depth of cut.

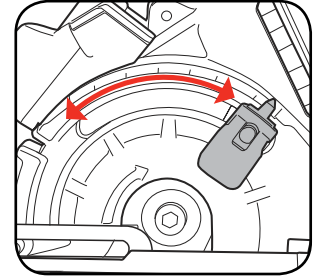
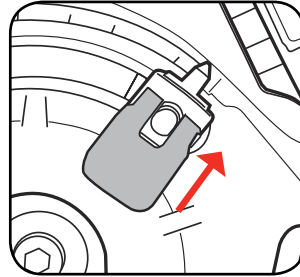

3. Lock the cutting depth clamp to secure depth of cut.

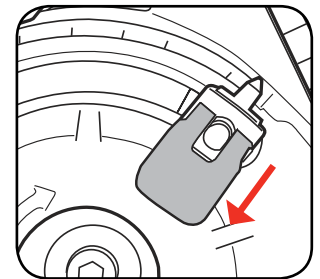

### Laser

**WARNING!** Do not stare directly at the laser beam

The laser can be used as a cutting line to increase cutting accuracy.

1. To turn the laser on, push the laser on/off switch to the "I" position.

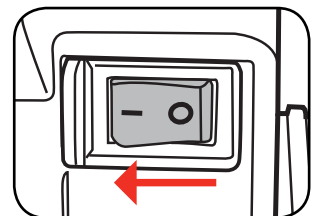

2. Line the laser up with cutting marks on your workpiece.

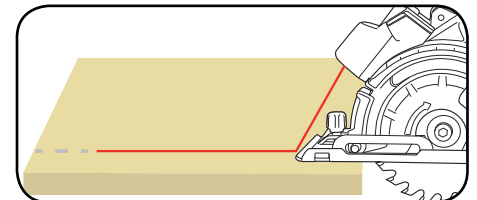

3. To turn off, push the laser on/off switch to the "O" position.

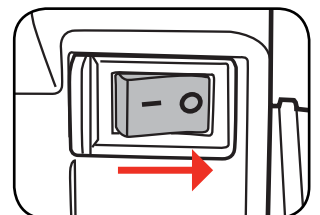

# OPERATION

## 4. CONTROLS

The tool is recommended for use with a residual current device with a rated residual current of 30mA or less.

### Lock-off Switch

1. To turn on, push and hold the lock off lever forward.
2. Squeeze the on/off trigger.

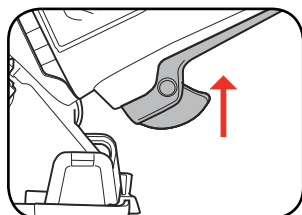
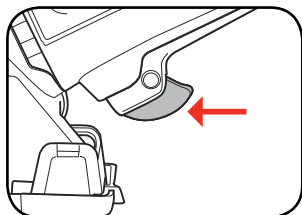

3. To turn off, release the on/off trigger.

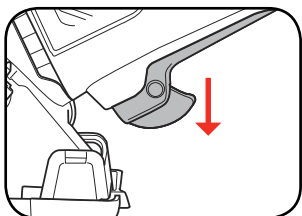

### Plunge Release

1. With the base flat on the workpiece, press and hold the plunge release button.

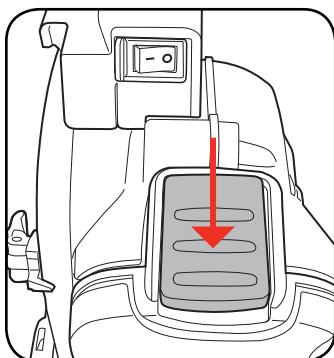

2. Raise the body of the mini plunge cutter, plunging the blade into the workpiece.

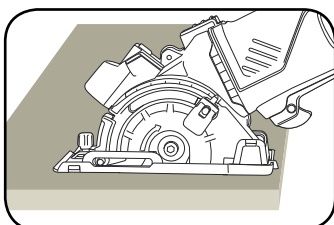

## 5. OPERATING THE PLUNGE CUTTER

1. Ensure the cutting depth is set and locked to the desired depth.

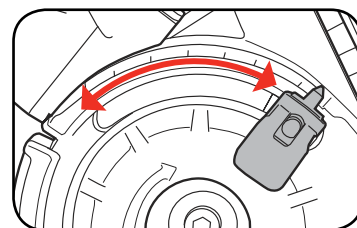

2. Place the base of mini plunge cutter flat on the workpiece.

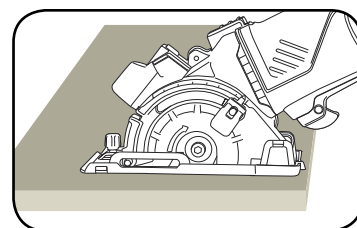

3. Turn the mini plunge cutter on.

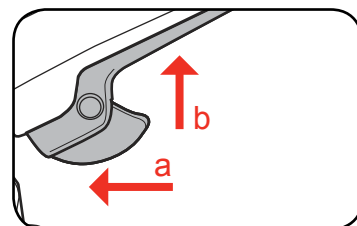

4. Press the plunge lock lever to start the cut.

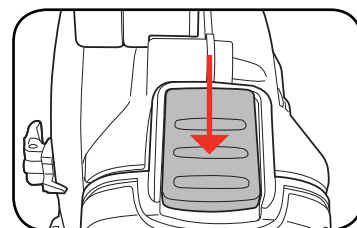

5. Use a light, continuous pressure to complete the cut.

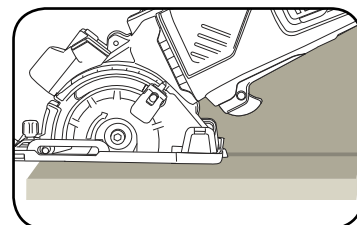

**Caution:** OVERHEATING A SAW BLADE CAN CAUSE IT TO WARP AND RESULT IN A KICKBACK.

## 6. MITRE BASE

The mitre base is used to make precise, mitred cuts.

1. Release the fence locking lever by pulling up.

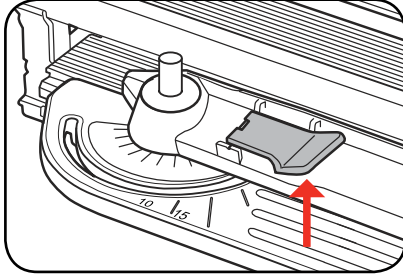

2. To set the mitre angle, slide the extendable fence along the mitre angle scale.

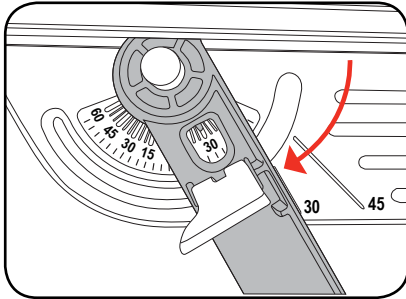

3. Line the notch indicator up to your desired angle on the mitre angle scale.

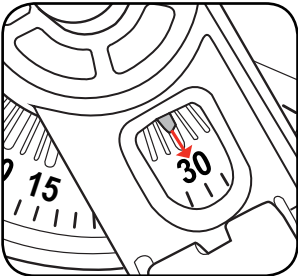

4. Push down the fence locking lever to secure angle.

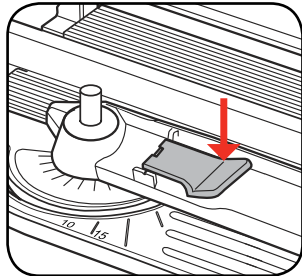

5. Insert the workpiece and secure into place with the clamp.

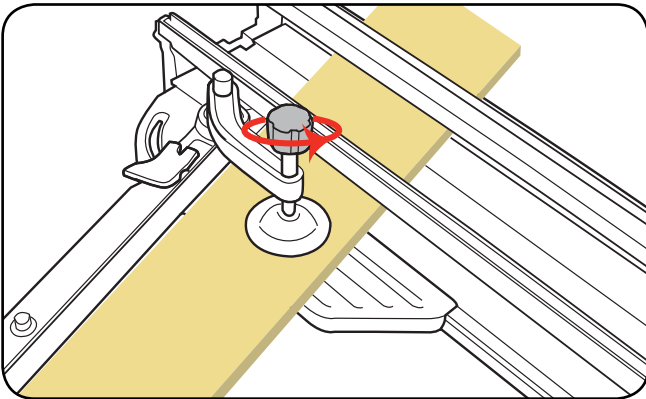

**Note:** the mini plunge cutter on the two inner tracks of the mitre base.

## 7. MITRE BASE ADJUSTMENTS

1. The fence length can be extended to suit the length of working material.

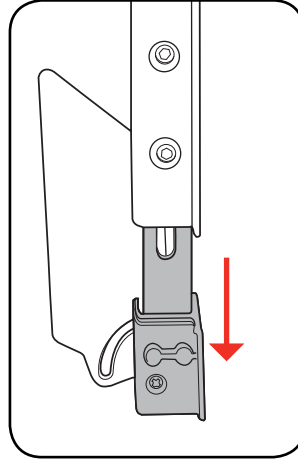

2. Flip the extension base out to support longer work pieces.

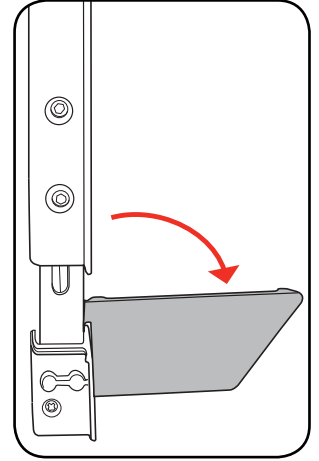

### Repositioning the Mitre Angle Scale and Base

For increased versatility, the mitre angle scale and base can be fitted to either side of the track and positioned anywhere along the length of the track.

1. Unscrew the mitre scale fixing knob on the underside of the mitre base.

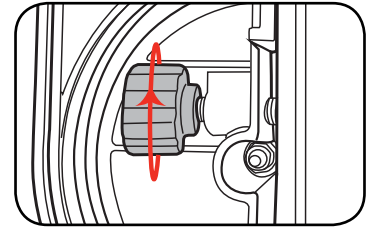



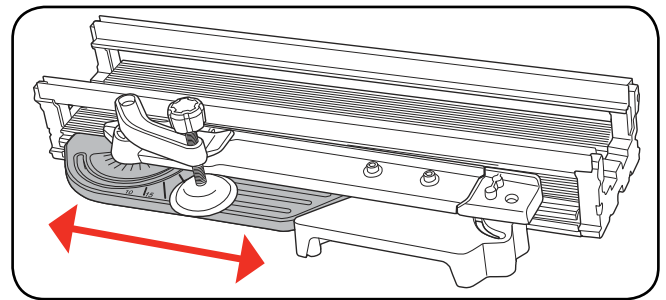

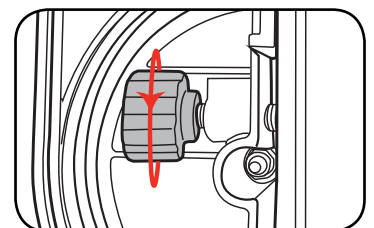

2. Slide the mitre scale and base along the track to desired position.



3. Fasten the mitre scale fixing knob to secure position.



# DESCRIPTION OF SYMBOLS

<b>V</b>	Volts	<b>Hz</b>	Hertz
<b>~</b>	Alternating current	<b>W</b>	Watts
<b>/min</b>	Revolutions or reciprocation per minute	<b>n</b>	Max rated speed
	Double insulated		Regulator compliance mark
<b>∅</b>	Diameter	<b>m/s</b>	Meters per second
<b>nm</b>	Nanometers	<b>mW</b>	Milliwatts
	Warning		Read instruction manual
	Wear eye protection		Wear gloves
	Wear ear, eye and respiratory protection		

# BLADE SELECTION

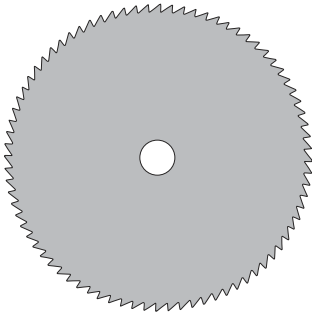

**HSS Blade**

Suitable only for cutting aluminium

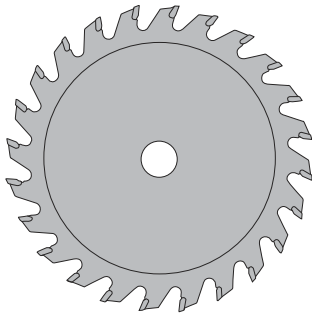

**TCT Blade**

Suitable only for cutting timber

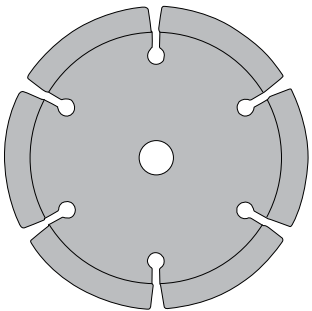

**Diamond Blade**

Suitable only for cutting masonry

# MAINTENANCE

- If the supply cord of this power tool is damaged, it must be replaced by a specially prepared cord available through the service organisation.
- Keep the ventilation vents of the plunge cutter clean at all times, if possible, prevent foreign matter from entering the vents.
- After each use, blow air through the plunge cutter housing to ensure it is free from all dust particles which may build up. Build up of dust particles may cause the plunge cutter to overheat and fail.
- If the enclosure of the plunge cutter requires cleaning, do not use solvents but a moist soft cloth only. Never let any liquid get inside the plunge cutter; never immerse any part of the plunge cutter into a liquid.

## Carbon Brushes

When the carbon brushes wear out, the plunge cutter will spark and/or stop. Discontinue use as soon as this happens. They should be replaced prior to recommencing use of the plunge cutter. Carbon brushes are a wearing component of the plunge cutter therefore not covered under warranty. Continuing to use the plunge cutter when carbon brushes need to be replaced may cause permanent damage to the plunge cutter. Carbon brushes will wear out after many uses but when the carbon brushes need to be replaced, take the plunge cutter to an electrician or a power tool repairer for a quick and low cost replacement. Always replace both carbon brushes at the same time.



*Note: Ozito Industries will not be responsible for any damage or injuries caused by the repair of the plunge cutter by an unauthorised person or by mishandling of the plunge cutter.*

# TROUBLESHOOTING

## Sparking visible through the housing air vents

A small amount of sparking may be visible through the housing vents. This is normal and does not indicate a problem.

## Excessive sparking visible through the housing air vents and/or the plunge cutter failing to operate



May indicate the carbon brushes have worn out and need to be replaced. Carbon brushes should only be replaced by a qualified electrician or power tool repairer.

# SPARE PARTS

Vacuum Adaptor	SPPCR2100-12
Carbon Brush (pair)	SPPCR2100-38
Power Switch	SPPCR2100-64
Base Plate	SPPCR2100-89
Guide Fence	SPPCR2100-93
Laser Assembly	SPPCR2100-508A

**Spare parts can be ordered from the Special Orders Desk at your local Bunnings Warehouse.**

**For further information, or any parts not listed here, visit [www.ozito.com.au](http://www.ozito.com.au) or contact Ozito Customer Service:**

**Australia 1800 069 486**

**New Zealand 0508 069 486**

**E-mail: [enquires@ozito.com.au](mailto:enquires@ozito.com.au)**

# CARING FOR THE ENVIRONMENT



Power tools that are no longer usable should not be disposed of with household waste but in an environmentally friendly way. Please recycle where facilities exist. Check with your local council authority for recycling advice.



Recycling packaging reduces the need for landfill and raw materials. Reuse of recycled material decreases pollution in the environment. Please recycle packaging where facilities exist. Check with your local council authority for recycling advice.



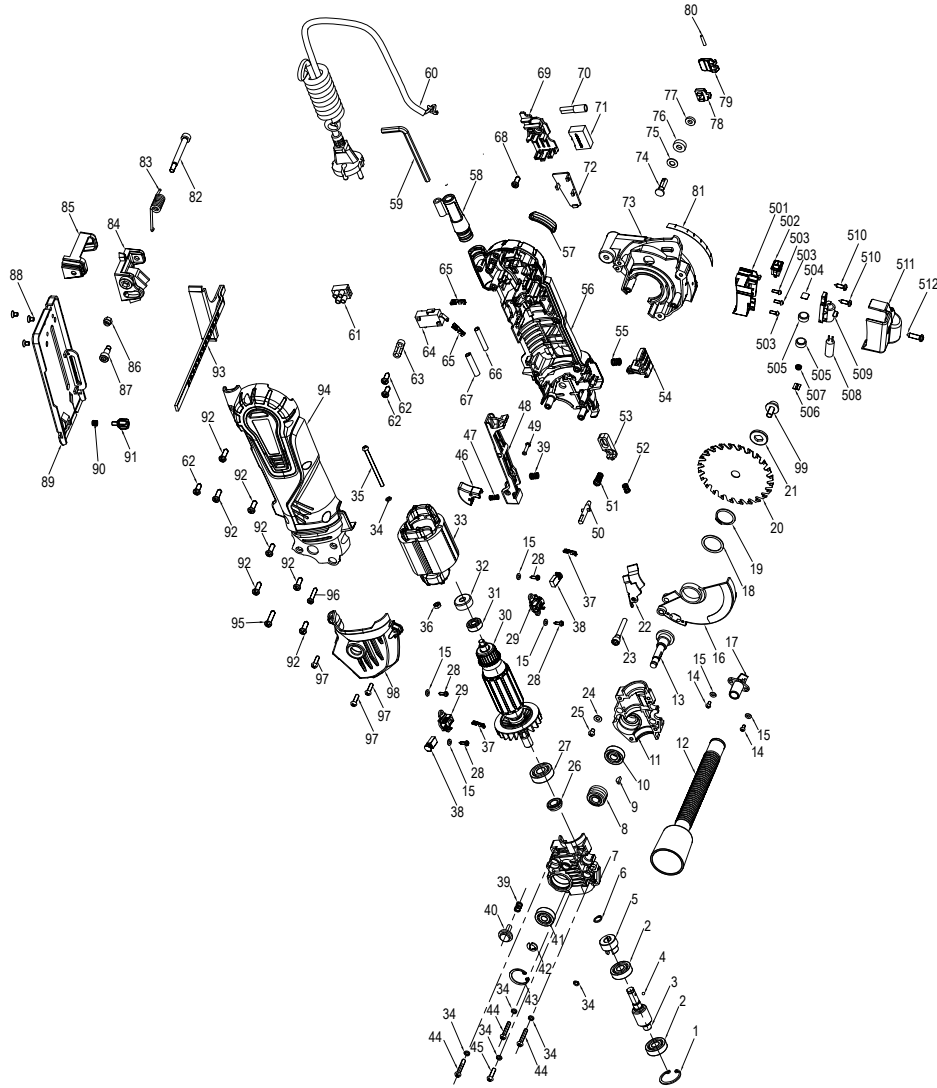

The following is a list of spare parts carried by Ozito.  
Please contact Customer Service for any parts not listed.

Item No.	Description	Part No.	Item No.	Description	Part No.
12	Vacuum Adaptor	SPPCR2100-12			
38	Carbon Brush (pair)	SPPCR2100-38			
64	Power Switch	SPPCR2100-64			
89	Base Plate	SPPCR2100-89			
93	Guide Fence	SPPCR2100-93			
508A	Laser Assembly	SPPCR2100-508A			

## How To Order

Available spare parts can be ordered through the Special Orders Desk at any Bunnings Warehouse. If you have any further questions, please contact Ozito Customer Service on:

Australia: 1800 069 486

New Zealand: 0508 069 486

enquiries@ozito.com.au



# PLUNGE CUTTER SAFETY WARNINGS



**DANGER:** a) Keep hands away from cutting area and the blade. Keep your second hand on auxiliary handle, or motor housing. If both hands are holding the saw, they cannot be cut by the blade.

b) Do not reach underneath the workpiece. The guard cannot protect you from the blade below the workpiece.

c) Adjust the cutting depth to the thickness of the workpiece. Less than a full tooth of the blade teeth should be visible below the workpiece.

d) Never hold piece being cut in your hands or across your leg. Secure the workpiece to a stable platform. It is important to support the work properly to minimize body exposure, blade binding, or loss of control.

e) Hold power tool by insulated gripping surfaces when performing an operation where the cutting tool may contact hidden wiring or its own cord. Contact with a "live" wire will also make exposed metal parts of the power tool "live" and shock the operator.

f) When ripping always use a rip fence or straight edge guide. This improves the accuracy of cut and reduces the chance of blade binding.

g) Always use blades with correct size and shape (diamond versus round) of arbour holes. Blades that do not match the mounting hardware of the saw will run eccentrically, causing loss of control.

h) Never use damaged or incorrect blade washers or bolt. The blade washers and bolt were specially designed for your saw, for optimum performance and safety of operation.

## Further safety instructions for all saws

### Causes and operator prevention of kickback:

• Kickback is a sudden reaction to a pinched, bound or misaligned saw blade, causing an uncontrolled saw to lift up and out of the workpiece toward the operator;

• When the blade is pinched or bound tightly by the kerf closing down, the blade stalls and the motor reaction drives the unit rapidly back toward the operator;

• If the blade becomes twisted or misaligned in the cut, the teeth at the back edge of the blade can dig into the top surface of the wood causing the blade to climb out of the kerf and jump back toward the operator.

Kickback is the result of saw misuse and/or incorrect operating procedures or conditions and can be avoided by taking proper precautions as given below.

a) Maintain a firm grip with both hands on the saw and position your arms to resist kickback forces. Position your body to either side of the blade, but not in line with the blade. Kickback could cause the saw to jump backwards, but kickback forces can be controlled by the operator, if proper precautions are taken.

b) When blade is binding, or when interrupting a cut for any reason, release the trigger and hold the saw motionless in the material until the blade comes to a complete stop. Never attempt to remove the saw from the work or pull the saw backward while the blade is in motion or kickback may occur. Investigate and take corrective actions to eliminate the cause of blade binding.

c) When restarting a saw in the workpiece, centre the saw blade in the kerf and check that saw teeth are not engaged into the material. If saw blade is binding, it may walk up or kickback from the workpiece as the saw is restarted.

d) Support large panels to minimise the risk of blade pinching and kickback. Large panels tend to sag under their own weight. Supports must be placed under the panel on both sides, near the line of cut and near the edge of the panel.

e) Do not use dull or damaged blades. Blunt or improperly set blades produce narrow kerf causing excessive friction, blade binding and kickback.

f) Blade depth and bevel adjusting locking levers must be tight and secure before making cut. If blade adjustment shifts while cutting, it may cause binding and kickback.

g) Use extra caution when making a "plunge cut" into existing walls or other blind areas. The protruding blade may cut objects that can cause kickback.

## Safety instructions for plunge cut circular saws

a) Check guard for proper closing before each use. Do not operate the saw if guard does not move freely and enclose the blade instantly. Never clamp or tie the guard with the blade exposed. If saw is accidentally dropped, guard may be bent. Check to make sure that guard moves freely and does not touch the blade or any other part, in all angles and depths of cut.

b) Check the operation and condition of the guard return spring. If the guard and the spring are not operating properly, they must be serviced before use. Guard may operate sluggishly due to damaged parts, gummy deposits, or a build-up of debris.

c) Assure that the guide plate of the saw will not shift while performing the "plunge cut" when the blade bevel setting is not at 90°. Blade shifting sideways will cause binding and likely kick back.

d) Always observe that the guard is covering the blade before placing saw down on bench or floor. An unprotected, coasting blade will cause the saw to walk backwards, cutting whatever is in its path. Be aware of the time it takes for the blade to stop after switch is released.

## Additional safety instructions for plunge type saws

• Wear ear protectors. Exposure to noise can cause hearing loss.

• Wear a dust mask. Exposure to dust particles can cause breathing difficulty and possible injury.

• Do not use blades of larger or smaller diameter than recommended. For the proper blade rating refer to the technical data. Use only the blades specified in this manual, complying with EN 847-1.

• Never use abrasive cut-off wheels. Residual risks

• In spite of the application of the relevant safety regulations and the implementation of safety devices, certain residual risks cannot be avoided.

These are:

– Impairment of hearing.

– Risk of accidents caused by the uncovered parts of the rotating cutting disc.

– Risk of injury when changing the disc.

– Risk of dust inhalation from materials that when cut, can be harmful.

## Replacing cables or plugs

If the mains cable becomes damaged, it must be replaced with a special mains cable available from the manufacturer or the manufacturer's customer service. Dispose of old cables or plugs immediately after replacing them with new ones. It is dangerous to connect the plug of a loose cable to a socket.

## Using extension cables

Only use an approved extension cable suitable for the power input of the machine. The minimum conductor size is 1.5 mm<sup>2</sup>. When using a cable reel always unwind the reel completely.

## Safety instructions for abrasive cutting-off operations

a) The guard provided with the tool must be securely attached to the power tool and positioned for maximum safety, so the least amount of wheel is exposed towards the operator. Position yourself and bystanders away from the plane of the rotating wheel. The guard helps to protect operator from broken wheel fragments and accidental contact with wheel.

b) Use only bonded reinforced or diamond cut-off wheels for your power tool. Just because an accessory can be attached to your power tool, it does not assure safe operation.

c) The rated speed of the accessory must be at least equal to the maximum speed marked on the power tool. Accessories running faster than their rated speed can break and fly apart.

d) Wheels must be used only for recommended applications. For example: do not grind with the

side of cut-off wheel. Abrasive cut-off wheels are intended for peripheral grinding, side forces applied to these wheels may cause them to shatter.

e) Always use undamaged wheel flanges that are of correct diameter for your selected wheel. Proper wheel flanges support the wheel thus reducing the possibility of wheel breakage.

f) Do not use worn down reinforced wheels from larger power tools. Wheels intended for a larger power tool are not suitable for the higher speed of a smaller tool and may burst.

g) The outside diameter and the thickness of your accessory must be within the capacity rating of your power tool. Incorrectly sized accessories cannot be adequately guarded or controlled.

h) The arbour size of wheels and flanges must properly fit the spindle of the power tool. Wheels and flanges with arbour holes that do not match the mounting hardware of the power tool will run out of balance, vibrate excessively and may cause loss of control.

i) Do not use damaged wheels. Before each use, inspect the wheels for chips and cracks. If power tool or wheel is dropped, inspect for damage or install an undamaged wheel. After inspecting and installing the wheel, position yourself and bystanders away from the plane of the rotating wheel and run the power tool at maximum no load speed for one minute. Damaged wheels will normally break apart during this test time.

j) Wear personal protective equipment. Depending on application, use face shield, safety goggles or safety glasses. As appropriate, wear dust mask, hearing protectors, gloves and shop apron capable of stopping small abrasive or workpiece fragments. The eye protection must be capable of stopping flying debris generated by various operations. The dust mask or respirator must be capable of filtering particles generated by your operation. Prolonged exposure to high intensity noise may cause hearing loss.

k) Keep bystanders a safe distance away from work area. Anyone entering the work area must wear personal protective equipment. Fragments of workpiece or of a broken wheel may fly away and cause injury beyond immediate area of operation.

l) Hold the power tool by insulated gripping surfaces only, when performing an operation where the cutting accessory may contact hidden wiring or its own cord. Cutting accessory contacting a "live" wire may make exposed metal parts of the power tool "live" and could give the operator an electric shock.

m) Position the cord clear of the spinning accessory. If you lose control, the cord may be cut or snagged and your hand or arm may be pulled into the spinning wheel.

n) Never lay the power tool down until the accessory has come to a complete stop. The spinning wheel may grab the surface and pull the power tool out of your control.

o) Do not run the power tool while carrying it at your side. Accidental contact with the spinning accessory could snag your clothing, pulling the accessory into your body.

p) Regularly clean the power tool's air vents. The motor's fan will draw the dust inside the housing and excessive accumulation of powdered metal may cause electrical hazards.

q) Do not operate the power tool near flammable materials. Sparks could ignite these materials.

r) Do not use accessories that require liquid coolants. Using water or other liquid coolants may result in electrocution or shock.

## Further safety instructions for abrasive cutting-off operations

### Kickback and related warnings

Kickback is a sudden reaction to a pinched or snagged rotating wheel. Pinching or snagging causes rapid stalling of the rotating wheel which in turn causes the uncontrolled power tool to be forced in the direction opposite of the wheel's rotation at the point of the binding.

For example, if an abrasive wheel is snagged or pinched by the workpiece, the edge of the wheel that is entering into the pinch point can dig into the surface of the material causing the wheel to climb out or kick out. The wheel may either jump toward or away from the operator, depending on direction of the wheel's movement at the point of pinching. Abrasive wheels may also break under these conditions.

Kickback is the result of power tool misuse and/or incorrect operating procedures or conditions and can be avoided by taking proper precautions as given below.

a) Maintain a firm grip on the power tool and position your body and arm to allow you to resist kickback forces. Always use auxiliary handle, if provided, for maximum control over kickback or torque reaction during start-up. The operator can control torque reactions or kickback forces, if proper precautions are taken.

b) Never place your hand near the rotating accessory. Accessory may kickback over your hand.

c) Do not position your body in line with the rotating wheel. Kickback will propel the tool in direction opposite to the wheel's movement at the point of snagging.

d) Use special care when working corners, sharp edges etc. Avoid bouncing and snagging the accessory. Corners, sharp edges or bouncing have a tendency to snag the rotating accessory and cause loss of control or kickback.

e) Do not attach a saw chain, woodcarving blade, segmented diamond wheel with a peripheral gap greater than 10 mm or toothed saw blade. Such blades create frequent kickback and loss of control.

f) Do not "jam" the wheel or apply excessive pressure. Do not attempt to make an excessive depth of cut. Overstressing the wheel increases the loading and susceptibility to twisting or binding of the wheel in the cut and the possibility of kickback or wheel breakage.

g) When wheel is binding or when interrupting a cut for any reason, switch off the power tool and hold the power tool motionless until the wheel comes to a complete stop. Never attempt to remove the wheel from the cut while the wheel is in motion otherwise kickback may occur. Investigate and take corrective action to eliminate the cause of wheel binding.

h) Do not restart the cutting operation in the workpiece. Let the wheel reach full speed and carefully re-enter the cut. The wheel may bind, walk up or kickback if the power tool is restarted in the workpiece.

i) Support panels or any oversized workpiece to minimize the risk of wheel pinching and kickback. Large workpieces tend to sag under their own weight. Supports must be placed under the workpiece near the line of cut and near the edge of the workpiece on both sides of the wheel.

j) Use extra caution when making a "pocket cut" into existing walls or other blind areas. The protruding wheel may cut gas or water pipes, electrical wiring or objects that can cause kickback.

## Additional safety instructions for laser lights

The light/laser radiation used in the Ozito Multi Plunge Cutter PCR-2100 laser is Class 2 with maximum 1mW and 650nm wavelengths. These lasers do not normally present an optical hazard, although staring at the beam may cause flash blindness.



**WARNING!** Do not stare directly at the laser beam. A hazard may exist if you deliberately stare into the beam. Please observe all rules as follows:

• The laser shall be used and maintained in accordance with the manufacturer's instructions.

• Never aim the beam at any person or an object other than the work piece.

• The laser beam shall not be deliberately aimed at personnel and shall be prevented from being directed towards the eye of a person for longer than 0.25s.

• Always ensure the laser beam is aimed at a sturdy work piece without reflective surface<sup>1</sup>, i.e. wood or rough coated surfaces are acceptable. Bright shiny reflective sheet steel or the like is not suitable for laser use as the reflective surface could direct the beam back at the operator.

• Do not change the laser light assembly with a different type. Repairs must only be carried out by a power tool repairer.



**Caution:** Use of controls or adjustments or performance of procedures other than those specified herein may result in hazardous radiation exposure. Please refer to the relevant Australian standards, IEC 60825-1:2011 and IEC 60825-14:2011 for more information on Lasers.





# ELECTRICAL SAFETY



**WARNING!** When using mains-powered tools, basic safety precautions, including the following, should always be followed to reduce risk of fire, electric shock, personal injury and material damage.

Read the whole manual carefully and make sure you know how to switch the tool off in an emergency, before operating the tool.

Save these instructions and other documents supplied with this tool for future reference.

The electric motor has been designed for 230V and 240V only. Always check that the power supply corresponds to the voltage on the rating plate.

Note: The supply of 230V and 240V on Ozito tools are interchangeable for Australia and New Zealand.



This tool is double insulated in accordance with AS/NZS 60745-1; therefore no earth wire is required.

If the supply cord is damaged, it must be replaced by an electrician or a power tool repairer in order to avoid a hazard.

**Note:** Double insulation does not take the place of normal safety precautions when operating this tool. The insulation system is for added protection against injury resulting from a possible electrical insulation failure within the tool.

#### Using an Extension Lead

Always use an approved extension lead suitable for the power input of this tool. Before use, inspect the extension lead for signs of damage, wear and ageing. Replace the extension lead if damaged or defective.

When using an extension lead on a reel, always unwind the lead completely. Use of an extension lead not suitable for the power input of the tool or which is damaged or defective may result in a risk of fire and electric shock.



# GENERAL POWER TOOL SAFETY WARNINGS - PERSONAL SAFETY

**WARNING!** Read all safety warnings and all instructions. Failure to follow the warnings and instructions may result in electric shock, fire and/or serious injury.

Save all warnings and instructions for future reference. The term "power tool" in the warnings refers to your mains-operated (corded) power tool or battery-operated (cordless) power tool.

#### 1. Work area safety

- Keep work area clean and well lit. Cluttered or dark areas invite accidents.
- Do not operate power tools in explosive atmospheres, such as in the presence of flammable liquids, gases or dust. Power tools create sparks which may ignite the dust or fumes.
- Keep children and bystanders away while operating a power tool. Distractions can cause you to lose control.

#### 2. Electrical safety

- Power tool plugs must match the outlet. Never modify the plug in any way. Do not use any adapter plugs with earthed (grounded) power tools. Unmodified plugs and matching outlets will reduce risk of electric shock.
- Avoid body contact with earthed or grounded surfaces, such as pipes, radiators, ranges and refrigerators. There is an increased risk of electric shock if your body is earthed or grounded.
- Do not expose power tools to rain or wet conditions. Water entering a power tool will increase the risk of electric shock.
- Do not abuse the cord. Never use the cord for carrying, pulling or unplugging the power tool. Keep cord away from heat, oil, sharp edges or moving parts. Damaged or entangled cords increase the risk of electric shock.
- When operating a power tool outdoors, use an extension cord suitable for outdoor use. Use of a cord suitable for outdoor use reduces the risk of electric shock.
- If operating a power tool in a damp location is unavoidable, use a residual current device (RCD) protected supply. Use of an RCD reduces the risk of electric shock.

#### 3. Personal safety

- Stay alert, watch what you are doing and use common sense when operating a power tool. Do not use a power tool while you are tired or under the influence of drugs, alcohol or medication. A moment of inattention while operating power tools may result in serious personal injury.
- Use personal protective equipment. Always wear eye protection. Protective equipment such as dust mask, non-skid safety shoes, hard hat, or hearing protection used for appropriate conditions will reduce personal injuries.
- Prevent unintentional starting. Ensure the switch is in the off-position before connecting to power source and/or battery pack, picking up or carrying the tool. Carrying power tools with your finger on the switch or energising power tools that have the switch on invites accidents.

- Remove any adjusting key or wrench before turning the power tool on. A wrench or a key left attached to a rotating part of the power tool may result in personal injury.
  - Do not overreach. Keep proper footing and balance at all times. This enables better control of the power tool in unexpected situations.
  - Dress properly. Do not wear loose clothing or jewellery. Keep your hair, clothing and gloves away from moving parts. Loose clothes, jewellery or long hair can be caught in moving parts.
  - If devices are provided for the connection of dust extraction and collection facilities, ensure these are connected and properly used. Use of dust collection can reduce dust-related hazards.
- #### 4. Power tool use and care
- Do not force the power tool. Use the correct power tool for your application. The correct power tool will do the job better and safer at the rate for which it was designed.
  - Do not use the power tool if the switch does not turn it on and off. Any power tool that cannot be controlled with the switch is dangerous and must be repaired.
  - Disconnect the plug from the power source and/or the battery pack from the power tool before making any adjustments, changing accessories, or storing power tools. Such preventive safety measures reduce the risk of starting the power tool accidentally.
  - Store idle power tools out of the reach of children and do not allow persons unfamiliar with the power tool or these instructions to operate the power tool. Power tools are dangerous in the hands of untrained users.
  - Maintain power tools. Check for misalignment or binding of moving parts, breakage of parts and any other condition that may affect the power tool's operation. If damaged, have the power tool repaired before use. Many accidents are caused by poorly maintained power tools.
  - Keep cutting tools sharp and clean. Properly maintained cutting tools with sharp cutting edges are less likely to bind and are easier to control.
  - Use the power tool, accessories and tool bits etc. in accordance with these instructions, taking into account the working conditions and the work to be performed. Use of the power tool for operations different from those intended could result in a hazardous situation.
- #### 5. Service
- Have your power tool serviced by a qualified repair person using only identical replacement parts. This will ensure that the safety of the power tool is maintained.

# WARRANTY

IN ORDER TO MAKE A CLAIM UNDER THIS WARRANTY YOU MUST RETURN THE PRODUCT TO YOUR NEAREST BUNNINGS WAREHOUSE WITH YOUR BUNNINGS REGISTER RECEIPT. PRIOR TO RETURNING YOUR PRODUCT FOR WARRANTY PLEASE TELEPHONE OUR CUSTOMER SERVICE HELPLINE:

**Australia 1800 069 486**

**New Zealand 0508 069 486**

TO ENSURE A SPEEDY RESPONSE PLEASE HAVE THE MODEL NUMBER AND DATE OF PURCHASE AVAILABLE. A CUSTOMER SERVICE REPRESENTATIVE WILL TAKE YOUR CALL AND ANSWER ANY QUESTIONS YOU MAY HAVE RELATING TO THE WARRANTY POLICY OR PROCEDURE.

The benefits provided under this warranty are in addition to other rights and remedies which are available to you at law.

Our goods come with guarantees that cannot be excluded at law. You are entitled to a replacement or refund for a major failure and for compensation for any other reasonably foreseeable loss or damage. You are also entitled to have the goods repaired or replaced if the goods fail to be of acceptable quality and the failure does not amount to a major failure.

Generally you will be responsible for all costs associated with a claim under this warranty, however, where you have suffered any additional direct loss as a result of a defective product you may be able to claim such expenses by contacting our customer service helpline above.

## 3 YEAR REPLACEMENT WARRANTY

Your product is guaranteed for a period of **36 months from the original date of purchase** and is intended for DIY (Do It Yourself) use only. If a product is defective it will be replaced in accordance with the terms of this warranty. Warranty excludes consumable parts, for example: blades, carbon brushes, hex key etc.

## WARNING

**The following actions will result in the warranty being void.**

- If the tool has been operated on a supply voltage other than that specified on the tool.
- If the tool shows signs of damage or defects caused by or resulting from abuse, accidents or alterations.
- Failure to perform maintenance as set out within the instruction manual.
- If the tool is disassembled or tampered with in any way.
- Professional, industrial or high frequency use.