

**Einhell**<sup>®</sup>

**NEU  
NEW**

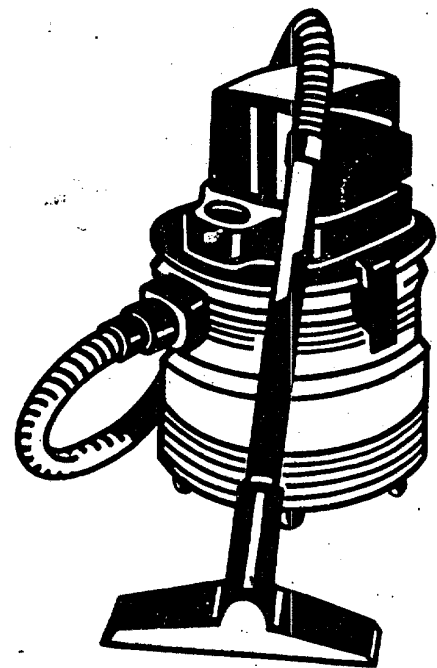

EN 55014  
EN 60555

**EMK 1000**

- Ⓓ Bedienungsanleitung  
Airmaster
- ⒼⒷ Operating Instructions  
Airmaster
- Ⓕ Mode d'emploi  
Airmaster
- ⒶⒾ Gebruiksaanwijzing  
Airmaster
- Ⓔ Instrucciones de servicio  
Airmaster
- ⒫ Instruções para  
Airmaster
- Ⓒ Bruksanvisning  
Airmaster
- ⒶⒻ Käyttöohje  
Airmaster
- ⒶⒾ Bruksanvisning  
Airmaster
- ⒶⒼ Οδηγίες χρήσης  
Airmaster
- Ⓘ Istruzioni per l'uso  
Airmaster
- ⒹⒶ Betjeningsvejledning  
Airmaster



Art.-Nr.: 23.509.90

I.Nr.: 91014

### Naßsaugen

Wet vacuuming  
 Aspiration de matières mouillées  
 Nat zuigen  
 Aspirado húmedo  
 Aspirar substâncias húmidas e líquidos

Schaumstofffilter  
 Cellular foam filter  
 Filtre en matière synthétique  
 Schuimstofffilter  
 Filtro de material sintético  
 Filtro de material alveolar  
 Skummaterialfilter  
 Vaahtomuovifilteri  
 Skumstofffilter  
 Φίλτρο από αφρώδες πλαστικό  
 Filtro di materiale sintetico  
 Skumplastfilter

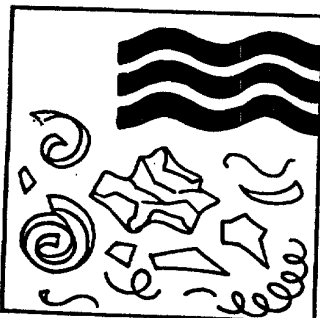
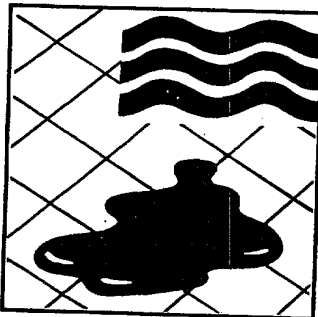
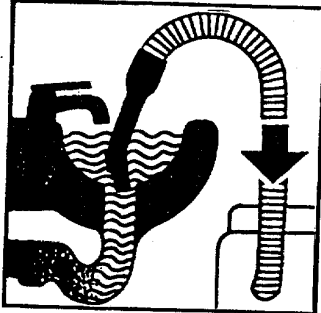
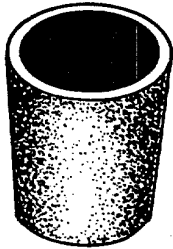

### Våtsugning

Märkäimurointi  
 Våtsugning  
 Απορρόφηση υγρών  
 Aspirazione a umido  
 Vådsugning



14

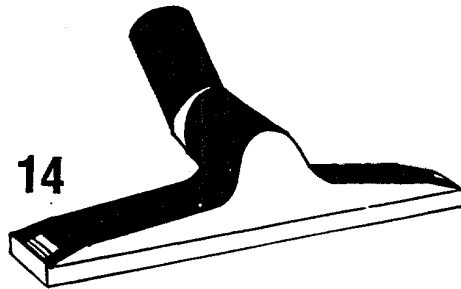

### Trockensaugen

Dry vacuuming  
 Aspiration de matières sèches  
 Droog zuigen  
 Aspirado seco  
 Aspirar substâncias secas

### Torrsugning

Kuivaimurointi  
 Torrsugning  
 Απορρόφηση στερεών  
 Aspirazione a secco  
 Tørugning

Textil- und Papierfilter  
 Textile and paper filter  
 Filtre en papier et en matière textile  
 Textiel- en papierfilter  
 Filtro de papel y material textil  
 Filtro de material têxtil e filtro de papel  
 Textil- och pappersfilter  
 Kangas ja paperifilteri  
 Tekstil- og papirfilter  
 Υφασμάτινο και χάρτινο φίλτρο  
 Filtro di carta e materiale tessile  
 Tekstil- og papirfilter

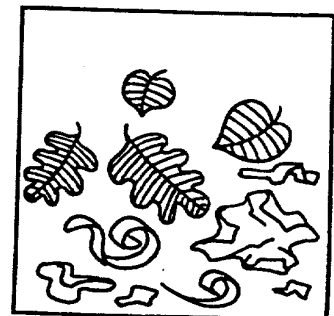
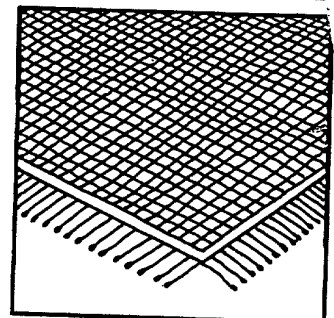
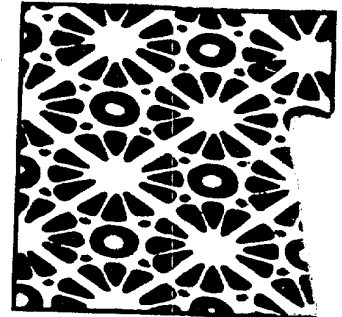
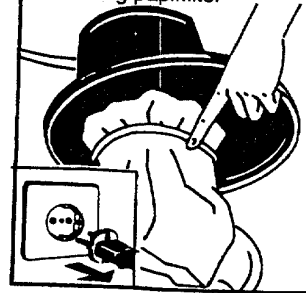

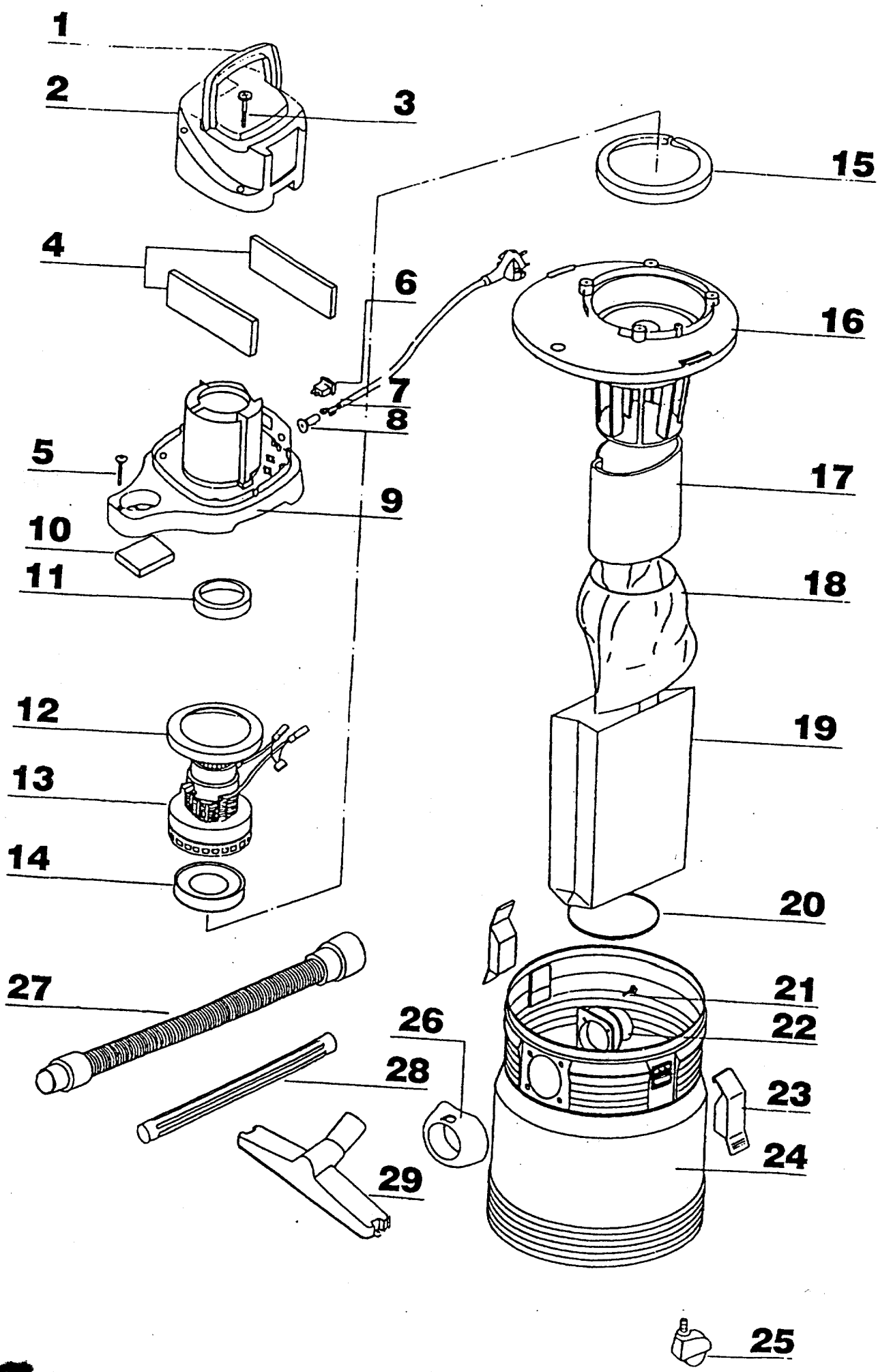

# EMK 1000 - Art.-Nr. 23.509.90 - Ident-Nr. 91014

Pos	Bezeichnung	ET-Nr.
1	Griff	
2	Griffgehäuse	23.509.90.01
3	Schraube 4,35 x 60	23.509.90.02
4	Schalldämmstoff 15 x 60 x 160	23.509.90.03
5	Schraube 3,5 x 25	23.509.90.04
6	Netzschalter	23.509.50.30
7	Netzleitung	23.509.50.12
8	Knickschutztülle	23.509.50.15
9	Aufnahmeteil	23.509.50.16
10	Schalldämmstoff 15 x 73 x 80	23.509.90.05
11	Dichtring	23.509.90.06
12	Gummidichtung	23.509.90.07
13	Motor	23.509.50.20
14	Gummiaufsatz	23.509.80.01
15	Schalldämmstoff 15 x 30 x 500	23.509.90.08
16	Deckel	23.509.90.09
17	Schaumstofffilter	23.509.90.10
18	Stofffilter	23.509.50.31
19	Papierfilter (10 St.)	23.511.40
20	Gummiring	23.511.00
21	Schraube 3,5 x 25	23.509.50.34
22	Saugstutzen innen	23.509.50.30
23	Hakenverschluß	23.509.50.37
24	Behälter Kunststoff	23.509.90.11
25	Lauftrad	23.509.90.12
26	Saugstutzen außen	23.509.50.44
27	Saugklauch	23.509.50.41
28	Saugrohr	23.509.50.51
29	Große Saugdüse	23.509.50.52
		23.509.90.13