



18V BRUSHLESS

125MM ANGLE GRINDER

INSTRUCTION MANUAL

SPECIFICATIONS

Input:	18V
No Load Speed:	8,500/min
Disc Diameter:	125mm (5")
Spindle:	M14
Weight:	1.74kg

ozito.com.au

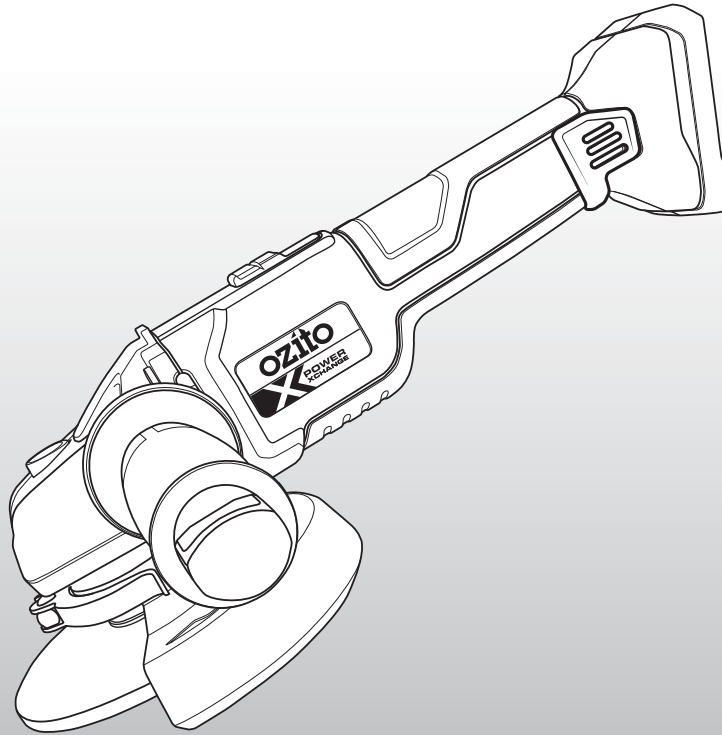

STANDARD EQUIPMENT



Angle Grinder

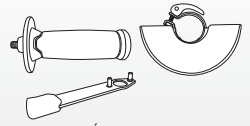

Side Handle, Grinding Guard & Pin Wrench



Grinding Disc

5 YEAR
REPLACEMENT WARRANTY

PXBAGS-125

WARRANTY

IN ORDER TO MAKE A CLAIM UNDER THIS WARRANTY YOU MUST RETURN THE PRODUCT TO YOUR NEAREST BUNNINGS WAREHOUSE WITH YOUR BUNNINGS REGISTER RECEIPT. PRIOR TO RETURNING YOUR PRODUCT FOR WARRANTY PLEASE TELEPHONE OUR CUSTOMER SERVICE HELPLINE:

Australia 1800 069 486
New Zealand 0508 069 486

TO ENSURE A SPEEDY RESPONSE PLEASE HAVE THE MODEL NUMBER AND DATE OF PURCHASE AVAILABLE. A CUSTOMER SERVICE REPRESENTATIVE WILL TAKE YOUR CALL AND ANSWER ANY QUESTIONS YOU MAY HAVE RELATING TO THE WARRANTY POLICY OR PROCEDURE.

WARNING

The following actions will result in the warranty being void.

- If the tool has been operated on a supply voltage other than that specified on the tool.
- If the tool shows signs of damage or defects caused by or resulting from abuse, accidents or alterations.
- Failure to perform maintenance as set out within the instruction manual.
- If the tool is disassembled or tampered with in any way.

The benefits provided under this warranty are in addition to other rights and remedies which are available to you at law.

Our goods come with guarantees that cannot be excluded at law. You are entitled to a replacement or refund for a major failure and for compensation for any other reasonably foreseeable loss or damage. You are also entitled to have the goods repaired or replaced if the goods fail to be of acceptable quality and the failure does not amount to a major failure.

Generally you will be responsible for all costs associated with a claim under this warranty, however, where you have suffered any additional direct loss as a result of a defective product you may be able to claim such expenses by contacting our customer service helpline above.

5 YEAR REPLACEMENT WARRANTY

Your Product is guaranteed for a period of 60 months from the original date of purchase and is intended for DIY (Do It Yourself) use only. If a product is defective it will be replaced in accordance with the terms of this warranty. **Lithium Ion batteries and chargers are covered by a 36 month warranty** and are excluded from the warranty extension. Warranty excludes consumable parts.

KNOW YOUR PRODUCT

BRUSHLESS 125MM ANGLE GRINDER

- | | |
|----------------------------------|------------------------|
| 1. Spindle Lock | 6. Sure Grip Handle |
| 2. Side Handle | 7. Grinding Guard |
| 3. Lock On Slide Switch | 8. Pin Wrench |
| 4. Dust Guard / Ventilation Mesh | 9. Guard Locking Lever |
| 5. Battery Seating | 10. Grinding Disc |

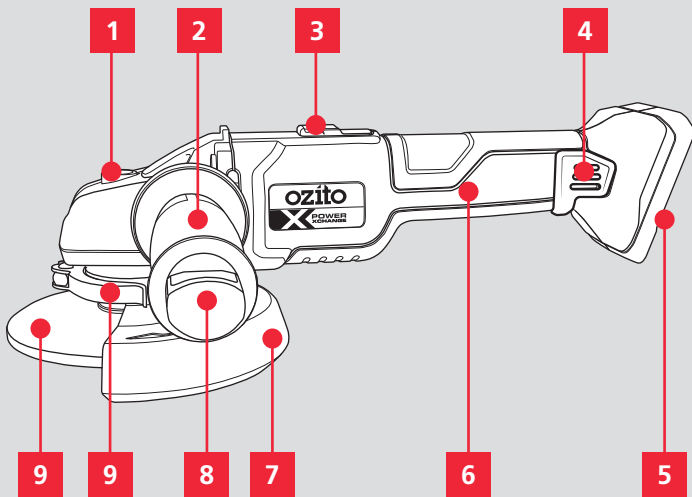

BATTERY & CHARGER

This tool is compatible with all batteries & chargers from the Ozito PXC range.

For optimal performance, we recommend the use of a 3.0Ah battery or higher to operate this PXC tool.

ONLINE MANUAL

Scan this QR Code with your mobile device to take you to the online manual.



SETUP & PREPARATION

1. ASSEMBLY



WARNING! ENSURE THE TOOL IS SWITCHED OFF AND THE BATTERY IS REMOVED BEFORE PERFORMING ANY OF THE FOLLOWING TASKS.

Fitting The Side Handle

1. To fit, screw the side handle clockwise into 1 of 2 handle positions.

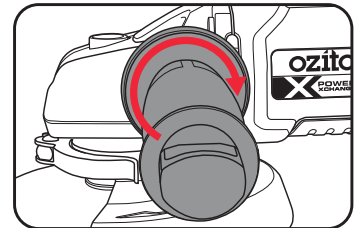

2. To remove, screw the handle anti-clockwise.

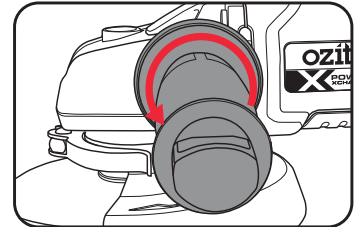

Fitting The Safety Guard

1. Loosen the safety guard locking lever to allow it to spin.

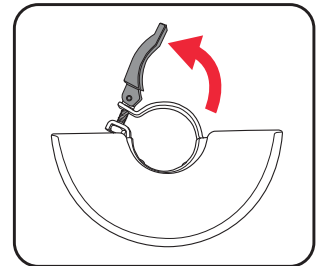

2. Align the notches, rotate the guard into the desired position and secure in place with the locking lever.

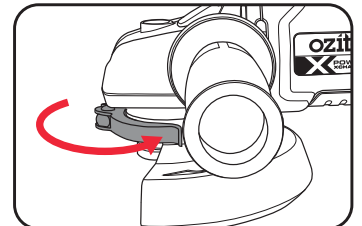

WARNING! DO NOT OPERATE THE ANGLE GRINDER WITHOUT THE SAFETY GUARD FITTED AS POSSIBLE INJURIES COULD OCCUR.

5 YEAR
REPLACEMENT WARRANTY

2. FITTING THE DISC

WARNING! ENSURE THE TOOL IS SWITCHED OFF AND THE BATTERY IS REMOVED BEFORE PERFORMING ANY OF THE FOLLOWING TASKS.

WARNING! ALWAYS WEAR GLOVES WHEN CHANGING THE DISC OR GUARD. THE DISC, GUARD AND WORKPIECE WILL BECOME HOT DURING USE.

1. Pull the pin wrench out from the side handle.

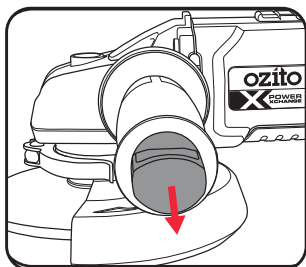

2. Depress and hold the spindle lock to prevent the spindle rotating.

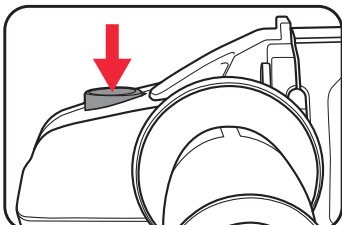

3. Align the pins of the pin wrench to the flange holes and loosen by rotating it anti-clockwise.

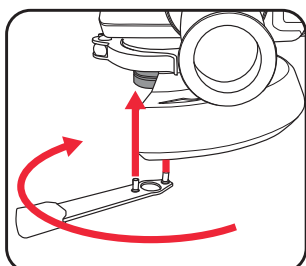

4. Remove the flange and replace the grinding disc on the spindle.

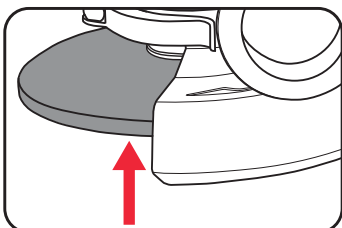

5. When assembling the outer flange, ensure you select the correct orientation to suit the type of disc being fitted.

Grinding disc: Place outer flange with the raised lip upwards.

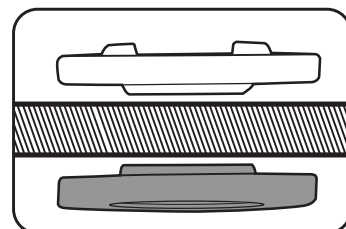

Cutting disc: Place outer flange with the raised lip downwards.

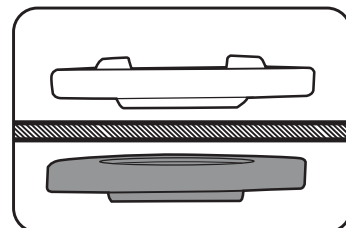

WARNING! WHEN USING THE ANGLE GRINDER WITH A CUTTING DISC, A CUTTING GUARD (NOT SUPPLIED) MUST BE FITTED PRIOR TO OPERATION. FAILURE TO DO SO MAY RESULT IN SERIOUS INJURY.

6. Screw the flange back onto the spindle and tighten using the pin wrench while holding the spindle lock down.

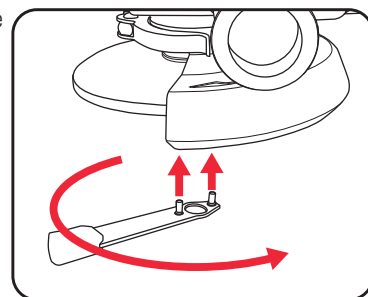

3. CHANGING THE GUARD

WARNING! ENSURE THE TOOL IS SWITCHED OFF AND THE BATTERY IS REMOVED BEFORE PERFORMING ANY OF THE FOLLOWING TASKS.

A safety guard should be used at all times whilst operating the angle grinder, but there are times when you should swap the guard, such as when switching from a grinding disc to a cutting disc.

1. To remove a guard, you must first remove the disc if one is installed.

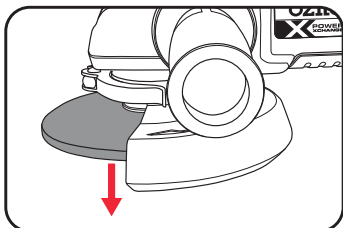

2. Loosen the safety guard locking lever to allow it to spin.

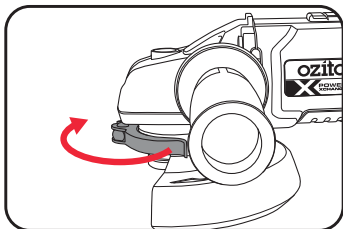

3. Remove the guard by aligning the notches and pulling away from the tool.

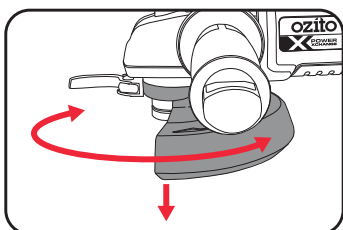

4. Choose the correct guard for the job. Semi open guards are designed for grinding whilst the fully enclosed guards are designed for cutting disks.

Use ONLY the semi-open grinding guard with a grind disc

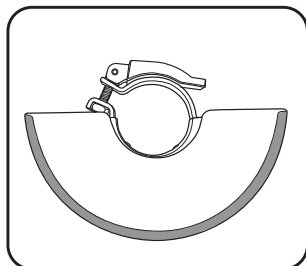

Use ONLY the fully enclosed cutting guard with a cutting disc

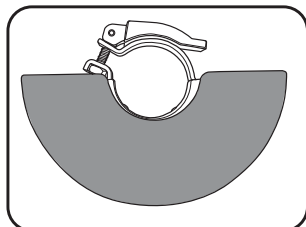

5. Fit the correct guard to match the correct disc, rotate to the desired position and secure in place with the locking lever.

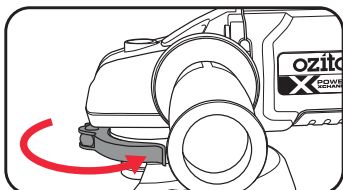

4. FITTING THE BATTERY

Installing The Battery Pack

1. Slide the battery into the tool base until it clicks into place.

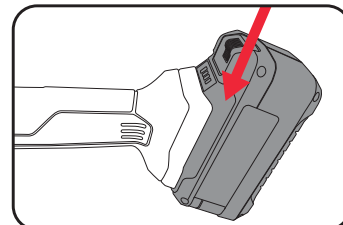

Removing The Battery Pack

1. Hold down the battery release button and then slide the battery out.

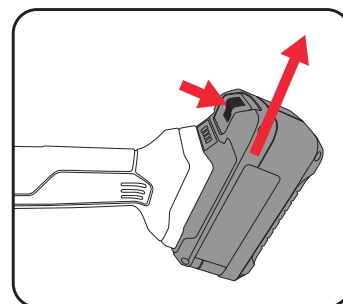

OPERATION

5. CONTROLS

Switching The Tool On & Off

1. To turn on, hold the angle grinder firmly with both handles, press down on the back end of the switch and slide it forward.

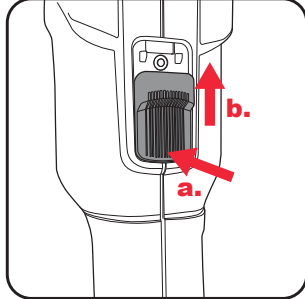

2. To use the lock on function, press down on the back end of the switch, slide it fully forward and then press down on the front end of the switch to lock it in position.

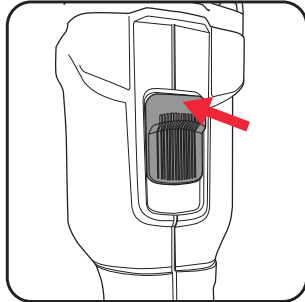

3. To turn off, Push the rear of the switch and the switch will automatically spring backwards into the off position.

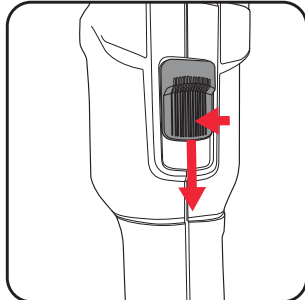

6. GRINDING



WARNING! ALWAYS HOLD THE SIDE HANDLE AND SURE GRIP HANDLE WITH BOTH HANDS FOR ALL GRINDING AND CUTTING APPLICATIONS.

1. Ensure the workpiece is securely held down.

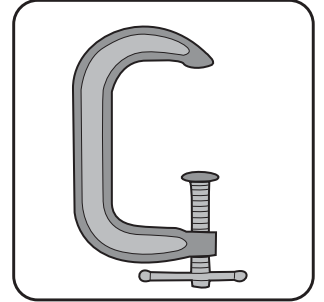

2. Hold the angle grinder firmly with both handles and switch on.

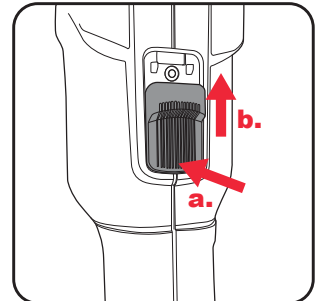

3. Begin grinding your workpiece. The optimum grinding angle is 10-15° to the workpiece.

Note: Do not apply excessive pressure. Allow the tool to do the work, this will prevent deep gouging.

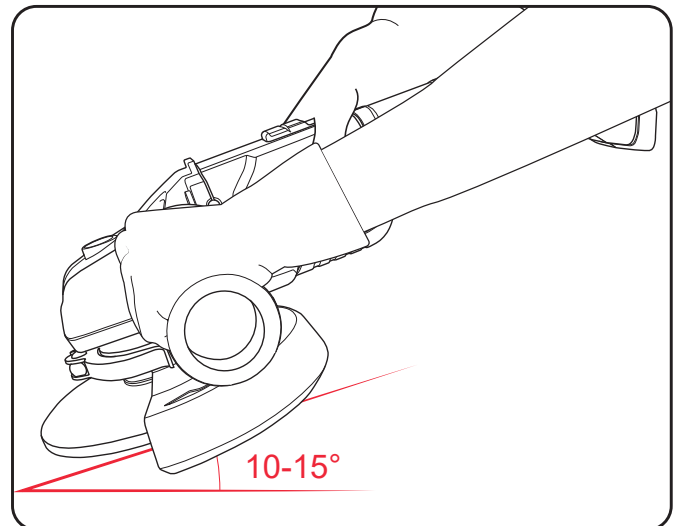

6. CUTTING



WARNING! WHEN USING THE ANGLE GRINDER WITH A CUTTING DISC, A CUTTING GUARD (NOT SUPPLIED) MUST BE FITTED PRIOR TO OPERATION. FAILURE TO DO SO MAY RESULT IN SERIOUS INJURY.

1. Ensure the workpiece is securely held down.

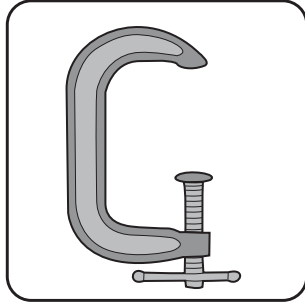

2. Hold the angle grinder firmly with both handles and switch on.

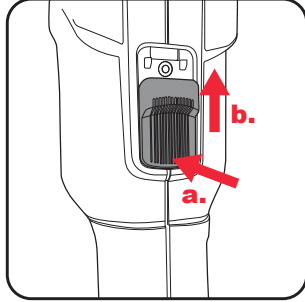

3. The optimum angle is 90° to the workpiece. Do not apply excessive pressure. Allow the tool to do the work.

Note: Do not apply excessive pressure. Allow the tool to do the work

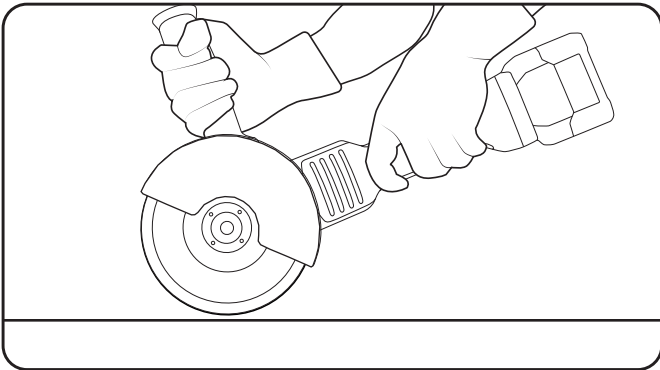

WARNING! AFTER EVERY USE, CLEAN THE VENTILATION MESH ON THE HOUSING TO PREVENT OVERHEATING THE MOTOR. THE VENTILATION MESH MUST BE USED IN ALL APPLICATIONS.



WARNING! AFTER ALL DUSTY APPLICATIONS, USE COMPRESSED AIR TO CLEAN THE SWITCH OF ANY DUST.

7. TROUBLESHOOTING

LED lights do not illuminate on charger

Check the charging adaptor is securely plugged into the wall outlet.
Check the battery is firmly connected to the charging cradle.
Check that the charging jack is securely connected to the charging cradle.

The battery has a short run time

Ensure the battery is properly charged. It will take 4-5 charging cycles before the battery reaches optimum charge and run time. On the initial charge, the battery requires 5 hours of charging. Subsequent charging only requires 3-5 hours.

Spindle locking button will not depress

The spindle will need to be rotated until the lock can engage. Simply rotate the spindle while applying a small amount of pressure on the spindle lock.

Angle grinder does not turn on after a period of inactivity

The tool switches to 'Standby Mode' after 10 minutes of inactivity. To switch back on, slide the power switch forward twice or press the battery indicator.

Standby mode protects the battery whilst not in use.

MAINTENANCE



WARNING! BEFORE CLEANING OR CARRYING OUT ANY MAINTENANCE PROCEDURE, ENSURE THAT THE BATTERIES HAVE BEEN REMOVED.

Cleaning

- Keep the ventilation slots of the tool clean at all times to ensure efficient operation.
- After each use, blow air through the tool housing to ensure it is free from all dust, dirt, etc. Build up of dust or dirt particles may cause the tool to overheat and shorten the life of the tool.
- If the housing of the tool requires cleaning, do not use solvents. Use of a cloth only is recommended.
- Never allow any liquid to get inside the tool, never immerse any part of the tool into liquid.

Cleaning The Dust Guard & Ventilation Mesh

1. Gently flex one side of the dust guard away from the handle.

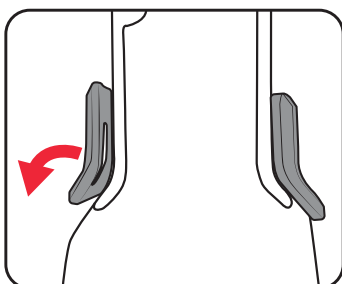

2. Unhook the dust guard from the tool.

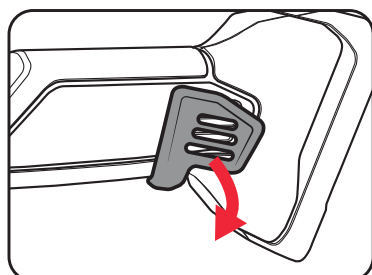

3. Use compressed air to clean the ventilation mesh on the tool and dust guard. If necessary, use a soft, dry cloth to wipe the dust guard clean.
4. Press the pins on the inside of the dust guard against the tool handle and then re-attach the dust guard.

Storage

When not in use, the tool should be stored in a dry, frost free location, keep out of children's reach.

Note: Ozito Industries will not be responsible for any damage or injuries caused by repair of the tool by an unauthorised person or by mishandling.

DESCRIPTION OF SYMBOLS

V	Volts	mm	Millimetres
	Direct Current	η_0	No load speed
/min	Revolutions per minute		Wear eye, ear & breathing protection
	Wear gloves		Wear hearing protection
	Wear breathing protection		Wear eye protection
	Double insulated		Warning
	Read Instruction Manual		Regulatory Compliance Mark (RCM)

CARING FOR THE ENVIRONMENT



Power tools that are no longer usable should not be disposed of with household waste but in an environmentally friendly way. Please recycle where facilities exist. Check with your local council authority for recycling advice.



Recycling packaging reduces the need for landfill and raw materials. Reuse of recycled material decreases pollution in the environment. Please recycle packaging where facilities exist. Check with your local council authority for recycling advice.

SPARE PARTS

Spare parts can be ordered from the Special Orders Desk at your local Bunnings Warehouse.

For further information, or any parts not listed here, visit www.ozito.com.au or contact Ozito Customer Service:

Australia 1800 069 486

New Zealand 0508 069 486

E-mail: enquiries@ozito.com.au

ELECTRICAL SAFETY



WARNING! When using mains-powered tools, basic safety precautions, including the following, should always be followed to reduce risk of fire, electric shock, personal injury and material damage. Read the whole manual carefully and make sure you know how to switch the tool off in an emergency, before operating the tool. Save these instructions and other documents supplied with this tool for future reference.

The charger has been designed for 230V and 240V only. Always check that the power supply corresponds to the voltage on the rating plate.

Note: The supply of 230V and 240V on Ozito tools are interchangeable for Australia and New Zealand.

This tool's charger is double insulated; therefore no earth wire is required.

Note: Double insulation does not take the place of normal safety precautions when operating this tool. The insulation system is for added protection against injury resulting from a possible electrical insulation failure within the tool.
If the supply cord is damaged, it must be replaced by an electrician or a power tool repairer in order to avoid a hazard.

The power supply for this product's charger should be protected by a residual current device (rated at 30mA or less). A residual current device reduces the risk of electric shock.

GENERAL POWER TOOL SAFETY WARNINGS



WARNING! Read all safety warnings and all instructions. Failure to follow the warnings and instructions may result in electric shock, fire and/or serious injury.

Save all warnings and instructions for future reference. The term "power tool" in the warnings refers to your mains-operated (corded) power tool or battery-operated (cordless) power tool.

1. Work area safety

- Keep work area clean and well lit. Cluttered or dark areas invite accidents.
- Do not operate power tools in explosive atmospheres, such as in the presence of flammable liquids, gases or dust. Power tools create sparks which may ignite the dust or fumes.
- Keep children and bystanders away while operating a power tool. Distractions can cause you to lose control.

2. Electrical safety

- Power tool plugs must match the outlet. Never modify the plug in any way. Do not use any adapter plugs with earthed (grounded) power tools. Unmodified plugs and matching outlets will reduce risk of electric shock.
- Avoid body contact with earthed or grounded surfaces, such as pipes, radiators, ranges and refrigerators. There is an increased risk of electric shock if your body is earthed or grounded.
- Do not expose power tools to rain or wet conditions. Water entering a power tool will increase the risk of electric shock.
- Do not abuse the cord. Never use the cord for carrying, pulling or unplugging the power tool. Keep cord away from heat, oil, sharp edges or moving parts. Damaged or entangled cords increase the risk of electric shock.
- When operating a power tool outdoors, use an extension cord suitable for outdoor use. Use of a cord suitable for outdoor use reduces the risk of electric shock.
- If operating a power tool in a damp location is unavoidable, use a residual current device (RCD) protected supply. Use of an RCD reduces the risk of electric shock.

3. Personal safety

- Stay alert, watch what you are doing and use common sense when operating a power tool. Do not use a power tool while you are tired or under the influence of drugs, alcohol or medication. A moment of inattention while operating power tools may result in serious personal injury.
- Use personal protective equipment. Always wear eye protection. Protective equipment such as dust mask, non-skid safety shoes, hard hat, or hearing protection used for appropriate conditions will reduce personal injuries.
- Prevent unintentional starting. Ensure the switch is in the off-position before connecting to power source and/or battery pack, picking up or carrying the tool. Carrying power tools with your finger on the switch or energising power tools that have the switch on invites accidents.
- Remove any adjusting key or wrench before turning the power tool on. A wrench or a key left attached to a rotating part of the power tool may result in personal injury.
- Do not overreach. Keep proper footing and balance at all times. This enables better control of the power tool in unexpected situations.
- Dress properly. Do not wear loose clothing or jewellery. Keep your hair, clothing and gloves away from moving parts. Loose clothes, jewellery or long hair can be caught in moving parts.
- If devices are provided for the connection of dust extraction and collection facilities, ensure these are connected and properly used. Use of dust collection can reduce dust-related hazards.
- Do not let familiarity gained from frequent use of tools allow you to become complacent and ignore

tool safety principles. A careless action can cause severe injury within a fraction of a second.

4. Power tool use and care

- Do not force the power tool. Use the correct power tool for your application. The correct power tool will do the job better and safer at the rate for which it was designed.
- Do not use the power tool if the switch does not turn it on and off. Any power tool that cannot be controlled with the switch is dangerous and must be repaired.
- Disconnect the plug from the power source and/or the battery pack from the power tool before making any adjustments, changing accessories, or storing power tools. Such preventive safety measures reduce the risk of starting the power tool accidentally.
- Store idle power tools out of the reach of children and do not allow persons unfamiliar with the power tool or these instructions to operate the power tool. Power tools are dangerous in the hands of untrained users.
- Maintain power tools. Check for misalignment or binding of moving parts, breakage of parts and any other condition that may affect the power tool's operation. If damaged, have the power tool repaired before use. Many accidents are caused by poorly maintained power tools.
- Keep cutting tools sharp and clean. Properly maintained cutting tools with sharp cutting edges are less likely to bind and are easier to control.
- Use the power tool, accessories and tool bits etc. in accordance with these instructions, taking into account the working conditions and the work to be performed. Use of the power tool for operations different from those intended could result in a hazardous situation.
- Keep handles and grasping surfaces dry, clean and free from oil and grease. Slippery handles and grasping surfaces do not allow for safe handling and control of the tool in unexpected situations.

5. Battery tool use and care

- Recharge only with the charger specified by the manufacturer. A charger that is suitable for one type of battery pack may create a risk of fire when used with another battery pack.
- Use power tools only with specifically designated battery packs. Use of any other battery packs may create a risk of injury and fire.
- When battery pack is not in use, keep it away from other metal objects, like paper clips, coins, keys, nails, screws or other small metal objects, that can make a connection from one terminal to another. Shorting the battery terminals together may cause burns or a fire.
- Under abusive conditions, liquid may be ejected from the battery; avoid contact. If contact accidentally occurs, flush with water. If liquid contacts eyes, additionally seek medical help. Liquid ejected from the battery may cause irritation or burns.
- Do not use a battery pack or tool that is damaged or modified. Damaged or modified batteries may exhibit unpredictable behaviour resulting in fire, explosion or risk of injury.
- Do not expose a battery pack or tool to fire or excessive temperature. Exposure to fire or temperature above 130°C may cause explosion.
- Follow all charging instructions and do not charge the battery pack or tool outside the temperature range specified in the instructions. Charging improperly or at temperatures outside the specified range may damage the battery and increase the risk of fire.

6. Service

- Have your power tool serviced by a qualified repair person using only identical replacement parts. This will ensure that the safety of the power tool is maintained.
- Never service damaged battery packs. Service of battery packs should only be performed by the manufacturer or authorized service provider.

ANGLE GRINDER SAFETY WARNINGS



WARNING! This appliance is not intended for use by persons (including children) with reduced physical, sensory or mental capabilities, or lack of experience and knowledge, unless they have been given supervision or instruction concerning use of the appliance by a person responsible for their safety.

- This power tool is intended to function as a grinder, sanding or cut-off tool. Read all safety warnings, instructions, illustrations and specifications provided with this power tool. Failure to follow all instructions listed below may result in electric shock, fire and/or serious injury.
- Operations such as wire brushing, or polishing are not recommended to be performed with this power tool. Operations for which the power tool was not designed may create a hazard and cause personal injury.
- Do not use accessories which are not specifically designed and recommended by the tool manufacturer. Just because the accessory can be attached to your power tool, it does not assure safe operation.
- The rated speed of the accessory must be at least equal to the maximum speed marked on the power tool. Accessories running faster than their rated speed can break and fly apart.
- The outside diameter and the thickness of your accessory must be within the capacity rating of your power tool. Incorrectly sized accessories cannot be adequately guarded or controlled.
- The arbour size of wheels, flanges, backing pads or any other accessory must properly fit the spindle of the power tool. Accessories with arbour holes that do not match the mounting hardware of the power tool will run out of balance, vibrate excessively and may cause loss of control.
- Do not use a damaged accessory. Before each use inspect the accessory such as abrasive wheels for chips and cracks, backing pad for cracks, tear or excess wear, wire brush for loose or cracked wires. If power tool or accessory is dropped, inspect for damage or install an undamaged accessory. After inspecting and installing an accessory, position yourself and bystanders away from the plane of the rotating accessory and run the power tool at maximum no-load speed for one minute. Damaged accessories will normally break apart during this test time.
- Wear personal protective equipment. Depending on application, use face shield, safety goggles or safety glasses. As appropriate, wear dust mask, hearing protectors, gloves and workshop apron capable of stopping small abrasive or work piece fragments. The eye protection must be capable of stopping flying debris generated by various operations. The dust mask or respirator must be capable of filtering particles generated by your operation. Prolonged exposure to high intensity noise may cause hearing loss.
- Keep bystanders a safe distance away from work area. Anyone entering the work area must wear personal protective equipment. Fragments away and cause injury beyond immediate area of operation.
- Hold power tool by insulated gripping surfaces only, when performing an operation where the cutting accessory may contact hidden wiring or its own cord. Cutting accessory contacting a "live" wire may make exposed metal parts of the power tool "live" and shock the operator.
- Never lay the power tool down until the accessory has come to a complete stop. The spinning accessory may grab the surface and pull the power tool out of your control.
- Do not run the power tool while carrying it at your side. Accidental contact with the spinning accessory could snag your clothing, pulling the accessory into your body.
- Regularly clean the power tool's air vents. The motor's fan will draw the dust inside the housing and excessive accumulation of powdered metal may cause electrical hazards.
- Do not operate the power tool near flammable materials. Sparks could ignite these materials.
- Do not use accessories that require liquid coolants. Using water or other liquid coolants may result in electrocution or shock.
- Kickback is a sudden reaction to a pinched or snagged rotating wheel, backing pad, brush or any other accessory. Pinching or snagging causes rapid stalling of the rotating accessory which in turn causes the uncontrolled power tool to be forced in the direction opposite of the accessory's rotation at the point of the binding. For example, if an abrasive wheel is snagged or pinched by the work piece, the edge of the wheel that is entering into the pinch point can dig into the surface of the material causing the wheel to climb out or kick out. The wheel may either jump toward or away from the operator, depending on direction of the wheel's movement at the point

of pinching. Abrasive wheels may also break under these conditions. Kickback is the result of power tool misuse and/or incorrect operating procedures or conditions and can be avoided by taking proper precautions as given below.

- Maintain a firm grip on the power tool and position your body and arm to allow you to resist kickback forces. Always use auxiliary handle, if provided, for maximum control over kickback or torque reaction during start-up. The operator can control torque reactions or kickback forces, if proper precautions are taken.
- Never place your hand near the rotating accessory. Accessory may kickback over your hand.
- Do not position your body in the area where power tool will move if kickback occurs. Kickback will propel the tool in direction opposite to the wheel's movement at the point of snagging.
- Use special care when working corners, sharp edges etc. Avoid bouncing and snagging the accessory. Corners, sharp edges or bouncing have a tendency to snag the rotating accessory and cause loss of control or kickback.
- Do not attach a saw chain woodcarving blade or toothed saw blade. Such blades create frequent kickback and loss of control.
- Use only wheel types that are recommended for your power tool and the specific guard designed for the selected wheel. Wheels for which the power tool was not designed cannot be adequately guarded and are unsafe.
- The guard must be securely attached to the power tool and positioned for maximum safety, so the least amount of wheel is exposed towards the operator. The guard helps to protect operator from broken wheel fragments and accidental contact with wheel.
- Wheels must be used only for recommended applications. For example: do not grind with the side of cut-off wheel. Abrasive cut-off wheels are intended for peripheral grinding, side forces applied to these wheels may cause them to shatter.
- Always use undamaged wheel flanges that are of correct size and shape for your selected wheel. Proper wheel flanges support the wheel thus reducing the possibility of wheel breakage. Flanges for cut-off wheels may be different from grinding wheel flanges.
- Do not use worn down wheels from larger power tools. Wheel intended for larger power tool is not suitable for the higher speed of a smaller tool and may burst.
- Additional safety instructions for abrasive cutting-off operations:
 - Do not "jam" the cut-off wheel or apply excessive pressure. Do not attempt to make an excessive depth of cut. Overstressing the wheel increases the loading and susceptibility to twisting or binding of the wheel in the cut and the possibility of kickback or wheel breakage.
 - Do not position your body in line with and behind the rotating wheel. When the wheel, at the point of operation, is moving away from your body, the possible kickback may propel the spinning wheel and the power tool directly at you.
 - When wheel is binding or when interrupting a cut for any reason, switch off the power tool and hold the power tool motionless until the wheel comes to a complete stop. Never attempt to remove the cut-off wheel from the cut while the wheel is in motion otherwise kickback may occur. Investigate and take corrective action to eliminate the cause of wheel binding.
 - Do not restart the cutting operation in the work piece. Let the wheel reach full speed and carefully reenter the cut. The wheel may bind, walk up or kickback if the power tool is restarted in the work piece.
 - Support panels or any oversized work piece to minimize the risk of wheel pinching and kickback. Large work pieces tend to sag under their own weight. Supports must be placed under the work piece near the line of cut and near the edge of the work piece on both sides of the wheel.
 - Use extra caution when making a "pocket cut" into existing walls or other blind areas. The protruding wheel may cut gas or water pipes, electrical wiring or objects that can cause kickback.
 - Do not use excessively oversized sanding disc paper. Follow manufacturer's recommendations, when selecting sanding paper. Larger sanding paper extending beyond the sanding pad presents a laceration hazard and may cause snagging, tearing of the disc or kickback.
- When using abrasive cutting wheels, a cutting guard MUST be fitted to your angle grinder. These cutting guards are available as a spare part and can be ordered through the special orders desk.