

GB

**Manual Instructions
Power Generator**

PRO  [®]
WORK

7

CE

Art.-Nr.: 41.523.80

I.-Nr.: 01018

PPG 2500 G

PREFACE

Thank you for purchasing products from Prowork. We appreciate your business. The following manual is only a guide to assist you and is not a complete or comprehensive manual of all aspects of maintaining and repairing your generator. The equipment you have purchased is a complex piece of machinery. We recommend that that you consult with a dealer if you have doubts or concerns as to your experience or ability to properly maintain or repair your equipment. You will save time and the inconvenience of having to go back to the store if you choose to write or call us concerning missing parts, service questions, operating advice, and/or assembly questions. Our LPG generators have some of the following features:

- . Light weight construction
- . Air cooled
- . Four-stroke LPG internal combustion engine
- . Recoil starter
- . Automatic voltage stabilizer
- . NFB circuit protector
- . AC outputs
- . Low oil level sensor

The ETQ air-cooled **LPG** generators are widely used when electrical power is scarce. Our generators provide a portable mobile solution in supplying power for field operations during project construction.

This manual will explain how to operate and service your generator set.

If you have any questions or suggestions about this manual, please contact your local dealer or us directly. ***Consumers should notice that this manual might differ slightly from the actual product as more improvements are made to our products. Some of the pictures in this manual may differ slightly from the actual product as well.***

TABLE OF

Introduction	Adjustments.....
Portable Power Generator.....	Maintenance Schedule.....
This Booklet.....	Generator Maintenance.....
Manual Conventions	Storage
Safety Rules	Engine Storage.....
Controls and Features.....	Generator Storage.....
Generator.....	Specifications
Power Panel	Engine Specifications.....
Parts Included	Generator Specifications.....
Assembly.....	Fuel.....
Remove the Generator from the Shipping Carton	Oil.....
Install the Wheel Kit.....	Spark Plugs
Install the Support Leg.....	Valve Clearance.....
Install the Handle.....	Parts Diagram.....
Install the Spark Arrester (optional).....	Parts List
Add Engine Oil	Troubleshooting
Add Fuel.....	Contact Information
Grounding.....	
Operation	
Generator Location.....	
Grounding.....	
Surge Protection	
Starting the Engine.....	
Connecting Electrical Loads.....	
Stopping the Engine	
Do Not Overload Generator.....	
Capacity.....	
Power Management.....	
Wattage Reference Chart.....	
Maintenance.....	
Engine Maintenance.....	
Oil.....	
Spark Plugs.....	
Air Filter.....	
Spark Arrester (if installed).....	
Cleaning.....	

Introduction

Congratulations on your purchase of a Prowork Power generator. Prowork Designs and builds generators to strict Specifications. With proper use and Maintenance, this generator will bring years of satisfying service.

Portable Power Generator

This unit is a LPG engine driven, alternating current (AC) generator. It is designed to supply electrical power for lighting, appliances, tools and similar equipments.

This Booklet

Every effort has been made to ensure the accuracy and completeness of the information in this manual. We reserve the right to change, alter and/or improve the product and this document at any time without prior notice.

Manual Conventions

This manual uses the following symbols to help differentiate between different kinds of information. The safety symbol is used with a key word to alert you to potential hazards in operating and owning power equipment. Follow all safety messages to avoid or reduce the risk of serious injury or death.

DANGER

DANGER indicates an imminently hazardous situation which, if not avoided, will result in death or serious injury.

WARNING

WARNING indicates a potentially hazardous situation which, if not avoided, could result in death or serious injury.

CAUTION

CAUTION indicates a potentially hazardous situation which, if not avoided, may result in minor or moderate injury.

CAUTION

CAUTION used without the safety alert symbol indicates a potentially hazardous situation which, if not avoided, may result in property damage.

Safety Rules

WARNING

Read this manual thoroughly before operating your generator. Failure to follow instructions could result in serious injury or death.

WARNING

The engine exhaust from this product contains chemicals known to the state of California to cause cancer, birth defects, or other reproductive harm.

DANGER

Generator exhaust contains carbon monoxide, a odorless, odorless, poison gas. Breathing carbon monoxide will cause nausea, dizziness, fainting or death.

Operate generator outdoors only in a well ventilated area
DO NOT operate the generator inside any building, enclosure or compartment, including the generator compartment of a recreational vehicle.
DO NOT allow exhaust fumes to enter a confined area through windows, doors, vents or

DANGER

Rotating parts can entangle hands, feet, hair, clothing and/or accessories.
Traumatic amputation or severe laceration can

Keep hands and feet away from rotating parts.
Tie up long hair and remove jewelry.
Operate equipment with guards in place.
DO NOT wear loose-fitting clothing, dangling drawstrings or items that could become caught.

DANGER

Generator produces powerful voltage.

DO NOT touch bare wires or receptacles.
DO NOT use electrical cords that are worn, damaged or frayed.
DO NOT operate generator in wet weather.
DO NOT allow children or unqualified persons to operate or service the generator
Use a ground fault circuit interrupter (GFCI) in damp areas and areas containing conductive material such as metal decking.
Use approved transfer equipment to isolate generator from your electric utility and Notify your utility company before connecting your generator to your power system.

WARNING

Sparks can result in fire or electrical shock.

When servicing the generator:

Disconnect the spark plug wire and place it where it cannot contact the plug.
DO NOT check for spark with the plug removed.
Use only approved spark plug testers.

WARNING

Running engines produce heat.
Severe burns can occur on contact.
Combustible material can catch fire on contact.

DO NOT touch hot surfaces.
Avoid contact with hot exhaust gases.
Allow equipment to cool before touching.
Maintain at least three feet of clearance on all sides to ensure adequate cooling.
Maintain at least five feet of clearance from combustible materials.

DANGER

Fuel and fuel vapors are highly flammable and extremely explosive.
Fire or explosion can cause severe burns or death.
Unintentional startup can result in entanglement, traumatic amputation or laceration.

When adding or removing fuel

Turn the generator off and let it cool for at least two minutes before removing the fuel cap.
Loosen the cap slowly to relieve pressure in the tank.
Only fill or drain fuel outdoors in a well-ventilated area.
DO NOT overfill the fuel tank.
Always keep fuel away from sparks, open flames, pilot lights, heat and other sources of ignition.
DO NOT light or smoke cigarettes.

When starting the generator

DO NOT attempt to start a damaged generator.
Make certain that the gas cap, air filter, spark plug, fuel lines and exhaust system are properly in place.
Allow spilled fuel to evaporate fully before attempting to start the engine.
Make certain that the generator is resting firmly on level ground.

When operating the generator:

DO NOT move or tip the generator during operation.
DO NOT tip the generator or allow fuel or oil to spill.

When transporting or servicing the generator:

Make certain that the fuel shutoff valve is in the off position and the fuel tank is empty.
Disconnect the spark plug wire.

When storing the generator:

Store away from sparks, open flames, pilot lights, heat and other sources of ignition.

WARNING

When use the LPG generator, if find any abnormality (LPG leakage or strange smells), please turn off the unit & LPG tank immediately and then check the connection tube to insure to use the unit safely.

WARNING

Rapid retraction of the starter cord will pull hand and arm towards the engine faster than you can let go.
Unintentional startup can result in entanglement, traumatic amputation or laceration.
Broken bones, fractures, bruises or sprains could result.

When starting engine, pull the starter cord slowly until resistance is felt and then pull rapidly to avoid kickback.
DO NOT start or stop the engine with electrical

CAUTION

Exceeding the generator's running capacity can damage the generator and/or electrical devices connected to it

DO NOT overload the generator.
Start the generator and allow the engine to stabilize before connecting electrical loads.
Connect electrical equipment in the off position, and then turn them on for operation.
Turn electrical equipment off and disconnect before stopping the generator.
DO NOT tamper with the governed speed.
DO NOT modify the generator in any way.

CAUTION

Improper treatment or use of the generator can damage it, shorten its life and void your warranty.

Use the generator only for intended uses.
Operate only on level surfaces.
DO NOT expose generator to excessive moisture, dust, or dirt.
DO NOT allow any material to block the cooling slots.
If connected devices overheat, turn them off and disconnect them from the generator.
DO NOT use the generator if:
Electrical output is lost
Equipment sparks, smokes or emits flames
Equipment vibrates excessively

Controls and Features

Controls and Features

Read this owner's manual before operating your generator. Familiarize yourself with the location and function of the controls and features. Save this manual for future reference.

Generator

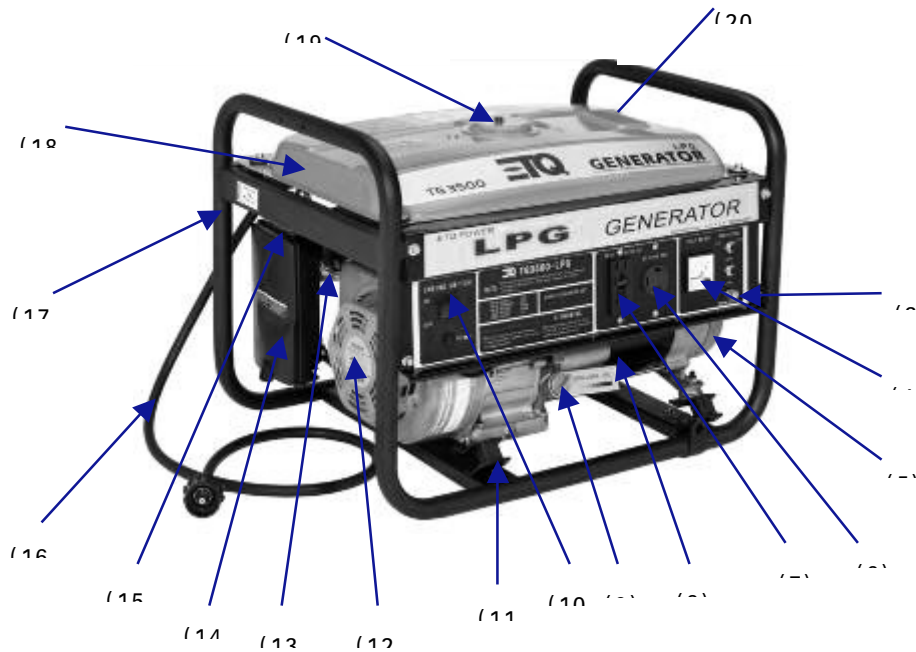

NO.	DESCRIPTION	Qty	NO.	DESCRIPTION	Qty
			11	MUFFLER	1
			12	RECOIL STARTER	1
3	LUG GROUND	1	13	COCK ASSY.FUEL	1
4	VOLTMETER	1	14	AIR CLEANER	1
5	BRACKET,RR.,MOTOR	1	15	CHOKE ROD	1
6	230 V ~ 50 Hz Socket	1	16	TUBE,LPG	1
7	AC CIRCUIT BREAKER	1	17	FRAME COMP	1
8	MOTOR ASSY.,STARTING	1	18	TANK TOP COMP,FUEL	1
9	CAP ASSY,OIL FILLER	1	19	REDUCTOR ASSY	1
10	ENGINE SWITCH	1	20	MUFFLER COMP	1

WARNING: DO NOT exceed the generator's wattage/ampere capacity. Our products are continuously being changed and improved. Every effort has been made to ensure that information in the manual is accurate and up to date. However, we reserve the right to change, alter or otherwise improve the product and this manual at any time without prior notice.

REDUCTOR ASSY

Operation instruction of REDUCTOR ASSY

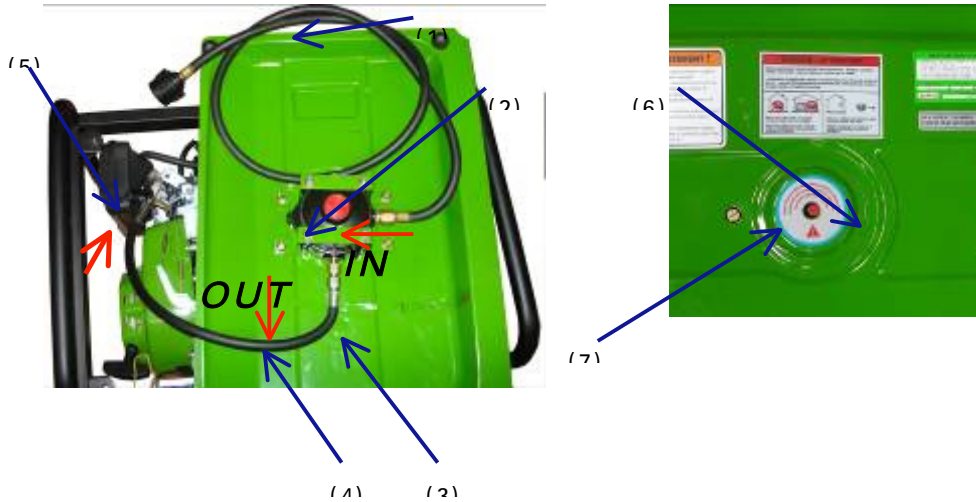

NO.	DESCRIPTION	Qty	NO.	DESCRIPTION	Qty
1	High-pressure intake tube(1000mm)	1	5	Mix device(the same as carburetor)	1
2	REDUCTOR ASSY	1	6	LPG denser device (bottom)→mounted onto REDUCTOR valve	1
3	TANK TOP COMP,FUEL	1	7	LPG air-pressure adjusting bottom→mounted onto REDUCTOR valve	1
4	Low-pressure outlet tube	1			

Instruction on LPG denser device (bottom)

To develop cold start performance of LPG generator unit, the air REDUCTOR ASSY includes one LPG denser device (bottom), the detailed operation of the bottom is as below.

When start the cold LPG generator unit, open the valve of LPG tank, close the resistance air valve handle, press the LPG denser device (bottom) lightly, and keep 1-2 seconds, then stop. Start the engine normally, and after finish start, please open resistance air valve handle.

CAUTION

- The bottom only does work after turning on the LPG tank valve, if start normally, no need press the bottom, or it will cause generator unit work abnormally.
- When press the bottom, the keeping time must not over 2 seconds, otherwise it is not good for start;
- No need to press the bottom at every start, only need to use when the first start of the cold generator unit or when need to change Gas;
- Prohibit adjusting the regulation bottom.

Controls and Features

Power Panel

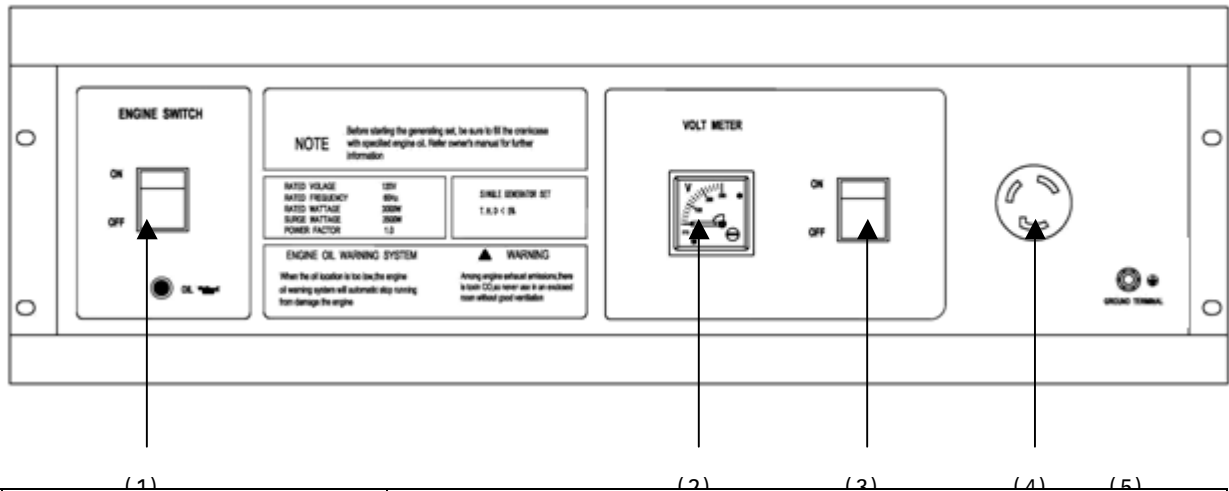



NO.	ITEM	EXPLAIN
(1)	Engine Switch	Flip the switch to the "On" position and pull the recoil starter to start the generator. Turn to the "Off" position to turn off the generator.
(2)	VOLTMETER	Index style voltage meter, when running the generator unit, it shows the current voltage; when turn off the generator unit, the reading returns to "0".
(3)	AC CIRCUIT BREAKER	Protects the generator against electrical overload.
(4)	230 V Socket	230 V ~ 50 Hz, Continuous Power 2.2 kW, Maximum Power 2.5 kW
(5)	LUG GROUND	Consult an electrician for local grounding regulations.

Controls and Features

Parts Included

Your **CETL***** LPG** Powered Generator ships with the following parts:

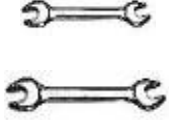
	DESCRIPTION	QTY
	Flat Head Screwdriver	1
	Spark Plug Wrench	1
	Wrench, 8×10 17×19	1

Assembly

Assembly

Your generator requires some assembly. This unit ships from our factory without oil. It must be properly serviced with fuel and oil before operation.

Remove the Generator from the Shipping Carton

1. Set the shipping carton on a solid, flat surface.
2. Remove everything from the carton except the generator.
3. Carefully cut each corner of the box from top to bottom. Fold each side flat on the ground to provide a surface area to install the wheel kit and support leg.

Install the Wheel Kit

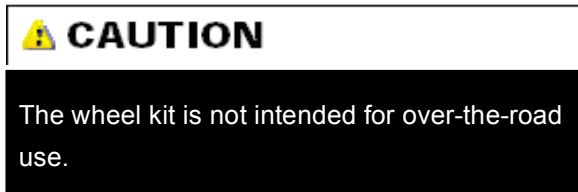

You will need the following tools to install the wheels:

- 12 mm wrench
- Socket wrench with a 12 mm socket Pliers

1. Before adding oil to the engine, tip the generator slowly so that the engine side is up.
2. Attach the axle to the bottom of the frame with four mounting bolts and nuts.
3. Slide a wheel onto the axle.
4. Place a washer on the end.
5. Install the cotter pin through the hole on the end of the axle.
6. Carefully bend the legs of the cotter pin back around the axle.
7. Repeat steps 3-6 to attach the second wheel.

Install the Support Leg

1. Attach the rubber vibration mount to the support leg with a cap screw (M8x20) and lock nut (M8).

2. Attach the support leg to the generator frame with cap screws (M8x30) and lock nuts (M8).
3. Tip the generator slowly so that it rests on the wheels and support leg.

Install the Handle

1. Place the handle over the mounting channel on the frame.
2. Secure the handle to the frame using the two handle bolts.
3. Place a lock nut (M8) on the end of each bolt and fasten securely. DO NOT over tighten the lock nuts.

Install the Spark Arrester (optional)

Insert the spark arrester screen into the muffler outlet. Secure the spark arrester by placing the cover plate over the end of the screen, with the lettering facing outward.

Secure the cover plate with the two screws and lock washers provided with the spark arrester kit.

Add Engine Oil

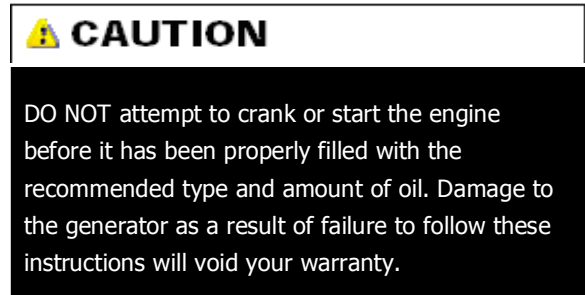

1. Place the generator on a flat, level surface.
2. Remove oil fill cap/dipstick to add oil.
3. Add 0.63 qt (0.6 L) of oil and replace oil fill cap/dipstick.
4. Check engine oil level daily and add as needed.

Assembly

CAUTION

The engine is equipped with a low-oil-shutoff and the will stop when the oil level in the crankcase falls below the threshold level.



NOTE

Check oil often during the break-in period. Refer to the Maintenance section for recommended service intervals.



NOTE

The generator rotor has a sealed, pre-lubricated ball bearing that requires no additional lubrication for the life of the bearing.

Add LPG Fuel

1. Use clean, fresh, regular LPG with LPG gas pressure area: 0.2~0.7MPa.
2. DO NOT mix oil with fuel.
3. DO NOT use gasoline as fuel.
4. Clean the area around the fuel cap.
5. Connect LPG tube on LPG tank and fasten it.
6. Turn the LGP tank valve to "ON" position - full open.
7. Screw on the trachea tie-in
8. Check the LPG to see if it is leaking and then guarantee it.

CAUTION

DO NOT mix oil with fuel.
DO NOT use gasoline as fuel.
Clean the area around the fuel cap.
Connect LPG tube on LPG tank and fasten it.
Turn the LGP tank valve to "ON" position - full open.
Screw on the trachea tie-in
Check the LPG to see if it is leaking and then guarantee it.
When the air-pressure lower than standard range, please change LPG tank.

Grounding

Your generator must be properly connected to an appropriate ground to help prevent electric shock.

WARNING

Failure to properly ground the generator can result in electric shock.

A ground terminal connected to the frame of the generator has been provided on the power panel. For remote grounding, connect of a length of heavy gauge (14 AWG minimum) copper wire between the generator ground terminal and a copper rod driven into the ground. We strongly recommend that you consult with a qualified electrician to ensure compliance with local electrical codes.

Operation

Operation

Generator Location

Please consult your local authority. In some areas, generators must be registered with the local utility. Generators used at construction sites may be subject to additional rules and regulations. This generator must have at least five feet of clearance from combustible material. Leave at least three feet of clearance on all sides of the generator to allow for adequate cooling, maintenance and servicing. Place the generator in a well-ventilated area. DO NOT place the generator near vents or intakes where exhaust fumes could be drawn into occupied or confined spaces. Carefully consider wind and air currents when positioning generator.

WARNING

1. When using the LPG generator, please be sure that there are some distance between LPG tank and LPG generator, to prevent unnecessary danger because of high temperature surface of LPG tank;
2. When using the unit, please check the surface temperature of LPG tank.

Grounding

The generator system ground connects the frame to the ground terminals on the power panel. The system ground is connected to the AC neutral wire.

Surge Protection

CAUTION

Voltage fluctuation may impair the proper functioning of sensitive electronic equipment.

Electronic devices, including computers and many programmable appliances use components that are designed to operate within a narrow voltage range and may be affected by momentary voltage fluctuations.

While there is no way to prevent voltage fluctuations, you can take steps to protect sensitive

electronic equipment.

1. *Install UL 1449, CSA-listed, plug-in surge suppressors on the outlets feeding your sensitive equipment.*

Surge suppressors come in single- or multi-outlet styles. They're designed to protect against virtually all shortduration voltage fluctuations.

2. *Obtain an Uninterruptible Power Supply (UPS) device.*

Most UPS devices come with a rechargeable battery between the electronic equipment and power supply source. The device buffers the voltage and protects against virtually all shortduration voltage fluctuations.

Starting the Engine

1. Make certain the generator is on a flat, level surface.
2. Disconnect all electrical loads from the generator. Never start or stop the generator with electrical devices plugged in or turned on.
3. Connect LPG tube to the LPG tank, and then open the LPG valve slowly, till it totally open (to insure no LPG leakage).
4. Move the choke lever to the "Choke" position.
5. Press the denser bottom of the REDUCTOR ASSY and keep 1~2 seconds;
6. Pull the starter cord slowly until resistance is felt and then pull rapidly
7. As engine warms up, move the choke lever to "Run".

NOTE

If the engine starts but does not run, make certain that the generator is on a flat, level surface. The engine is equipped with a low oil sensor that will prevent the engine from running when the oil level falls below a critical threshold.

Connecting Electrical Loads

1. Let the engine stabilize and warm up for a few minutes after starting
2. Plug in and turn on the desired 230 Volt AC single phase.

Prohibit using CNG, NG or gasoline as fuel.

Operation

Stopping the Engine

1. Turn off and unplug all electrical loads. Never start or stop the generator with electrical devices plugged in or turned on.
2. Let the generator run at no-load for several minutes to stabilize internal temperatures of the engine and generator.
3. Turn the ignition switch to the "Off" position.
4. Turn the fuel valve to the "Off" position.

Do Not Overload Generator Capacity

Follow these simple steps to calculate the running and starting watts necessary for your purposes.

1. Select the electrical devices you plan on running at the same time.
2. Total the running watts of these items. This is the amount of power you need to keep your items running.
3. Identify the highest starting wattage of all devices identified in step 1. Add this number to the number calculated in step 2.
2. Surge wattage is the extra burst of power needed to start some electric driven equipment. Following the steps listed under "Power Management" will guarantee that only one device will be starting at a time.

Power Management

Use the following formula to convert voltage and amperage to watts:

$$\text{Volts} \times \text{Amps} = \text{Watts}$$

To prolong the life of your generator and attached devices, follow these steps to add electrical load:

1. Start the generator with no electrical load attached.
2. Allow the engine to run for several minutes to stabilize.
3. Plug in and turn on the first item. It is best to attach the item with the largest load first.
4. Allow the engine to stabilize.
5. Plug in and turn on the next item.
6. Allow the engine to stabilize.
7. Repeat steps 5-6 for each additional item.

NOTE

Never exceed the generator capacity when adding loads.

Wattage Reference Chart

Use the chart to determine approximate wattage requirements for your equipment.

NOTE

Starting watts can exceed three times the running watts. The values in the following table are approximate. Refer to your tool or appliance for actual wattage consumption.

Item	Running Watts	Starting Watts
Essentials		
Light Bulb 100W	100	
Refrigerator/Freezer	1200	2400
Freezer	500	500
Sump Pump	600	1800
Well Pump 1 HP	2000	4000
Water Heater	4000	
Security System	180	
AM/FM Radio	300	
Garage Door Opener 1/2 HP	500	600
Battery Charger 12V DC	110	
Heating/Cooling		
Air Conditioner 12000 BTU	1700	2500
Fan	300	600
Furnace Fan 1/3 HP	1200	2000
Home Appliances		
Microwave 1000W	1000	
Electric Range - One Element	1500	
Electric Skillet	1250	
Coffee Maker	1500	
Clothes Washer	1200	
Entertainment		
CD/DVD Player	100	
VCR	100	
Stereo Receiver	450	
Television 27"	500	
PC with 15" Monitor	800	
Job Site		
Belt Sander 3"	1000	1500
Bench Grinder 6"	700	1500
Circular Saw	1500	1500
Compressor 1 1/2 HP	2500	2500
Edge Trimmer	500	500
Hand Drill 1/2"	1000	1000
Lawn Mower	1200	1800
Paint Sprayer	600	1200
Table Saw	2000	2000

Maintenance

Maintenance

The owner/operator is responsible for all periodic maintenance.

WARNING

Never operate a damaged or defective generator.

WARNING

Tampering with the factory set governor will void your warranty.

WARNING

Improper maintenance will void your warranty.

Complete all scheduled maintenance in a timely manner. Correct any issue before operating the generator.

Engine Maintenance

To prevent accidental starting, remove and ground spark plug wire before performing any service.

Oil

Change oil when the engine is warm. Refer to the oil specification to select the proper grade of oil for your operating environment.

1. Remove the oil drain plug with a 15 mm socket and extension.
2. Allow the oil to drain completely.
3. Replace the drain plug.
4. Remove oil fill cap/dipstick to add oil.
5. Add 0.63 qt (0.6 L) of oil and replace oil fill cap/dipstick.

6. Dispose of used oil at an approved waste management facility.

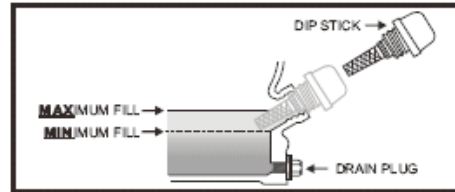

Spark Plugs

1. Remove the spark plug cable from the spark plug.
2. Use the spark plug tool that shipped with your generator to remove the plug.
3. Inspect the electrode on the plug. It must be clean and not worn to produce the spark required for ignition.
4. Make certain the spark plug gap is 0.7 - 0.8mm (0.028 - 0.031 in.).
5. Refer to the spark plug recommendation chart when replacing the plug.
6. Carefully thread the plug into the engine.
7. Use the spark plug tool to firmly install the plug.
8. Attach the spark plug wire to the plug.

Air Filter

1. Remove the snap-on cover holding the air filter to the assembly.
2. Remove the foam element.
3. Wash in liquid detergent and water. Squeeze thoroughly dry in a clean cloth.
4. Saturate in clean engine oil.
5. Squeeze in a clean, absorbent cloth to remove all excess oil.
6. Place the filter in the assembly.
7. Reattach the air filter cover and snap in place.

Maintenance

Spark Arrester (if installed)

1. Allow the engine to cool completely before servicing the spark arrester.
2. Remove the two screws holding the cover plate which retains the end of the spark arrester to the muffler.
3. Remove the spark arrester screen.
4. Carefully remove the carbon deposits from the spark arrester screen with a wire brush.
5. Replace the spark arrester if it is damaged.
6. Position the spark arrester in the muffler and attach with the two screws.

Cleaning

 CAUTION
DO NOT spray engine with water.
Water can contaminate the fuel system.

Use a damp cloth to clean exterior surfaces of the engine.

Use a soft bristle brush to remove dirt and oil.

Use an air compressor (25 PSI) to clear dirt and debris from the engine.

Adjustments

The air-fuel mixture is not adjustable.

Tampering with the governor can damage your generator and your electrical devices and will void your warranty.

Maintenance Schedule

Follow the service intervals indicated in the schedule below.

Service your generator more frequently when operating in adverse conditions.

Every 8 hours or daily
Check oil level
Clean around air intake and muffler
First 5 Hours
Change oil
First 10 hours
Check/Adjust Valve Clearance *
Every 50 hours or every season
Clean air filter
Change oil if operating under heavy load or in hot environments
Every 100 hours or every season
Change oil
Clean/Adjust spark plug
Check/Adjust valve clearance *
Clean spark arrester
Clean fuel tank and filter *
Every 3 years
Replace fuel line

* To be performed by knowledgeable, experienced owners or Champion Power Equipment certified service dealers

Generator Maintenance

Make certain that the generator is kept clean and stored properly. Only operate the unit on a flat, level surface in a clean, dry operating environment. DO NOT expose the unit to extreme conditions, excessive dust, dirty, moisture or corrosive vapors.

 CAUTION
DO NOT use a garden hose to clean the generator.
Water can enter the generator through the cooling slots and damage the generator windings.

Use a damp cloth to clean exterior surfaces of the generator.

Use a soft bristle brush to remove dirt and oil.

Use an air compressor (25 PSI) to clear dirt and debris from the generator.

Inspect all air vents and cooling slots to ensure that

Storage

they are clean and unobstructed.

Storage

The generator should be started at least once every 14 days and allowed to run for at least 20 minutes.

For longer term storage, please follow these guidelines.

Engine Storage

1. Allow the engine to cool completely before storage.
2. Clean the engine according to the instructions in the Maintenance section.
3. Drain all fuel completely from the fuel line and carburetor to prevent gum from forming.
4. Add a fuel stabilizer into the fuel tank.
5. Change the oil.
6. Remove the spark plug and pour about ½ ounce of oil into the cylinder. Crank the engine slowly to distribute the oil and lubricate the cylinder.
7. Reattach the spark plug.

Generator Storage

1. Allow the generator to cool completely before storage.
2. Turn off the fuel supply at the fuel valve.
3. Clean the generator according to the instructions in the Maintenance section.
4. Store the unit in a clean, dry area.
5. Store in a clean, dry place out of direct sunlight.

Specifications

Specifications

Engine Specifications

Engine 208 cc OHV CPE
EPA certified

Generator Specifications

Running Wattage 2200 Watts
Starting Wattage 2500Watts
AC Load 230V
Phase Single
Frequency 50 Hz

Fuel

Use clean, fresh, regular LPG with LPG gas pressure area:0.2~0.7MPa.

Oil

Oil capacity is 0.63 qt (0.6 L).

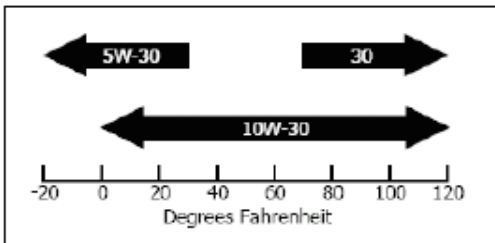

Spark Plugs

Your generator comes equipped with a $\frac{3}{4}$ " long reach plug (18 mm)
Intermittent use (less than 1 hour/month) or colder temperatures (below 60°F)
NGK B4ES or STAR F6TC

Moderate use (less than 3 hours/month) or Seasonal temperatures (50-80°F)
NGK B4ES or STAR F6TC

Extreme use (continuous) or hot climates (80-100°F)
NGK B4ES or STAR F6TC

Make certain the spark plug gap is 0.7 - 0.8mm (0.028 - 0.031 in.).

Valve Clearance

Intake 0.10-0.12mm (0.004 – 0.005 in.)
Exhaust 0.15-0.17mm (0.006 – 0.007 in.)

Specifications

Parts Diagram

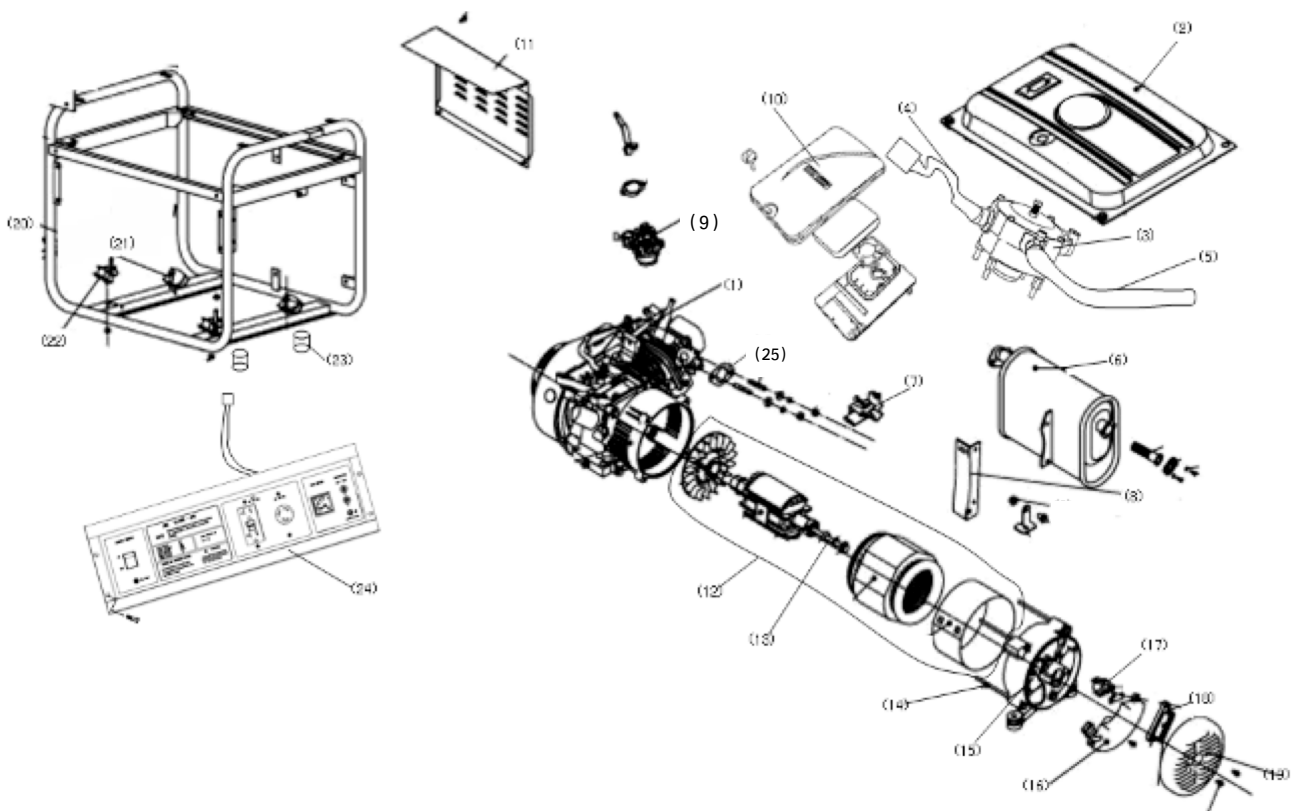

Specifications

Parts List

NUMBER	DESCRIPTION	QTY
1	ENGINE ASSY	1
2	TANK TOP COMP,FUEL	1
3	CONNECT VALVE ASSY	1
4	MINUS PRESS DUCT	1
5	LOW-PRESSURE OUTTAKE TUBE	1
6	MUFFLER COMP	1
7	SUPPORTING PLSTE	1
8	MUFFLER STAY	1
9	CARBURETOR ASSY	1
10	AIR/C	1
11	PROTR,OUT MUFFLER	1
12	MOTOR ASSY.,STARTING(3.0KW)	1
13	BOLT (ROTOR)8×220	1
14	BOLT FLANGE(STATOR) 6×165	4
15	GENERATOR STAY	1
16	VOLTAGE REGULATOR(3KW)	1
17	BRUSH ASSY	1
18	CONNECTION FLAT	1
19	BRACKET,RR.,MOTOR	1
20	FRAME COMP	1
21	BOTTOM RUBBER A	2
22	BOTTOM RUBBER B	2
23	RUBBER,BOTTOM (NUT)	4
24	CONTROL PANEL ASSY	1
25	GASKET,MUFFLER	2

Troubleshooting

Troubleshooting

Problem	Cause	Solution
Generator will not start	No fuel	Add fuel
	Faulty spark plug	Replace spark plug
	Unit loaded during start up	Remove load from unit
Generator will not start; Generator starts but runs roughly	Low oil level	Fill crankcase to the proper level Place generator on a flat, level surface
	Choke in the wrong position.	Adjust choke.
	Spark plug wire loose	Attach wire to spark plug
Generator shuts down during operation	Out of fuel	Fill fuel tank
	Low oil level	Fill crankcase to the proper level. Place generator on a flat, level surface
Generator cannot supply enough power or overheating	Generator is overloaded	Review load and adjust. See "Power Management"
	Insufficient ventilation	Check for air restriction. Move to a well ventilated area
No AC output	Cable not properly connected	Check all connections
	Connected device is defective	Replace defective device
	Circuit breaker is open	Reset circuit breaker
	Capacitor defective	Replace capacitor (Service Center)
	Faulty brush assembly	Replace brush assembly (Service Center)
	Faulty AVR	Replace AVR (Service Center)
	Loose wiring	Inspect and tighten wiring connections
	Other	Contact the help line.
Generator gallops	Engine governor defective	Contact the help line
Repeated circuit breaker tripping	Overload	Review load and adjust. See "Power Management"
	Faulty cords or device	Check for damaged, bare or frayed wires. Replace defective device

Contact Information's

Ressichem International
Home & Industrial Power Tools Division
225-228 Masood Chamber, New Chali,
Shahra-e-Liaquat, Karachi, Pakistan
Tel: 021-2210463
Fax:021-2210640
E: ehell@ressichem.com
W: www.ressichem.com

Notes

Notes