

OPERATION

5. MOWING

- While using your lawn mower always wear substantial closed, heavy footwear and long trousers.
- Make sure the lawn is clear of sticks, stones, wire and debris; they could be thrown by the blade.
- Before using the lawn mower and after any impact, check for signs of wear or damage and repair as necessary.
- Replace a worn or damaged blade together with the blade bolt to preserve balance.

Lawn Mowing Tips

Start mowing the edge of the lawn and work along making sure to overlap each pass by a few centimetres.

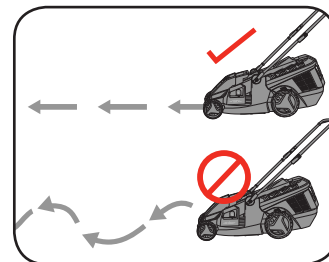
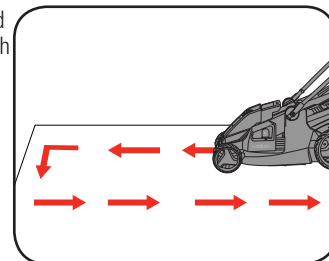

When mowing long grass be sure to not overload the motor. First cut with the highest cutting height and then to the desired height. This will help reduce the load.

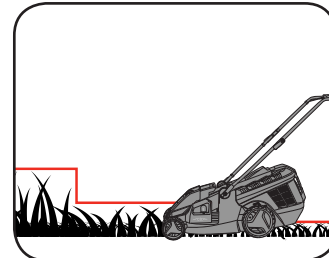

MAINTENANCE

WARNING! ALWAYS ENSURE THE LAWN MOWER BLADE HAS COMPLETELY STOPPED, REMOVE SAFETY KEY, BATTERY AND GRASS CATCHER PRIOR TO ANY MAINTENANCE.

Removing and Fitting the Blade

CAUTION! ALWAYS USE GLOVES WHEN HANDLING THE BLADE. SHARP EDGES COULD CAUSE INJURY.

- To remove the blade bolt, hold the blade firmly and with a 12mm spanner loosen the blade bolt by turning it anti-clockwise.
- Remove the blade bolt, washer and blade.

Replace the metal blade after 50 hours mowing or 2 years whichever is sooner. If the blade is cracked or damaged replace it with a new one.

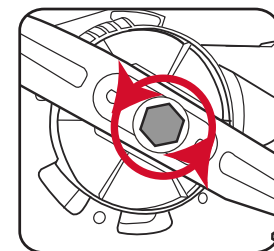

Cleaning, Maintenance and Storage

- Keep all nuts, bolts and screws tight to be sure the lawn mower is in a safe working condition.
- Check the catcher frequently for wear or deterioration.
- Replace worn or damaged parts for safety.
- Only use the replacement blade and blade bolt specified for this product.
- Be careful during adjustments of the lawn mower to prevent entrapment of the fingers between moving blade and fixed parts of the machine.
- When not in use, the mower should be stored in a dry, frost-free location, out of reach of children. If the housing of the mower requires cleaning, do not use solvents but a moist soft cloth and brush only.
- Frequently check the wheel threads are firm and tight.

Note: Ozito Industries will not be responsible for any damage or injuries caused by the repair of the trimmer by an unauthorised person or by mishandling of the trimmer. This tool is designed for DIY use - use in commercial or industrial environments will void the warranty.

IMPORTANT! DO NOT MOW WITH POOR VISIBILITY CONDITIONS, IN THE RAIN OR WHEN GRASS IS WET.

TROUBLESHOOTING

Problem	Cause	Remedy
Mower is not starting	Possible clogging	Check underneath the mower and clear out as necessary
	Battery is low in charge	Charge battery
	Battery not inserted properly	Insert battery pack correctly
	Grass too long	Raise the cutting height to reduce starting load
Mower is hard to push	Safety key not inserted correctly	Fit correctly
	Height of cut too low	Raise cutting height
Motor stops while cutting	Cutting blade blunt	Replace blade
	Possible clogging	Check underneath the mower and clear out as necessary
	Grass too long	Raise the cutting height and walk slower
	Grass too dense	Raise the cutting height and walk slower and cut more frequently
	Wet grass	Wait until the grass dries before mowing
Mower is not catching grass properly	Height of cut too low	Raise the cutting height
	Wet grass	Wait until the grass dries before mowing
Mower vibrating	Bent or damaged blade	Replace blade

SPARE PARTS

Spare parts can be ordered from the Special Orders Desk at your local Bunnings Warehouse or Homebase store. For further information, or any parts visit www.ozito-diy.co.uk or contact Ozito Customer Service: Great Britain: 0151 294 4488 Ireland: 1850 882711 E-mail: info@ozito-diy.co.uk

BATTERY AND CHARGER SAFETY WARNINGS

THIS MANUAL CONTAINS IMPORTANT SAFETY AND OPERATING INSTRUCTIONS FOR YOUR BATTERY CHARGER.

- Before using the charger read all instructions and cautionary markings on the charger, battery pack and the product using the battery pack.
- This charger is not intended for any uses other than charging rechargeable batteries. Any other use may result in risk of fire, electric shock or electrocution.
- Do not place any object on top of the charger or place the charger on a soft surface that may result in excessive internal heat. Place the charger in a position away from any heat source.
- To reduce risk of damage to the electric plug and cord, pull by the plug rather than the cord when disconnecting the charger.
- Make sure the cord is located so that it will not be stepped on, tripped over, or otherwise subjected to damage or stress.
- An extension cord should not be used unless absolutely necessary. Use of an improper extension cord could result in the risk of fire, electric shock or electrocution.
- Do not operate the charger if it has received a sharp blow, been dropped or otherwise damaged in any way. Have it checked by an electrician or power tool repairer.
- Do not disassemble charger. Take it to an electrician or power tool repairer when service or repair is required. Incorrect reassembly may result in a risk of electric shock, electrocution or fire.
- To reduce risk of electric shock, unplug the charger from the outlet before attempting any cleaning. Removing the battery pack will not reduce this risk.
- Never attempt to connect 2 chargers together.
- DO NOT store or use the tool and battery pack in locations where the temperature may reach or exceed 40°C (such as inside sheds or metal buildings in summer).
- The charger is designed to operate on standard household electrical power (240 volts). Do not attempt to use it on any other voltage!
- The battery pack is not fully charged out of the carton. First read the safety instructions and then follow the charging notes and procedures.
- The longest life and best performance can be obtained if the battery pack is charged when the air temperature is between 18 - 24°C. Do not charge the battery pack in an air temperature below 10°C or above 40°C. This is important and will prevent damage to the battery pack.
- Do not incinerate the battery pack even if it is seriously damaged or is completely worn out. The battery can explode in a fire.
- Never attempt to open the battery pack for any reason. If the plastic housing of the battery pack breaks or cracks, immediately discontinue use and do not recharge.
- During charging, the battery must be placed in a well ventilated area.

DESCRIPTION OF SYMBOLS

V	Volts	Hz	Hertz
~	Alternating current	W	Watts
dc/≡	Direct current	Ø	Diameter
mA	Milliamperes	No	No load speed
/min	Revolutions or reciprocation per minute	□	Double insulated
Nm	Newton Meters	📖	Read instruction manual
130°C	Thermal cut-out protection	🔒	Pull out Safety Key before carry out any repair work
🏠	Indoor use only	⚠️	Warning
🔋	Lithium Ion- battery	🔥	Do not use or store battery in temperatures exceeding 50°C
♻️	Recycle battery	🚫	Do not put in the rubbish
🚫	Do not incinerate	🚫	Do not get battery wet
⚠️	Always keep the lawnmower on the ground when mowing. Lifting or lifting the lawnmower may cause stones to be thrown out.		
🚫	Keep bystanders away. Do not mow whilst people especially children or pets are in the mowing area.		
🚫	Beware of severing toes or hands. Do not put hands or feet near a rotating blade.		
🚫	Blade continues to rotate after the machine is switched off. Wait until all machine components have completely stopped before touching them.		
🚫	Do not mow in the rain or leave the lawnmower outdoors while raining.		

ELECTRICAL SAFETY

WARNING! When using mains-powered tools, basic safety precautions, including the following, should always be followed to reduce risk of fire, electric shock, personal injury and material damage.

Read the whole manual carefully and make sure you know how to switch the tool off in an emergency, before operating the tool. Save these instructions and other documents supplied with this tool for future reference. Before you connect the charger to the mains supply make sure that the data on the rating plate are identical to the mains data.

⚡ This tools charger is double insulated, therefore no earth wire is required.

If the supply cord is damaged, it must be replaced by an electrician or a power tool repairer in order to avoid a hazard.

GENERAL POWER TOOL SAFETY WARNINGS

WARNING! Read all safety warnings and all instructions. Failure to follow the warnings and instructions may result in electric shock, fire and/or serious injury. Save all warnings and instructions for future reference. The term "power tool" in the warnings refers to your mains-operated (corded) power tool or battery-operated (cordless) power tool.

- Work area safety**
 - Keep work area clean and well lit. Cluttered or dark areas invite accidents.
 - Do not operate power tools in explosive atmospheres, such as in the presence of flammable liquids, gases or dust. Power tools create sparks which may ignite the dust or fumes.
 - Keep children and bystanders away while operating a power tool. Distractions can cause you to lose control.

- Electrical safety**
 - Power tool plugs must match the outlet. Never modify the plug in any way. Do not use any adaptor plugs with earthed (grounded) power tools. Unmodified plugs and matching outlets will reduce the risk of electric shock.
 - Avoid body contact with earthed or grounded surfaces, such as pipes, radiators, ranges and refrigerators. There is an increased risk of electric shock if your body is earthed or grounded.
 - Do not expose power tools to rain or wet conditions. Water entering a power tool will increase the risk of electric shock.
 - Do not abuse the cord. Never use the cord for carrying, pulling or unplugging the power tool. Keep cord away from heat, oil, sharp edges or moving parts. Damaged or entangled cords increase the risk of electric shock.
 - When operating a power tool outdoors, use an extension cord suitable for outdoor use. Use of a cord suitable for outdoor use reduces the risk of electric shock.
 - If operating a power tool in a damp location is unavoidable, use a residual current device (RCD) protected supply. Use of an RCD reduces the risk of electric shock.

- Personal safety**
 - Stay alert, watch what you are doing and use common sense when operating a power tool. Do not use a power tool while you are tired or under the influence of drugs, alcohol or medication. A moment of inattention while operating power tools may result in serious personal injury.
 - Use personal protective equipment. Always wear eye protection. Protective equipment such as dust mask, non-slip safety shoes, hard hat, or hearing protection used for appropriate conditions will reduce personal injuries.
 - Prevent unintentional starting. Ensure the switch is in the off-position before connecting to power source and/or battery pack, picking up or carrying the tool. Carrying power tools with your finger on the switch or energising power tools that have the switch on invites accidents.
 - Remove any adjusting key or wrench before turning the power tool on. A wrench or a key left attached to a rotating part of the power tool may result in personal injury.
 - Do not overreach. Keep proper footing and balance at all times. This enables better control of the power tool in unexpected situations.

LAWN MOWER SAFETY WARNINGS

WARNING! If not used properly this lawn mower can be dangerous! This lawn mower can cause serious injury to the operator and others, the warnings and safety instructions must be followed to ensure reasonable safety and efficiency in using the lawn mower. The operator is responsible for following the warning and safety instructions in this manual and on the lawn mower. Never use the mower unless the catcher or guards provided by the manufacturer are in the correct position.

- 1) Training**
 - Read the instructions carefully. Be familiar with the controls and the proper use of the appliance.
 - Never allow children or people unfamiliar with these instructions to use the appliance. Local regulations may restrict the age of the operator.
 - Never mow while people, especially children, or pets are nearby.
 - The operator or user is responsible for accidents or hazards occurring to other people or their property.
 - Know your controls. Read the manual carefully. Learn how to stop the engine quickly in an emergency.

- 2) Preparation**
 - While mowing, always wear substantial footwear and long trousers.
 - Do not operate the appliance when barefoot or wearing open sandals.
 - Thoroughly inspect the area where the appliance is to be used and remove all stones, sticks, wires, bones, and other foreign objects. They could be thrown by the blade.
 - Before using, always visually inspect to see that the blades, blade bolts and cutter assembly are not worn or damaged. Replace worn or damaged blades and bolts in sets to preserve balance.

DAMAGED BLADES AND WORN BOLTS ARE MAJOR HAZARDS.

On multi-bladed appliances, take care as rotating one blade can cause other blades to rotate.

- 3) Operation**
 - Mow only in daylight or in good artificial light.
 - Avoid operating the appliance in wet grass, where feasible.
 - Always be sure of your footing on slopes.
 - Walk, never run.
 - For wheeled rotary mowers, mow across the face of slopes, never up and down.
 - Exercise extreme caution when changing direction on slopes.
 - Do not mow excessively steep slopes.
 - Use extreme caution when reversing or pulling the appliance towards you.
 - Never cut grass while walking backwards.
 - Stop the blade(s) if the appliance has to be tilted for transportation when crossing surfaces other than grass, and when transporting the appliance to and from the area to be mowed such as gravel drives, walks or roads.
 - Never operate the appliance with defective guards or shields, or without safety devices, for example deflectors and/or grass catchers, in place.

Note: Double insulation does not take the place of normal safety precautions when operating this tool. The insulation system is for added protection against injury resulting from a possible electrical insulation failure within the tool. The power supply for this products charger should be protected by a residual current device (rated at 30mA or less). A residual current device reduces the risk of electric shock.



2 X 18V LITHIUM ION

CORDLESS LAWN MOWER KIT

ORIGINAL INSTRUCTIONS

SPECIFICATIONS

Voltage: 18V x 2
Battery: 4.0Ah LI-ion
Charge Time: 80min
Cutting Diameter: 360mm
Cutting Heights: 25-75mm (6 levels)
No Load Speed: 3,000/min
Grass Catcher: 40 litre
Weight: 16.9kg

ozito-diy.co.uk

5 YEAR
REPLACEMENT WARRANTY

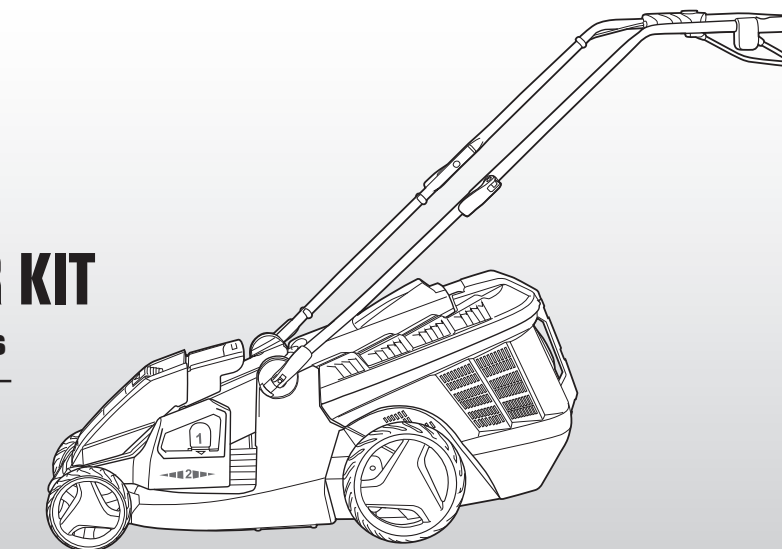

WHAT'S IN THE BOX



Cordless Lawn Mower



Safety Key

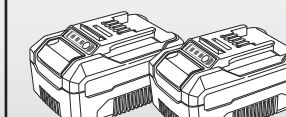

2 x 4.0Ah Batteries

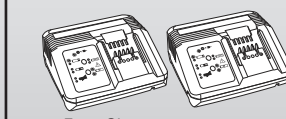

2 x Fast Charger

PXCLMK-418U

WARRANTY

All of our products undergo strict quality checks to ensure that they reach you in perfect condition. In the unlikely event that your device develops a fault, please contact our service department at the address shown on this guarantee card. You can also contact us by telephone using the customer service number shown. Please note the following terms under which guarantee claims can be made:

1. These warranty terms regulate additional warranty services, which the manufacturer mentioned below promises to buyers of its new products in addition to their statutory guarantee claims are not affected by this guarantee. Our guarantee is free of charge to you.

2. The warranty services only covers defects due to material or manufacturing faults on a product which you have bought from the manufacturer mentioned below are limited to either the rectification of said defects on the product or the replacement of the product, whichever we prefer. Please note that our devices are not designed for use in commercial, trade or professional applications. A guarantee contract will not be created if the device has been used by commercial, trade or industrial business or has been exposed to similar stresses during the guarantee period.

3. The following are not covered by our guarantee:
- Damage to the device caused by a failure to follow the assembly instructions or due to incorrect installation, a failure to follow the operating instructions (for example connecting it to an incorrect mains voltage or current type) or a failure to follow the maintenance and safety instructions or by exposing the device to abnormal environmental conditions or by lack of care and maintenance.
- Damage to the device caused by abuse or incorrect use (for example overloading the device or the use of unapproved tools or accessories), ingress of foreign bodies into the device (such as sand, stones or dust, transport damage), the use of force or damage caused by external forces (for example by dropping it).
- Damage to the device or parts of the device caused by normal or natural wear or tear or by normal use of the device.

4. Your Product is guaranteed for a period of 60 months from the original date of purchase and is intended for DIY (Do It Yourself) use only. Lithium Ion batteries and chargers are

covered by a 12 month warranty. Warranty excludes consumable parts. Guarantee claims should be submitted before the end of the guarantee period within two weeks of the defect being noticed. No guarantee claims will be accepted after the end of the guarantee period. The original guarantee period remains applicable to the device even if repairs are carried out or parts are replaced. In such cases, the work performed or parts fitted will not result in an extension of the guarantee period, and no new guarantee will become active for the work performed or parts fitted. This also applies if an on-site service is used.

IN ORDER TO MAKE A CLAIM UNDER THIS WARRANTY YOU MUST RETURN THE PRODUCT TO THE PLACE OF PURCHASE WITH YOUR REGISTER RECEIPT.

Please refer to the restrictions of this warranty concerning wearing parts, consumables and missing parts as set out in the service information in these operating instructions.

CUSTOMER SERVICE HELPLINE
GB: 0151 294 4488
IRL: 1850 882711
Ozito-diy.co.uk

KNOW YOUR PRODUCT

CORDLESS LAWN MOWER

- Wheels
- Batteries
- Battery Cover
- Height Adjustment Lever
- Lifting Handle
- Quick Adjustment Lever
- Lower Handle
- Cord Clips
- Lock-off Button
- Upper Handle
- Handle Securing Lever
- Start/Stop Lever
- Grass Catcher
- Grass Catcher Flap

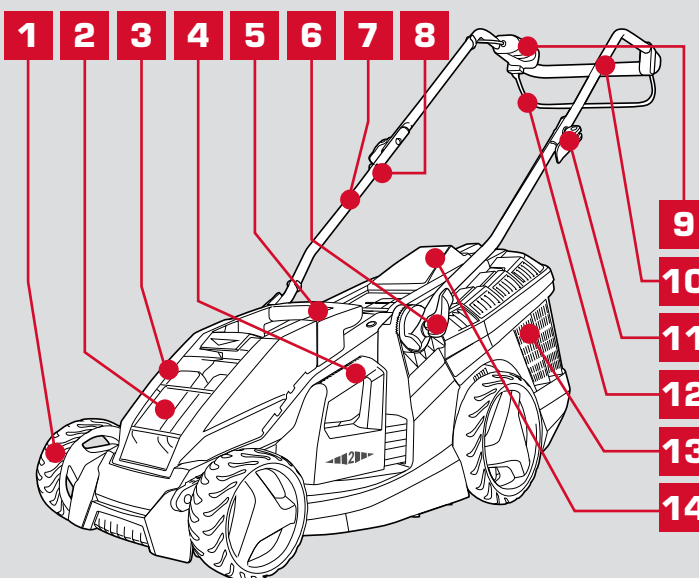

ACCESSORIES

- Battery Charge LED's
- Battery Charge Indicator Button
- Safety Key
- Charger LED's
- Charger

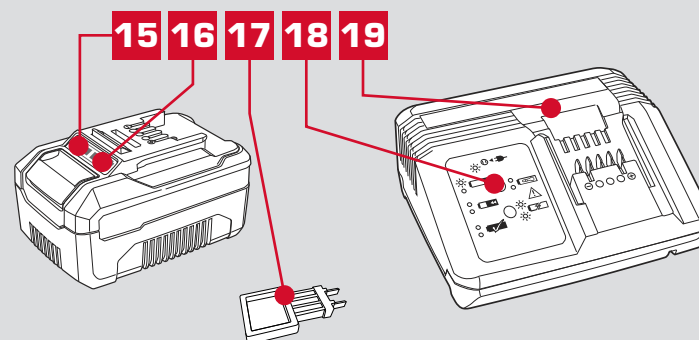

ONLINE MANUAL

Scan this QR Code with your mobile device to take you to the online manual.



SETUP & PREPARATION

1. ASSEMBLY

WARNING! ENSURE THE TOOL IS SWITCHED OFF AND BATTERIES ARE DISCONNECTED BEFORE PERFORMING ANY OF THE FOLLOWING TASKS.

Fitting the Rear Wheels

- Place the wheel onto the axle with the flat side facing towards the mower.
- Secure the wheel with a washer and p-clip.

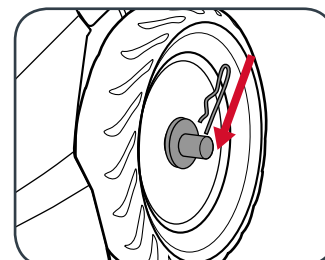
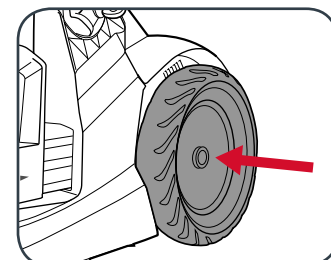

- Push the hub cap onto the centre of the wheel so it clicks into place.

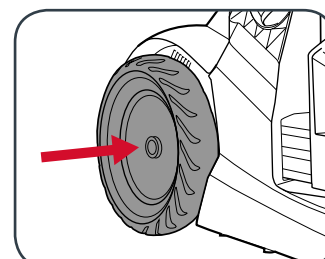
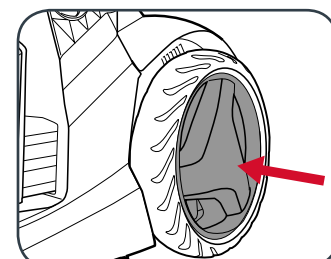

Fitting the Lower Handles

- Remove the quick adjustment lever and lower handle mount.
- The lower handle with the clip attached must be assembled on the right hand side. Make sure to insert the end without the rubber stop.

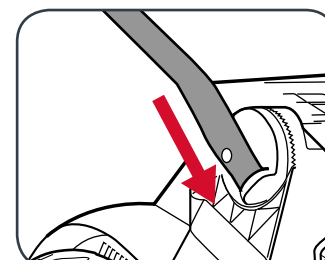
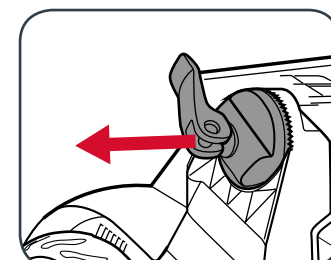

- Secure the lower handle with a washer and the quick adjustment lever.

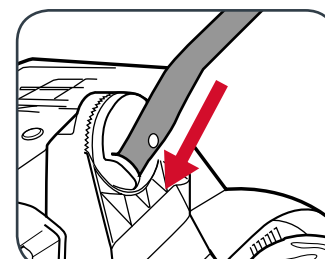
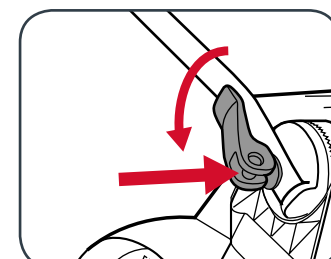

Fitting the Upper Handle

- Align the holes in the upper handle and lower handle. Care should be taken not to impinge cord.
- Place the handle securing lever bolt through the holes from the inside.

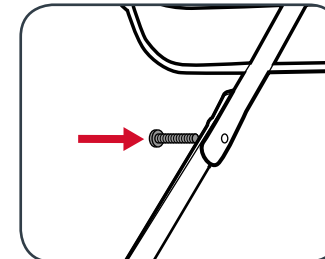
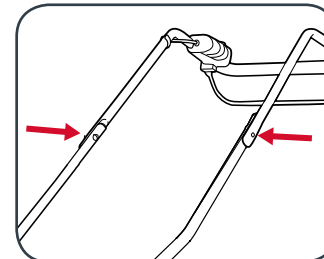

- Place a washer and the handle securing lever onto the bolt to secure in place.

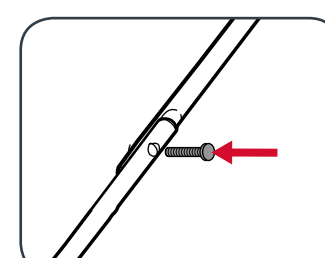
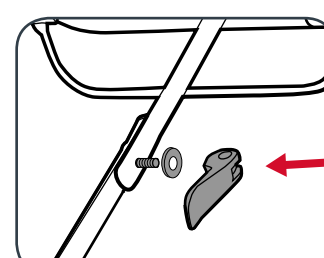

Adjusting the Handle

- Release both quick adjustment levers and rotate the handle into the desired position.
- Secure in place by tightening both quick adjustment levers.

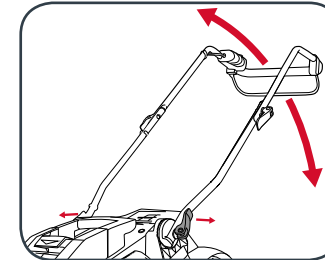

Securing the Cord

Ensure the cord follows the handle smoothly from the switch to the body of the mower.

- Secure cord into clip (a) on lower handle.
- Secure cord cover in position (b) using supplied cable tie.

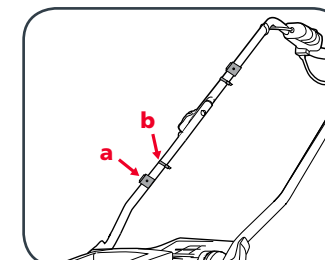

Note: Care should be taken not to impinge cord when folding down the handle.

Assembling the Grass Catcher

- Clip the two lower side halves together by pushing each lug firmly until it clicks in.
- Align the upper part and the lower halves and push each individual lug into its opposite location.

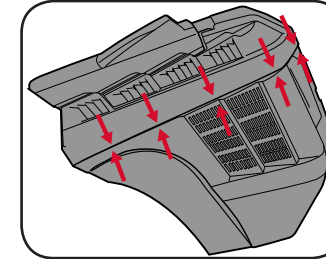
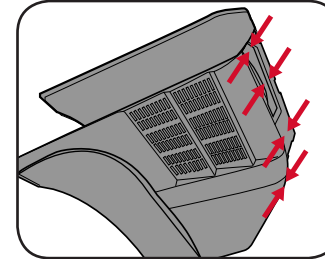

Fitting and Removing the Grass Catcher

IMPORTANT! ONLY FIT AND REMOVE THE CATCHER WHEN THE MOWER IS SWITCHED OFF AND THE MOTOR HAS COME TO A STOP.

- Lift up the grass catcher flap while guiding the catcher into the 2 hooks.
- Once the grass catcher is in place, the flap can be lowered.

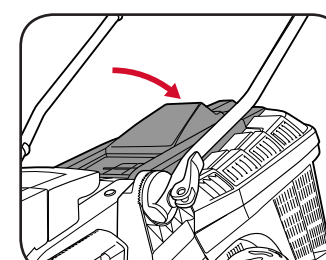
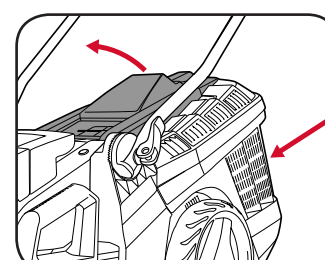

- To remove, raise the flap and lift the catcher out.

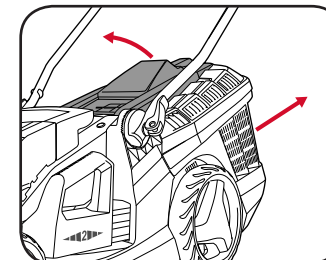

WARNING! WHEN FITTING THE GRASS CATCHER AFTER EMPTYING, ALWAYS ENSURE THERE IS NO BUILD UP OF GRASS IN THE GRASS CHUTE.

Grass Catcher Indicator

The grass catcher is fitted with an indicator flap at the rear of the catcher to help identify when to empty.

If the indicator flap is down while operating then the grass catcher is full and needs emptying.

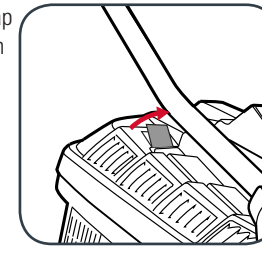

2. BATTERY & CHARGING

CAUTION! THE CHARGER FOR THIS PRODUCT SHOULD BE PROTECTED BY A RESIDUAL CURRENT DEVICE (RATED AT 30MA OR LESS).

Charging your lithium ion battery

The tool's battery has been shipped in a low charge condition, and requires charging prior to use.

Charging your lithium ion battery - Fast Charger

- Connect the charger into a mains power outlet.
- The charger LED will flash green showing power is being supplied to the charger.



- With the charger sitting on a flat surface, align the raised ribs on the battery with the recess in the charger and slide onto the charger ensuring a firm connection.
- The charger LED will illuminate red signifying that the battery is charging.

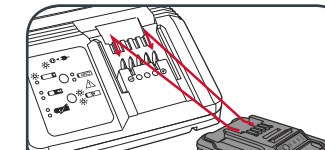

- The charger LED will illuminate green once the battery is charged.

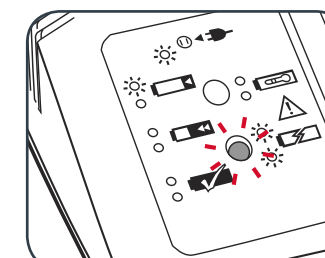
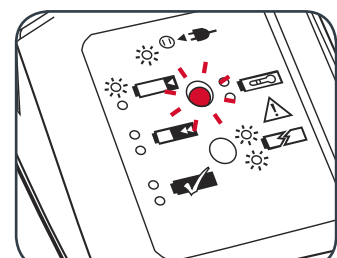
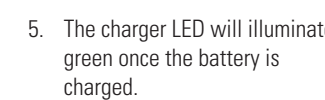

Charger LED Indicator

LED Indicator	Situation
GREEN (Flashing)	Stand By (no battery pack is inserted).
RED (Flashing)	Battery is charging (low charge).
RED (Illuminated)	Battery is charging (mid charge).
GREEN (Illuminated)	Battery is 85% - 100% Charged ready for use.
BOTH (Illuminated)	Battery pack is too hot or too cold (charging will begin automatically when battery reaches correct charging temperature).
BOTH (Flashing)	Defective battery. Never charge a defective battery pack! Remove battery pack from charger.

Battery Charge Indicator

The purchased battery is equipped with a battery charge indicator to show the state of the battery charge.

Press the charge indicator button and look to see which LED lights.

- Battery requires immediate charging
- Low state of charge, requires charging soon.
- Mid state of charge
- Full state of charge.

Note: The battery needs to be removed from the tool to check the state of charge.

Battery protection system

The tool is equipped with the battery protection system, which helps to ensure a long service life.

The output power automatically cuts off during operation when the tool and/or battery are placed under the following situations:

- When the tool is overloaded:** If this occurs, release the trigger switch and remove causes of overload, then pull the switch trigger again to restart.
- When the remaining battery capacity becomes low:** Recharge the battery pack.

Note: The battery protection system does not in any way damage the tool.

Note: The indicated capacity may be lower than the actual level during use or immediately after using the tool.

Note: Always use 2 batteries of same capacity and same charge state with the mower.

3. INSERTING & REMOVING THE BATTERIES

Inserting the Batteries into the Mower

Note: Always use 2 batteries of same capacity and same charge state with the mower.

- Pull the securing latch forward and open the battery cover.
- Slide two batteries of the same capacity and same charge state into the mower aligning the ribs so that they click into place.

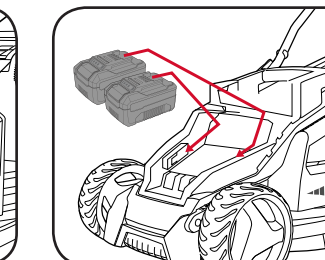
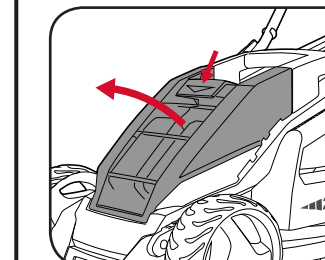

- Insert the safety key. (If the mower is not going to be used immediately, do not insert the safety key.)

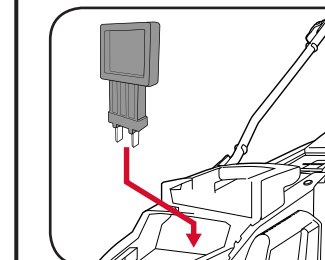

- Close the battery cover.

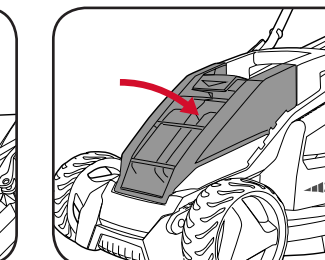

Removing the Batteries from the Mower

- Pull the securing latch forward and open the battery cover.

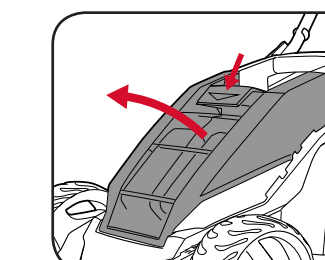

- Press the battery release tab and remove the batteries.

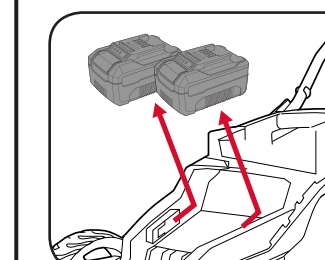

- Close the battery cover.

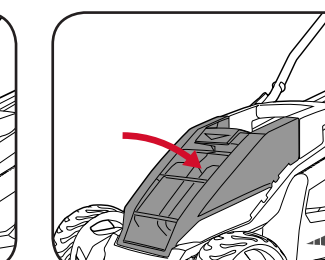

OPERATION

4. CONTROLS

Switching On and Off

To prevent accidental start up, the mower is fitted with a dual action switch.

- Press and hold the lock-off button.
- Pull the start/stop lever towards the handle to start the mower and then release the lock-off button.

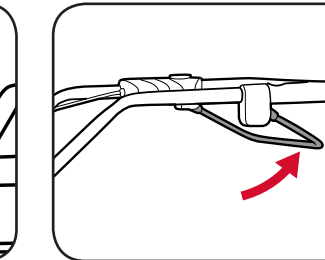
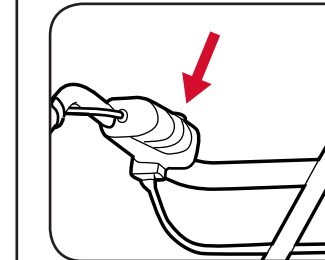

- Release the start/stop lever to stop the mower.

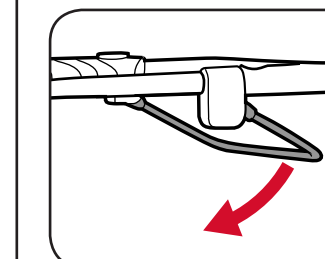

Adjusting the Cutting Height

The height adjustment lever provides 6 cutting heights from 25mm to 75mm.

- Push lever 1 outwards away from the mower body and hold to release the lever.
- Adjust 2 until the required cutting height is selected.
- Release lever 1 and check that it is securely seated in the required cutting height.

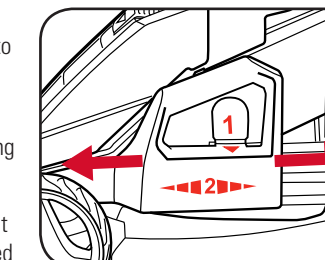

CAUTION! BE CAREFUL DURING CUTTING HEIGHT ADJUSTMENTS TO PREVENT ENTRAPMENT OF THE FINGERS BETWEEN MOVING HEIGHT ADJUSTMENT LEVER AND THE MOWER HOUSING.