

Original operating Instructions  
Garden Pump

**Einhell**<sup>®</sup>

7

Art.-Nr.: 41.766.42

I.-Nr.: 11010

BG-AW **6036**



☞ Read and follow the operating instructions and safety information before using for the first time.

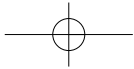
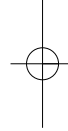
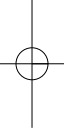

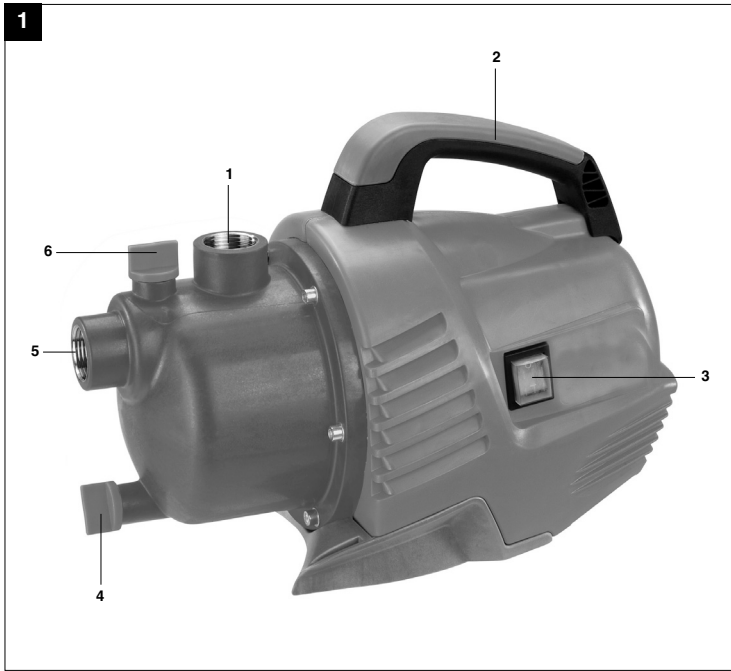

**GB****⚠ Important!**

When using equipment, a few safety precautions must be observed to avoid injuries and damage. Please read the complete operating manual with due care. Keep this manual in a safe place, so that the information is available at all times. If you give the equipment to any other person, give them these operating instructions as well.  
We accept no liability for damage or accidents which arise due to non-observance of these instructions and the safety information.

**1. Safety regulations****⚠ Caution!**

**In stagnant water bodies, garden ponds, swimming ponds and their surrounding areas the unit may only be used with an earth-leakage circuit breaker with an actuating rated current of up to 30 mA (according to VDE 0100 Part 702 and 738).**

**The equipment is not designed for use in swimming pools and paddling pools of any kind or other bodies of water in which people or animals may be present during operation. It is prohibited to operate the equipment if a person or animal is in the danger area. Ask your electrician!**

This equipment is not designed to be used by people (including children) with limited physical, sensory or mental capacities or those with no experience and/or knowledge unless they are supervised by a person who is responsible for their safety or they have received instructions from such a person in how to use the equipment safely. Children must always be supervised in order to ensure that they do not play with the equipment.

**Important!**

- Always inspect the equipment visually before using it. Do not use the equipment if safety devices are damaged or worn. Never disable safety devices.
- Use the equipment only for the purposes indicated in these operating instructions.
- You are responsible for safety in the work area.
- If the cable or plug is damaged by external influences, the cable may not be repaired. The cable must be replaced by a new one. This work may only be carried out by a trained electrician.
- The voltage of 230 V alternating voltage specified on the rating plate must be the same as the mains

voltage.

- Never use the power cable to lift, transport or secure the equipment.
- Ensure that the electrical plug connections are in areas that are not at risk of flooding or protect them from moisture.
- Pull the mains plug before starting any work on the equipment.
- Do not expose the equipment to a direct jet of water.
- The operator is responsible for complying with local safety and installation regulations. (Ask an electrician if you are in any doubt.)
- Consequential damage caused by flooded rooms in the event of the equipment suffering faults must be prevented by the user by means of suitable measures (for example installing alarm systems or a reserve pump, etc.).
- In the event of a failure, repair work may only be carried out by an electrician or by ISC after sales service personnel.
- The equipment must never run dry or be used when the intake line is closed fully. The manufacturer's warranty does not cover damage caused to the equipment as a result of running it dry.
- The pump must not be used to operate swimming pools.
- The equipment must not be installed in the drinking water pipe line.

**⚠ CAUTION!****Read all safety regulations and instructions.**

Any errors made in following the safety regulations and instructions may result in an electric shock, fire and/or serious injury.

**Keep all safety regulations and instructions in a safe place for future use.**

**2. Layout and items supplied (Fig. 1)**

1. Pressure connector
2. Carry handle
3. Power switch
4. Water drain screw
5. Suction connector
6. Water filler screw

Not illustrated: Operating instructions

Take all parts out of the packaging and check that the equipment is complete.



### 3. Items supplied

- Open the packaging and take out the equipment with care.
- Remove the packaging material and any packaging and/or transportation braces (if available).
- Check to see if all items are supplied.
- Inspect the equipment and accessories for transport damage.
- If possible, please keep the packaging until the end of the guarantee period.

#### IMPORTANT

The equipment and packaging material are not toys. Do not let children play with plastic bags, foils or small parts. There is a danger of swallowing or suffocating!

### 4. Proper use

#### Applications

- Irrigation and watering of green areas, vegetable beds and gardens.
- Operation of lawn sprinklers.
- For drawing water from ponds, streams, rainwater butts, rainwater cisterns and springs
- For supplying service water

#### Transport media:

- For the pumping of clear water (fresh water), rainwater or light suds/service water.
- The maximum temperature of the fluid must not exceed +35°C if the equipment is operated permanently.
- Do not use the equipment to pump inflammable, gassing or explosive fluids.
- The pumping of aggressive liquids (acids, alkalis, silo seepage etc.) as well as liquids with abrasive substances (sand) must likewise be avoided.

The equipment is to be used only for its prescribed purpose. Any other use is deemed to be a case of misuse. The user / operator and not the manufacturer will be liable for any damage or injuries of any kind caused as a result of this.

Please note that our equipment has not been designed for use in commercial, trade or industrial applications. Our warranty will be voided if the machine is used in commercial, trade or industrial businesses or for equivalent purposes.

### 5. Technical data

Mains connection	240 V ~ 50 Hz
Power rating	650 W
Pumping rate	3600 l/h
Max. delivery head	36 m
Max. delivery pressure	0.36 MPa (3.6 bar)
Max. suction height	8 m
Pressure and suction connector	33,3 mm (R11G)
Max. water temperature	35 °C

### 6. Before putting the equipment into operation

#### 6.1 Connecting the intake line

- The intake hose or pipe should have a minimum diameter of 25 mm (1"); a diameter of 32 mm (1 1/4") is recommended for suction heights exceeding 5 m.
- The intake hose used should have an intake valve. If the intake valve cannot be used, a check valve should be installed in the intake line.
- Position the intake line so that it rises from the water withdrawal point to the equipment. Avoid positioning the suction pipe higher than the pump, as this would delay the escape of air bubbles from the suction pipe and impede the priming process.
- Install the intake and discharge lines in such a way that they do not exert any mechanical pressure on the equipment.
- The intake valve should be low enough in the water to ensure that if the water level falls, the equipment will not run dry.
- A leaking intake line will draw in air and therefore not draw in any water.

#### 6.2 Connecting the discharge line

- The discharge line (min. 19 mm (3/4")) must be connected to the 33.3 mm (R11G) female thread discharge line connector of the equipment either directly or with the aid of a threaded nipple.
- With the right couplings it is also possible, of course, to use a 13 mm (1/2") delivery hose. The smaller delivery hose results in a lower delivery rate.
- During the priming operation, fully open any shut-off mechanisms (spray nozzles, valves, etc.) in the pressure line so that the air can escape without obstruction.

**GB****6.3 Electrical connections**

- Connect the appliance to a 230 V ~ 50 Hz socket-outlet with earthing contact. Minimum fuse 10 ampere.
- A built-in thermostat protects the motor from overloading and blocking. The pump is switched off automatically by the thermostat if overheating occurs and is switched on again automatically after cooling.

**7. Operation**

- Install the equipment on a solid and level surface.
- Attach the intake line ready for use.
- Fill the pump with water at the pressure connection.
- All shut-off devices in the pressure line (spray nozzles, valves etc.) must be fully opened when priming so that any air in the intake line can escape.
- Connect the mains cable.
- Switch on the equipment with the power switch (3) - water can be suctioned in for up to 5 minutes (maximum suction height).
- After finishing the work, switch off the equipment with the power switch (3).

**8. Replacing the power cable**

If the power cable for this equipment is damaged, it must be replaced by the manufacturer or its after-sales service or similarly trained personnel to avoid danger.

**9. Cleaning, maintenance and ordering of spare parts**

The equipment is almost completely maintenance free. In order to ensure a long service life, however, we recommend that you regularly check and care for the product.

**Important!**

The equipment must be disconnected from the power supply (pull the power plug) prior to performing any maintenance.

**9.1 Servicing**

- If the equipment becomes clogged, connect the discharge line to the water line and disconnect the suction hose. Open the water line. Switch on the equipment several times for approx.

two seconds. This should resolve the majority of clog-related problems.

- Replacing the mains cable: **Important: Disconnect the equipment from the power supply! A defective mains cable may only be replaced by a qualified electrician.**
- There are no parts inside the equipment which require additional maintenance.

**9.2 Storage**

- If the pump is not going to be used for a long time or has to be removed for the winter months, rinse it out with water, empty it completely and allow it to dry.
- The equipment must be completely drained before it is subjected to frost.
- After long stoppages, make sure the rotor turns correctly by briefly switching the pump on and off.

**9.3 Ordering replacement parts:**

Please quote the following data when ordering replacement parts:

- Type of machine
- Article number of the machine
- Identification number of the machine
- Replacement part number of the part required

For our latest prices and information please go to [www.isc-gmbh.info](http://www.isc-gmbh.info)

**10. Storage**

Store the equipment and accessories out of children's reach in a dark and dry place at above freezing temperature. The ideal storage temperature is between 5 and 30 °C. Store the electric tool in its original packaging.

**11. Disposal and recycling**

The unit is supplied in packaging to prevent its being damaged in transit. This packaging is raw material and can therefore be reused or can be returned to the raw material system.

The unit and its accessories are made of various types of material, such as metal and plastic. Defective components must be disposed of as special waste. Ask your dealer or your local council.

## 12. Troubleshooting guide

Faults	Cause	Remedy
Motor fails to start up	<ul style="list-style-type: none"> <li>- No mains voltage</li> <li>- Pump rotor blocked -thermostat switched off</li> </ul>	<ul style="list-style-type: none"> <li>- Check voltage</li> <li>- Dismantle and clean pump</li> </ul>
No intake	<ul style="list-style-type: none"> <li>- Pump chamber without water connection</li> <li>- Air in intake line air-tight</li> <li>- Max. suction height exceeded</li> </ul>	<ul style="list-style-type: none"> <li>- Fill water into intake</li> <li>- Make sure intake line is close</li> <li>- Check suction height</li> </ul>
Inadequate delivery rate	<ul style="list-style-type: none"> <li>- Suction height too high</li> <li>- Strainer dirty</li> <li>- Water level falling rapidly</li> <li>- Pump performance diminished by contaminants part</li> </ul>	<ul style="list-style-type: none"> <li>- Check suction height</li> <li>- Clean strainer</li> <li>- Place the suction hose at a deeper level</li> <li>- Clean pump and replace wearing</li> </ul>
Thermostat switches pump off	<ul style="list-style-type: none"> <li>- Motor overloaded - friction caused by foreign substances too high</li> </ul>	<ul style="list-style-type: none"> <li>- Dismantle and clean pump. Prevent intake of foreign substances (filter)</li> </ul>



Ⓢ For EU countries only

Never place any electric tools in your household refuse.

To comply with European Directive 2002/96/EC concerning old electric and electronic equipment and its implementation in national laws, old electric tools have to be separated from other waste and disposed of in an environment-friendly fashion, e.g. by taking to a recycling depot.

Recycling alternative to the demand to return electrical devices:

As an alternative to returning the electrical device, the owner is obliged to cooperate in ensuring that the device is properly recycled if ownership is relinquished. This can also be done by handing over the used device to a returns center, which will dispose of it in accordance with national commercial and industrial waste management legislation. This does not apply to the accessories and auxiliary equipment without any electrical components which are included with the used device.



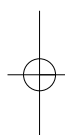
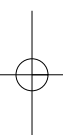

©  
The reprinting or reproduction by any other means, in whole or in part,  
of documentation and papers accompanying products is permitted only  
with the express consent of ISC GmbH.

© Technical changes subject to change

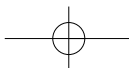





# **GUARANTEE CERTIFICATE**

Dear Customer,

All of our products undergo strict quality checks to ensure that they reach you in perfect condition. In the unlikely event that your device develops a fault, please contact our service department at the address shown on this guarantee card. Of course, if you would prefer to call us then we are also happy to offer our assistance under the service number printed below. Please note the following terms under which guarantee claims can be made:

1. These guarantee terms cover additional guarantee rights and do not affect your statutory warranty rights. We do not charge you for this guarantee.
2. Our guarantee only covers problems caused by material or manufacturing defects, and it is restricted to the rectification of these defects or replacement of the device. Please note that our devices have not been designed for use in commercial, trade or industrial applications. Consequently, the guarantee is invalidated if the equipment is used in commercial, trade or industrial applications or for other equivalent activities. The following are also excluded from our guarantee: compensation for transport damage, damage caused by failure to comply with the installation/assembly instructions or damage caused by unprofessional installation, failure to comply with the operating instructions (e.g. connection to the wrong mains voltage or current type), misuse or inappropriate use (such as overloading of the device or use of non-approved tools or accessories), failure to comply with the maintenance and safety regulations, ingress of foreign bodies into the device (e.g. sand, stones or dust), effects of force or external influences (e.g. damage caused by the device being dropped) and normal wear resulting from proper operation of the device. This applies in particular to rechargeable batteries for which we nevertheless issue a guarantee period of 12 months.  
  
The guarantee is rendered null and void if any attempt is made to tamper with the device.
3. The guarantee is valid for a period of 2 years starting from the purchase date of the device. Guarantee claims should be submitted before the end of the guarantee period within two weeks of the defect being noticed. No guarantee claims will be accepted after the end of the guarantee period. The original guarantee period remains applicable to the device even if repairs are carried out or parts are replaced. In such cases, the work performed or parts fitted will not result in an extension of the guarantee period, and no new guarantee will become active for the work performed or parts fitted. This also applies when an on-site service is used.
4. In order to assert your guarantee claim, please send your defective device postage-free to the address shown below. Please enclose either the original or a copy of your sales receipt or another dated proof of purchase. Please keep your sales receipt in a safe place, as it is your proof of purchase. It would help us if you could describe the nature of the problem in as much detail as possible. If the defect is covered by our guarantee then your device will either be repaired immediately and returned to you, or we will send you a new device.

Of course, we are also happy offer a chargeable repair service for any defects which are not covered by the scope of this guarantee or for units which are no longer covered. To take advantage of this service, please send the device to our service address.

**EINHELL AUSTRALIA PTY LTD**  
6/166 Wellington Street  
Collingwood VIC 3066  
Australia  
Phone: 1300 922 271

EH 10/2010 (01)