



DEMOLITION HAMMER KIT

- 1500W MOTOR
- 32 JOULES
- ANTI-VIBRATION
HANDLE



ORIGINAL INSTRUCTIONS



WARNING: Read all safety warnings and instructions before use. Failure to follow the warnings and instructions may result in electric shock, fire and/or serious injury. Save these instructions for future reference.

SPECIFICATIONS - MODEL NO. FBT-1100U

Power:	1500W
Input:	230-240V ~ 50Hz
Impact Energy:	32J
Impact Frequency:	1900/min
Breaking Capacity:	38mm
Accessory Fitment:	SDS Max
Weight:	10.8kg

KNOW YOUR PRODUCT

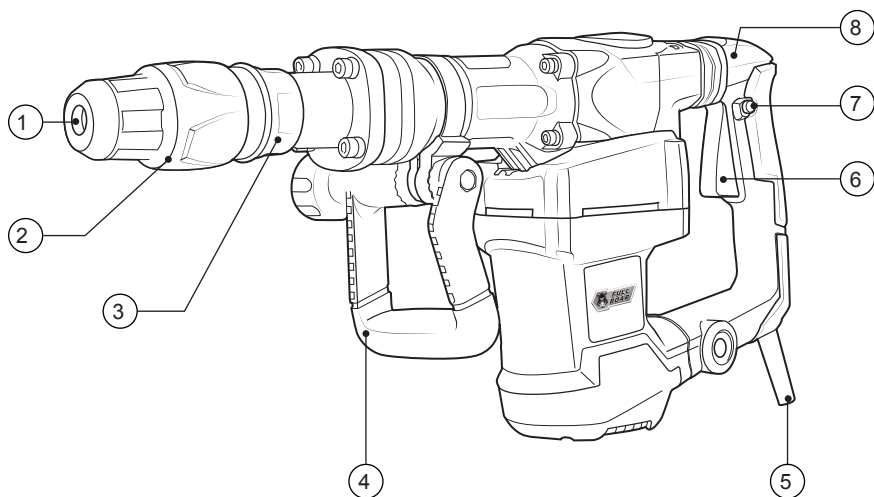

- | | |
|-----------------------------|-------------------------------|
| 1. Accessory Holder | 5. Power Cord |
| 2. Accessory Locking Sleeve | 6. On/Off Trigger |
| 3. Accessory Rotation Lock | 7. Lock-On Button |
| 4. Side Handle | 8. Anti-Vibration Rear Handle |

TABLE OF CONTENTS

SPECIFICATIONS.....	Page 02
KNOW YOUR PRODUCT.....	Page 02
INTRODUCTION.....	Page 04
SAFETY INSTRUCTIONS.....	Page 04
ASSEMBLY.....	Page 07
CONTROLS.....	Page 09
OPERATION.....	Page 10
MAINTENANCE.....	Page 11
DESCRIPTION OF SYMBOLS.....	Page 12
TROUBLE SHOOTING	Page 12
CONTENTS.....	Page 13
WARRANTY.....	Page 14

INTRODUCTION

Congratulations on purchasing your Full Boar demolition hammer kit. It has been designed for rapid breaking and chipping of concrete, block and masonry products.

Read and understand the instruction manual before operating the demolition hammer. Failure to do so could result in personal injury or equipment damage.

ELECTRICAL SAFETY

 **WARNING!** When using mains-powered tools, basic safety precautions, including the following, should always be followed to reduce risk of fire, electric shock, personal injury and material damage.

Read the whole manual carefully and make sure you know how to switch the tool off in an emergency, before operating the tool. Save these instructions and other documents supplied with this tool for future reference. The manufacturer cannot accept any liability for damage or accidents which arise due to a failure to follow these instructions and the safety information.

Before you connect the equipment to the mains supply make sure that the data on the rating plate is identical to the mains data.



This tool is double insulated therefore no earth wire is required.

The power supply for this product should be protected by a residual current device (rated at 30mA or less). A residual current device reduces the risk of electric shock.

If the supply cord of this power tool is damaged, it must be replaced by a specially prepared cord available through the service organisation.

Note: Double insulation does not take the place of normal safety precautions when operating this tool. The insulation system is for added protection against injury resulting from a possible electrical insulation failure within the tool.

Using an Extension Lead

Always use an approved extension lead suitable for the power input of this tool. Before use, inspect the extension lead for signs of damage, wear and ageing. Replace the extension lead if damaged or defective.

When using an extension lead on a reel, always unwind the lead completely. Use of an extension lead not suitable for the power input of the tool or which is damaged or defective may result in a risk of fire and electric shock.

GENERAL SAFETY INSTRUCTIONS



WARNING! Read all safety warnings and instructions before use. Failure to follow the warnings and instructions may result in electric shock, fire and/or serious injury.

Save this instruction manual for future reference. The term "power tool" in the warnings refers to your mains-operated (corded) power tool or battery-operated (cordless) power tool.

1. Work area safety

- Keep work area clean and well lit.** Cluttered or dark areas invite accidents.
- Do not operate power tools in explosive atmospheres, such as in the presence of flammable liquids, gases or dust.** Power tools create sparks which may ignite the dust or fumes.
- Keep children and bystanders away while operating a power tool.** Distractions can cause you to lose control.

2. Electrical safety

- Power tool plugs must match the outlet. Never modify the plug in any way. Do not use any adapter plugs with earthed (grounded) power tools.** Unmodified plugs and matching outlets will reduce risk of electric shock.
- Avoid body contact with earthed or grounded surfaces, such as pipes, radiators, ranges and refrigerators.** There is an increased risk of electric shock if your body is earthed or grounded.
- Do not expose power tools to rain or wet conditions.** Water entering a power tool will increase the risk of electric shock.
- Do not abuse the cord. Never use the cord for carrying, pulling or unplugging the power tool. Keep cord away from heat, oil, sharp edges or moving parts.** Damaged or entangled cords increase the risk of electric shock.
- When operating a power tool outdoors, use an extension cord suitable for outdoor use.** Use of a cord suitable for outdoor use reduces the risk of electric shock.
- If operating a power tool in a damp location is unavoidable, use a residual current device (RCD) protected supply.** Use of an RCD reduces the risk of electric shock.

3. Personal safety

- Stay alert, watch what you are doing and use common sense when operating a power tool. Do not use a power tool while you are tired or under the influence of drugs, alcohol or medication.** A moment of inattention while operating power tools may result in serious personal injury.
- Use personal protective equipment. Always wear eye protection.** Protective equipment such as a dust mask, non-skid safety shoes, hard hat, or hearing protection used for appropriate conditions, will reduce personal injuries.
- Prevent unintentional starting. Ensure the switch is in the off-position before connecting to power source and/or battery pack, picking up or carrying the tool.** Carrying power tools with your finger on the switch or energising power tools that have the switch on invites accidents.
- Remove any adjusting key or wrench before turning the power tool on.** A wrench or a key left attached to a rotating part of the power tool may result in personal injury.
- Do not overreach. Keep proper footing and balance at all times.** This enables better control of the power tool in unexpected situations.
- Dress properly. Do not wear loose clothing or jewellery. Keep your hair, clothing and gloves away from moving parts.** Loose clothes, jewellery or long hair can be caught in moving parts.
- If devices are provided for the connection of dust extraction and collection facilities, ensure these are connected and properly used.** Use of dust collection can reduce dust-related hazards.

4. Power tool use and care

- Do not force the power tool. Use the correct power tool for your application.** The correct power tool will do the job better and safer at the rate for which it was designed.
- Do not use the power tool if the switch does not turn it on and off.** Any power tool that cannot be controlled with the switch is dangerous and must be repaired.
- Disconnect the plug from the power source and/or the battery pack from the power tool before making any adjustments, changing accessories, or storing power tools.** Such preventive safety measures reduce the risk of starting the power tool accidentally.

GENERAL SAFETY INSTRUCTIONS

- d. **Store idle power tools out of the reach of children and do not allow persons unfamiliar with the power tool or these instructions to operate the power tool.** Power tools are dangerous in the hands of untrained users.
 - e. **Maintain power tools. Check for misalignment or binding of moving parts, breakage of parts and any other condition that may affect the power tool's operation. If damaged, have the power tool repaired before use.** Many accidents are caused by poorly maintained power tools.
 - f. **Keep cutting tools sharp and clean.** Properly maintained cutting tools with sharp cutting edges are less likely to bind and are easier to control.
 - g. **Use the power tool, accessories and tool bits etc. in accordance with these instructions, taking into account the working conditions and the work to be performed.** Use of the power tool for operations different from those intended could result in a hazardous situation.
- 5. Service**
- a. **Have your power tool serviced by a qualified repair person using only identical replacement parts.** This will ensure that the safety of the power tool is maintained.

DEMOLITION HAMMER SAFETY WARNINGS

- **Wear ear protectors.** Exposure to noise can cause hearing loss.
- **Use auxiliary handle(s), if supplied with the tool.** Loss of control can cause personal injury.



WARNING! This appliance is not intended for use by persons (including children) with reduced physical, sensory or mental capabilities, or lack of experience and knowledge, unless they have been given supervision or instruction concerning use of the appliance by a person responsible for their safety.

- **Hold power tool by insulated gripping surfaces, when performing an operation where the cutting accessory may contact hidden wiring or its own cord.** Cutting contacting a "live" wire may make exposed metal parts of the power tool "live" and could give the operator an electric shock.
- Before using the demolition hammer, ensure there are no concealed power cables or pipes in the cavity.
- Always use the handles, this gives you greater control if the accessory should become jammed.
- Use thick cushioned gloves and limit the exposure time by taking frequent breaks.
- Vibration caused by the hammer action may be harmful to your hands and arms.
- When removing an accessory from the tool avoid contact with skin and use proper protective gloves when grasping the bit or accessory. Accessories may be hot after prolonged use.
- Young children should be supervised to ensure that they do not play with the appliance.



WARNING! Some dust created by power sanding, sawing, grinding, drilling and other construction activities contain chemicals known to cause cancer, birth defects or other reproductive harm.

Some examples of these chemicals are:

- Lead from lead-based paints
- Crystalline silica from bricks, cement and other masonry products
- Arsenic and chromium from chemically-treated timber

The risk from such exposures vary depending on how often you do this type of work. To reduce your exposure to these chemicals; work in a well ventilated area, and work with approved safety equipment, such as those dust masks that are specifically designed to filter out microscopic particles.

Always wear eye protection and a dust mask for dusty applications and when drilling/chiselling overhead. Sanding particles can be absorbed by your eyes and inhaled easily and may cause health complications.

ASSEMBLY



WARNING! Ensure the tool has been switched off and completely stopped before performing any of the following operations.

Fitting the Side Handle

The side handle is adjustable to any position around the 360° handle collar.

1. Loosen the handle locking knob by rotating anti-clockwise to allow the handle to rotate.

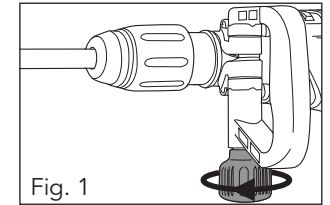

Fig. 1

2. Rotate the handle into the desired position and secure in place by rotating the handle locking knob clockwise.

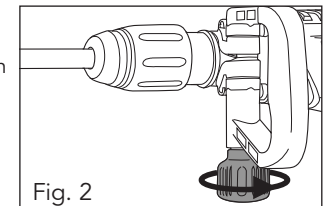

Fig. 2

ASSEMBLY

Removing and Fitting the Chisel

The Full Boar FBT-1100U comes with 2 chisel attachments that require fitting before starting the demolition hammer.



IMPORTANT! Always lubricate the accessory fitment prior to inserting them into the demolition hammer. Using your finger, apply grease sparingly to the shaft of the accessory. Lubricating the accessory will prolong the life of your tool. Non-lubrication of accessories will void your warranty.

1. Pull back the accessory locking sleeve towards the body of the tool.

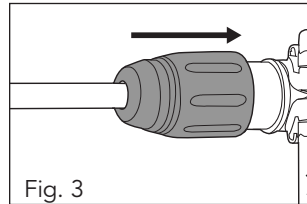

2. Slide the chisel shank out of the accessory holder. Clean the SDS max accessory shank with a dry cloth after removal.

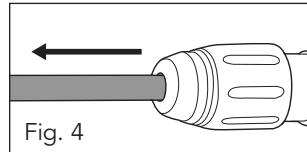

3. To fit a chisel rotate and insert the SDS max accessory into the accessory holder as far as it will go while holding the locking sleeve back.

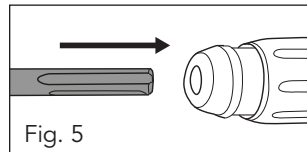

4. Secure the chisel in place by releasing the accessory locking sleeve. Pull on the attachment to check that the chisel is secure.

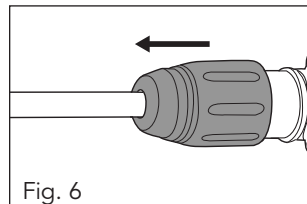

Note: The accessories will have a small amount (approx. 10-12mm) of back and forth movement from the accessory holder, this is normal.

Note: To avoid damage to the SDS max accessory holder, only use SDS max accessories. Damage caused to the SDS max accessory holder by using incorrect accessories will not be covered under warranty.



WARNING! Accessories can be hot after use, always wear gloves to prevent burns or lacerations.

CONTROLS



WARNING! Keep away from cigarettes, smoke and sparks when refuelling the demolition hammer. Always refuel in a well-ventilated location.

On / Off Trigger

1. To start the demolition hammer, squeeze and hold the on/off trigger.

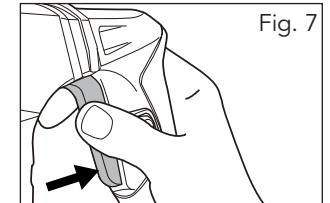

2. To stop the demolition hammer, release the on/off trigger.

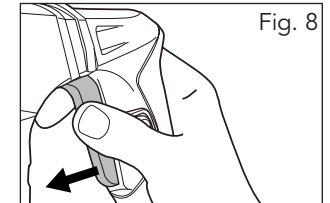

Lock-On Button

The lock-on button allows the tool to continue operating without holding the on/off trigger.

1. Start the demolition hammer by squeezing the on/off trigger.

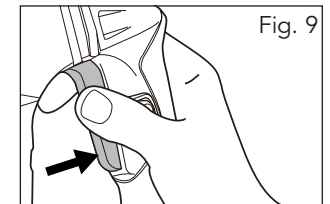

2. Press the lock-on button and then the on/off trigger can be release while the tool continues to operate.

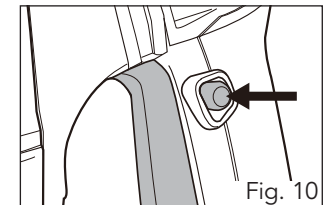

3. To stop the tool, press and release the on/off trigger.

CONTROLS

Rotating the Chisel

1. Push and hold the accessory rotation lock towards the accessory to unlock the rotation.

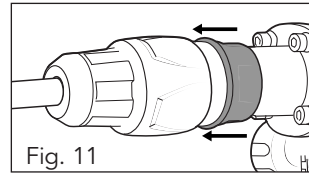

2. Rotate the accessory into the desired position.

3. Release the accessory rotation lock to allow the accessory to lock into position.

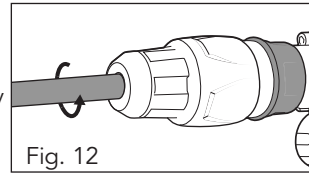

Note: Rotate the accessory after each change to ensure it is locked in position.

OPERATION

Cold Hammering

If the demolition hammer is stored for long periods of time or at cold temperatures, the lubrication may become stiff and the demolition hammer may not hammer initially or the hammering may be weak.

Should this occur, insert an accessory into the demolition hammer, turn the demolition hammer on and apply the end of the accessory against a scrap piece of concrete or timber. Turn the demolition hammer on and off every few seconds. After 15 seconds to 2 minutes, the demolition hammer should have started to hammer normally. The colder the demolition hammer, the longer it may take to warm up and function like normal.

Note: Always wait until the accessory has stopped moving before putting down the demolition hammer.

Operating the Demolition Hammer

For the best penetration rates in concrete, run the demolition hammer with a steady pressure, but do not use excessive force as this will decrease the efficiency of the demolition hammer.

Do not use the flat chisel as a "pry bar". Using the flat chisel for prying or pushing debris away from your work area will damage the flat chisel and potentially cause damage to your demolition hammer. Such damage will void your warranty.

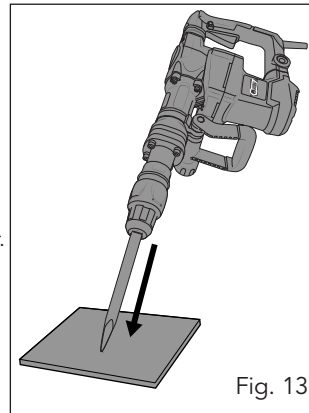

MAINTENANCE

- Keep the ventilation vents of the demolition hammer clean at all times.
- After each use, blow air through the demolition hammer housing to ensure it is free from all dust particles which may build up. Build up of dust particles may cause the demolition hammer to overheat and fail.
- If the enclosure of the demolition hammer requires cleaning, do not use solvents but a moist soft cloth only. Never let any liquid get inside the demolition hammer; never immerse any part of the demolition hammer into a liquid.

Gear Box Grease Replenishment

The grease in the gear box will require replenishment after approximately 50 hours accumulative use. After this time, add approximately 30 / 50 grams (approx 2-3 teaspoons) from the supplied tub of grease into the gear box.

First remove the grease cap from the top of the demolition hammer by using screwdriver. Once removed, add the grease through this hole. Ensure the grease cap is secured back into position prior to operation.

Carbon Brushes

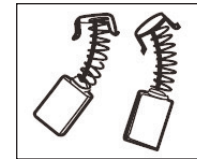

When the carbon brushes wear out, the demolition hammer will spark and/or stop. Discontinue use as soon as this happens. They should be replaced prior to recommencing use of the chipping hammer. Carbon brushes are a wearing component of the demolition hammer, therefore not covered under warranty.

Continuing to use the demolition hammer when the carbon brushes need to be replaced may cause permanent damage to the tool. Carbon brushes will wear out after many uses but when the carbon brushes need to be replaced, take the demolition hammer to an electrician or a power tool repairer for a quick and low cost replacement. Always replace both carbon brushes at the same time.

Note: Ozito Industries will not be responsible for any damage or injuries caused by the repair of the demolition hammer by an unauthorised person or by mishandling of the demolition hammer.



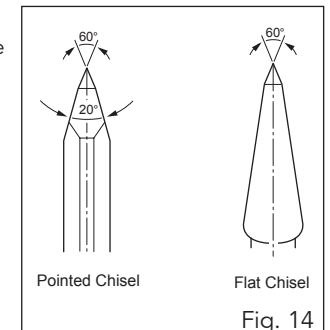

Re-sharpening the Chiselling Tools

Good results are only achieved with sharp chisels, therefore sharpen the chiselling accessories regularly. This prolongs the service life of the tools and ensures good working performance.

Sharpen chiselling tools using grinding wheels (e. g., ceramic bonded corundum wheel) with a steady supply of water. Recommended values for this purpose are shown below. Take care that no annealing coloration appears on the cutting edges, otherwise the hardness of the chiselling tools will be impaired.



DESCRIPTION OF SYMBOLS

V	Volts	Hz	Hertz
~	Alternating current	W	Watts
/min	Revolutions or reciprocation per minute	n_0	No load speed
mm	Millimetres	∅	Diameter
	Double insulated		Read instruction manual
	Warning		Wear eye protection
	Wear ear protection		

TROUBLESHOOTING

Symptom	Solution
Accessory is falling out	Ensure that the accessory is pushed in as far as possible and the locking sleeve is released.
The side handle is rotating while in use.	Ensure the handle locking knob is tight by rotating clockwise.
Accessory is jammed/ stuck in concrete during use	Pull the accessory locking sleeve back and separate the accessory from the tool. The accessory should be easily removed from concrete once it is detached from the demolition hammer.
Accessory repeatedly becomes stuck while in use	Free the accessory as described above. Refrain from penetrating too deeply with the chisel bit, as it is prone to becoming stuck when demolishing large pieces of concrete

CONTENTS

- 1 x Demolition Hammer
- 1 x Pointed Chisel
- 1 x Flat Chisel
- 1 x Kit Box

Bunnings, 489-499 Avebury Boulevard, MK9 2NW.

WARRANTY

All of our products undergo strict quality checks to ensure that they reach you in perfect condition. In the unlikely event that your device develops a fault, please contact our service department at the address shown on this guarantee card. You can also contact us by telephone using the customer service number shown. Please note the following terms under which guarantee claims can be made:

1. These warranty terms regulate additional warranty services, which the manufacturer mentioned below promises to buyers of its new products in addition to their statutory guarantee claims are not affected by this guarantee. Our guarantee is free of charge to you.

2. The warranty services only covers defects due to material or manufacturing faults on a product which you have bought from the manufacturer mentioned below are limited to either the rectification of said defects on the product or the replacement of the product, whichever we prefer.

Please note that our devices are not designed for use in commercial, trade or professional applications. A guarantee contract will not be created if the device has been used by commercial, trade or industrial business or has been exposed to similar stresses during the guarantee period.

3. The following are not covered by our guarantee:

- Damage to the device caused by a failure to follow the assembly instructions or due to incorrect installation, a failure to follow the operating instructions (for example connecting it to an incorrect mains voltage or current type) or a failure to follow the maintenance and safety instructions or by exposing the device to abnormal environmental conditions or by lack of care and maintenance.

- Damage to the device caused by abuse or incorrect use (for example overloading the device or the use of unapproved tools or accessories), ingress of foreign bodies into the device (such as sand, stones or dust, transport damage), the use of force or damage caused by external forces (for example by dropping it).

- Damage to the device or parts of the device caused by normal or natural wear or tear or by normal use of the device.

4. Your Product is guaranteed for a period of 12 months from the original date of purchase and is intended for DIY (Do It Yourself) use only. Warranty excludes consumable parts. Guarantee claims should be submitted before the end of the guarantee period within two weeks of the defect being noticed. No guarantee claims will be accepted after the end of the guarantee period. The original guarantee period remains applicable to the device even if repairs are carried out or parts are replaced. In such cases, the work performed or parts fitted will not result in an extension of the guarantee period, and no new guarantee will become active for the work performed or parts fitted. This also applies if an on-site service is used.

Your statutory rights remain unaffected, in particular any rights you have under the Consumer Rights Act 2015.

IN ORDER TO MAKE A CLAIM UNDER THIS WARRANTY YOU MUST RETURN THE PRODUCT TO THE PLACE OF PURCHASE WITH YOUR RECEIPT.

Please refer to the restrictions of this warranty concerning wearing parts, consumables and missing parts as set out in the service information in these operating instructions.

CUSTOMER SERVICE HELPLINE

GB: 0151 294 4488

IRL: 1850 882711

OZITO UK

Unit 9 Stadium Court, Wirral International Business Park, Plantation Road,
Bromborough, Wirral, CH62 3QG